



Programming Guide



VLT® AutomationDrive FC 300



design award
winner
2004

Contents

| | |
|---|-----------|
| 1. Introduction | 3 |
| Approvals | 3 |
| Symbols | 3 |
| Abbreviations | 4 |
| Definitions | 4 |
| 2. How to Program | 11 |
| The Graphical and Numerical Local Control Panels | 11 |
| How to Program on the Graphical LCP | 11 |
| The LCD Display | 12 |
| Quick Transfer of Parameter Settings between Multiple Adjustable Frequency Drives | 15 |
| Display Mode | 16 |
| Display Mode - Selection of Readouts | 16 |
| Parameter Set-up | 17 |
| Quick Menu Key Functions | 17 |
| Main Menu Mode | 20 |
| Parameter Selection | 20 |
| Changing Data | 20 |
| Changing a Text Value | 21 |
| Changing a Group of Numeric Data Values | 21 |
| Infinitely Variable Change of Numeric Data Value | 21 |
| Changing a Data Value, Step-by-Step | 22 |
| Readout and Programming of Indexed Parameters | 22 |
| How to Program on the Numerical Local Control Panel | 23 |
| Local Control Keys | 24 |
| Initialization to Default Settings | 25 |
| Parameters: Operation and Display | 28 |
| Parameters: Load and Motor | 46 |
| Parameters: Brakes | 69 |
| Parameters: Reference/Ramps | 77 |
| Parameters: Limits/Warnings | 94 |
| Parameters: Digital In/Out | 102 |
| Parameters: Analog In/Out | 123 |
| Parameters: Controllers | 133 |
| Parameters: Communications and Options | 139 |

| | |
|--|------------|
| Parameters: Profibus | 148 |
| Parameters: DeviceNet CAN Serial Communication Bus | 160 |
| Parameters: Smart Logic Control | 169 |
| Parameters: Special Functions | 190 |
| Parameters: Drive Information | 200 |
| Parameters: Data Read-outs | 210 |
| Parameters: Encoder Input | 220 |
| Parameter lists | 224 |
| Index | 251 |

1. Introduction

1

1.1.1. Approvals



1.1.2. Symbols

Symbols used in this guide.

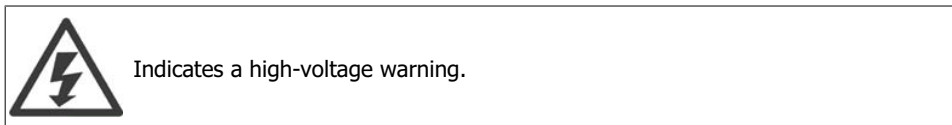
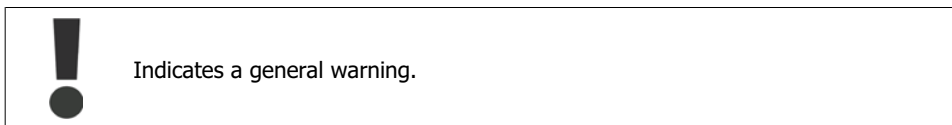
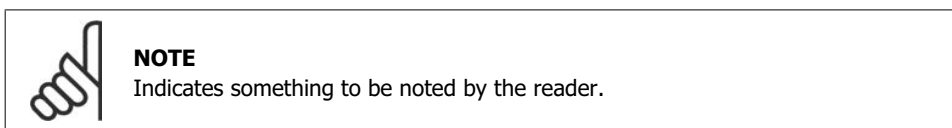

1

1.1.3. Abbreviations

| | |
|--------------------------------|-----------|
| Alternating current | AC |
| American wire gauge | AWG |
| Ampere/AMP | A |
| Automatic Motor Adaptation | AMA |
| Current limit | I_{LIM} |
| Degrees Celsius | °C |
| Direct current | DC |
| Drive Dependent | D-TYPE |
| Electro Magnetic Compatibility | EMC |
| Electronic Thermal Relay | ETR |
| drive | FC |
| Gram | g |
| Hertz | Hz |
| Kilohertz | kHz |
| Local Control Panel | LCP |
| Meter | m |
| Millihenry Inductance | mH |
| Milliampere | mA |
| Millisecond | ms |
| Minute | min |
| Motion Control Tool | MCT |
| Nanofarad | nF |
| Newton Meters | Nm |
| Nominal motor current | $I_{M,N}$ |
| Nominal motor frequency | $f_{M,N}$ |
| Nominal motor power | $P_{M,N}$ |
| Nominal motor voltage | $U_{M,N}$ |
| Parameter | par. |
| Protective Extra Low Voltage | PELV |
| Printed Circuit Board | PCB |
| Rated Inverter Output Current | I_{INV} |
| Revolutions Per Minute | RPM |
| Second | s |
| Torque limit | T_{LIM} |
| Volt | V |

1.1.4. Definitions

Drive:**D-TYPE**

Size and type of the connected drive (dependencies).

 $I_{VLT,MAX}$

The maximum output current.

 $I_{VLT,N}$

The rated output current supplied by the adjustable frequency drive.

 $U_{VLT,MAX}$

The maximum output voltage.

Input:Control command

You can start and stop the connected motor using the LCP and the digital inputs. Functions are divided into two groups.

| | |
|---------|--|
| Group 1 | Reset, Coasting stop, Reset and Coasting stop, Quick stop, DC braking, Stop and the "Off" key. |
| Group 2 | Start, Pulse start, Reversing, Start reversing, Jog and Freeze output |

Functions in group 1 have higher priority than functions in group 2.

Motor: f_{JOG}

The motor frequency when the jog function is activated (via digital terminals).

 f_M

The motor frequency.

 f_{MAX}

The maximum motor frequency.

 f_{MIN}

The minimum motor frequency.

 $f_{M,N}$

The rated motor frequency (nameplate data).

 I_M

The motor current.

 $I_{M,N}$

The rated motor current (nameplate data).

M-TYPE

Size and type of the connected motor (dependencies).

 $n_{M,N}$

The rated motor speed (nameplate data).

 $P_{M,N}$

The rated motor power (nameplate data).

 $T_{M,N}$

The rated torque (motor).

 U_M

The instantaneous motor voltage.

1

$U_{M,N}$

The rated motor voltage (nameplate data).

Break-away torque

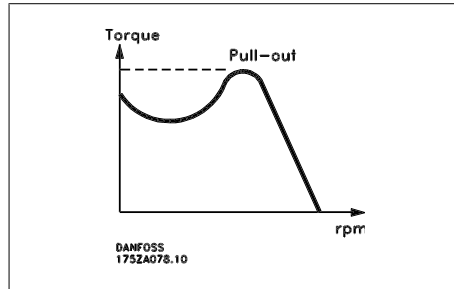

η_{VLT}

The efficiency of the adjustable frequency drive is defined as the ratio between the power output and the power input.

Start-disable command

A stop command belonging to the group 1 control commands - see this group.

Stop command

See Control commands.

References:

Analog Reference

A signal transmitted to the analog inputs 53 or 54 can be voltage or current.

Binary Reference

A signal transmitted to the serial communication port.

Preset Reference

A defined preset reference to be set from -100% to +100% of the reference range. Selection of eight preset references via the digital terminals.

Pulse Reference

A pulse frequency signal transmitted to the digital inputs (terminal 29 or 33).

Ref_{MAX}

Determines the relationship between the reference input at 100% full scale value (typically 10 V, 20 mA) and the resulting reference. The maximum reference value set in par. 3-03.

Ref_{MIN}

Determines the relationship between the reference input at 0% value (typically 0 V, 0 mA, 4 mA) and the resulting reference. The minimum reference value set in par. 3-02.

Miscellaneous:

Analog Inputs

The analog inputs are used for controlling various functions of the adjustable frequency drive.

There are two types of analog inputs:
Current input, 0-20 mA and 4-20 mA
Voltage input, 0-10 V DC (FC 301)
Voltage input, -10 - +10 V DC (FC 302).

Analog Outputs

The analog outputs can supply a signal of 0-20 mA, 4-20 mA, or a digital signal.

Automatic Motor Adaptation, AMA

AMA algorithm determines the electrical parameters for the connected motor at standstill.

Brake Resistor

The brake resistor is a module capable of absorbing the braking energy generated in regenerative braking. This regenerative braking energy increases the intermediate circuit voltage, while a brake chopper ensures that the energy is transmitted to the brake resistor.

CT Characteristics

Constant torque characteristics used for all applications such as conveyor belts, displacement pumps and cranes.

Digital Inputs

The digital inputs can be used for controlling various functions of the adjustable frequency drive.

Digital Outputs

The drive features two solid state outputs that can supply a 24 V DC (max. 40 mA) signal.

DSP

Digital Signal Processor.

ETR

Electronic Thermal Relay is a thermal load calculation based on present load and time. Its purpose is to estimate the motor temperature.

Hiperface®

Hiperface® is a registered trademark by Stegmann.

Initializing

If initializing is carried out (par. 14-22), the adjustable frequency drive returns to the default setting.

Intermittent Duty Cycle

An intermittent duty rating refers to a sequence of duty cycles. Each cycle consists of an on-load and an off-load period. The operation can be either periodic duty or non-periodic duty.

LCP

The Local Control Panel (LCP) makes up a complete interface for control and programming of the FC 300 Series. The control panel is detachable and can be installed up to 9.8 ft (3 meters) from the adjustable frequency drive, i.e. in a front panel by means of the installation kit option.

1lsb

Least significant bit.

msb

Most significant bit.

MCM

Short for Mille Circular Mil, an American measuring unit for cable cross-section. 1 MCM = 0.00079 in² [0.5067 mm²].

Online/Offline Parameters

Changes to online parameters are activated immediately after the data value is changed. Changes to offline parameters are not activated until you enter [OK] on the LCP.

Process PID

The PID regulator maintains the desired speed, pressure, temperature, etc. by adjusting the output frequency to match the varying load.

Pulse Input/Incremental Encoder

An external, digital pulse transmitter used for feeding back information on motor speed. The encoder is used in applications where great accuracy in speed control is required.

RCD

Residual Current Device.

Set-up

You can save parameter settings in four set-ups. Change between the four parameter set-ups and edit one while another set-up is active.

SFAVM

Switching pattern called Stator Flux-oriented Asynchronous Vector Modulation (par. 14-00).

Slip Compensation

The adjustable frequency drive compensates for the motor slip by giving the frequency a supplement that follows the measured motor load, thus keeping the motor speed almost constant.

Smart Logic Control (SLC)

The SLC is a sequence of user-defined actions executed when the associated user-defined events are evaluated as true by the SLC. (Parameter group 13-xx).

FC Standard Bus

Includes RS-485 bus with the FC protocol or MC protocol. See parameter 8-30.

Thermistor:

A temperature-dependent resistor placed where the temperature is to be monitored (adjustable frequency drive or motor).

Trip

A state entered in fault situations, such as when the adjustable frequency drive is subject to an overtemperature, or when the adjustable frequency drive is protecting the motor, process or

mechanism. Restart is prevented until the cause of the fault has rectified and the trip state is cancelled by activating reset, or, in some cases, by programming an automatic reset. Trip may not be used as a personal safety measure.

Trip-Locked

A state entered in fault situations when the adjustable frequency drive is protecting itself and requiring physical intervention, such as when the adjustable frequency drive is subject to a short circuit on the output. A locked trip can only be cancelled by cutting off line power, removing the cause of the fault and reconnecting the adjustable frequency drive. Restart is prevented until the trip state is cancelled by activating reset or, in some cases, by being programmed to reset automatically. Trip may not be used as a personal safety measure.

VT Characteristics

Variable torque characteristics used for pumps and fans.

VVCplus

Compared with standard voltage/frequency ratio control, voltage vector control (VVC^{plus}) improves the dynamics and the stability, both when the speed reference is changed and in relation to the load torque.

60° AVM

Switching pattern called 60° Asynchronous Vector Modulation (par. 14-00).

Power Factor

The power factor is the relation between I_1 and I_{RMS} .

$$\text{Power factor} = \frac{\sqrt{3} \times U \times I_1 \times \cos\varphi_1}{\sqrt{3} \times U \times I_{RMS}}$$

The power factor for 3-phase control:

$$= \frac{I_1 \times \cos\varphi_1}{I_{RMS}} = \frac{I_1}{I_{RMS}} \text{ since } \cos\varphi_1 = 1$$

The power factor indicates to which extent the adjustable frequency drive imposes a load on the line supply.

$$I_{RMS} = \sqrt{I_1^2 + I_5^2 + I_7^2 + \dots + I_n^2}$$

The lower the power factor, the higher the I_{RMS} for the same kW performance.

In addition, a high power factor indicates that the different harmonic currents are low. The FC 300 adjustable frequency drives' built-in DC coils produce a high power factor, which minimizes the imposed load on the line supply.



The voltage of the adjustable frequency drive is dangerous whenever connected to line power. Incorrect installation of the motor, adjustable frequency drive or serial communication bus may cause damage to the equipment, serious personal injury or death. Consequently, the instructions in this manual, as well as national and local rules and safety regulations, must be followed.

1**Safety Regulations**

1. The adjustable frequency drive must be disconnected from line power if repair work is to be carried out. Make sure that the line supply has been disconnected and that the necessary time has passed before removing motor and line plugs.
2. The [STOP/RESET] key on the control panel of the adjustable frequency drive does not disconnect the equipment from line power and is thus not to be used as a safety switch.
3. Correct protective grounding of the equipment must be established, the user must be protected against supply voltage, and the motor must be protected against overload in accordance with applicable national and local regulations.
4. The ground leakage currents are higher than 3.5 mA.
5. Protection against motor overload is not included in the factory setting. If this function is desired, set par. 1-90 to data value ETR trip or data value ETR warning.
6. Do not remove the plugs for the motor and line supply while the adjustable frequency drive is connected to line power. Make sure that the line supply has been disconnected and that the necessary time has passed before removing motor and line plugs.
7. Please note that the adjustable frequency drive has more voltage inputs than L1, L2 and L3 when load sharing (linking of DC intermediate circuit) and external 24 V DC have been installed. Make sure that all voltage inputs have been disconnected and that the necessary time has passed before commencing repair work.

2. How to Program

2

2.1. The Graphical and Numerical Local Control Panels

The easiest way to program the adjustable frequency drive is to use the Graphical Local Control Panel (LCP 102). It is necessary to consult the adjustable frequency drive Design Guide when using the Numeric Local Control Panel (LCP 101).

2.1.1. How to Program on the Graphical LCP

The following instructions are valid for the graphical LCP (LCP 102):

The control panel is divided into four functional groups:

1. Graphical display with status lines.
2. Menu keys and LEDs - changing parameters and switching between display functions.
3. Navigation keys and indicator lights (LEDs).
4. Operation keys and LEDs.

All data is displayed in a graphical LCP display, which can show up to five items of operating data while displaying [Status].

Display lines:

- a. **Status line:** Status messages displaying icons and graphics.¹
- b. **Line 1-2:** Operator data lines displaying data defined or chosen by the user. By pressing the [Status] key, up to one extra line can be added.¹
- c. **Status line:** Status messages displaying text.¹

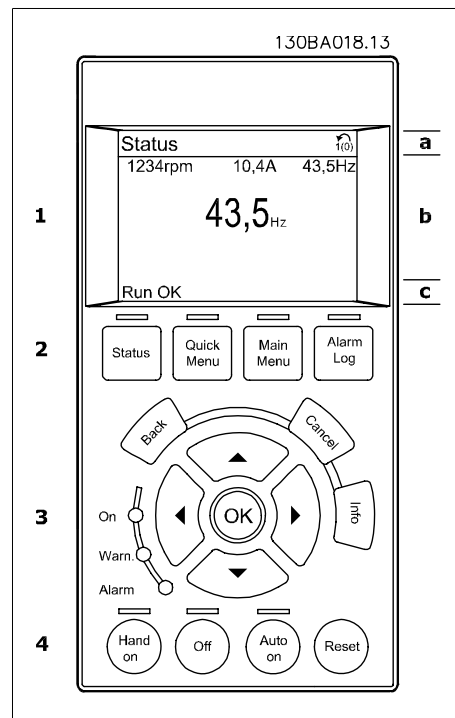

2

2.1.2. The LCD Display

The LCD display has back lighting and a total of 6 alpha-numeric lines. The display lines show the direction of rotation (arrow), the chosen Set-up and the programming Set-up. The display is divided into 3 sections:

The top section shows up to 2 measurements in normal operating status.

The top line in the **middle section** shows up to 5 measurements with the related unit, regardless of status (except in the case of an alarm/warning).

The bottom section always shows the state of the adjustable frequency drive in status mode.

The active set-up (selected as the active set-up in par. 0-10) is shown. When programming another set-up than the active set-up, the number of the programmed set-up appears to the right.

Display Contrast Adjustment

Press [status] and [▲] for a darker display

Press [status] and [▼] for a brighter display

Most FC 300 parameter set-ups can be changed immediately via the control panel, unless a password has been created via par. 0-60 *Main Menu Password* or via par. 0-65 *Quick Menu Password*.

LEDs (LEDs):

If certain threshold values are exceeded, the alarm and/or warning LED lights up. A status and alarm text appear on the control panel.

The ON LED is activated when the adjustable frequency drive receives line voltage, or via a DC bus terminal or 24 V external supply. At the same time, the back light is on.

- Green LED/On: Control section is working.
- Yellow LED/Warn.: Indicates a warning.
- Flashing Red LED/Alarm: Indicates an alarm.

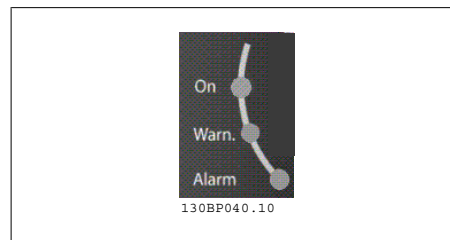
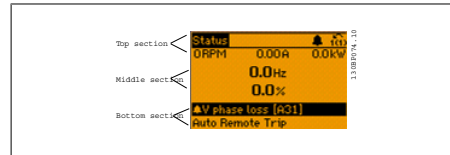

LCP keys

The control keys are divided into functions. The keys below the display and LEDs are used for parameter Set-up, including choice of display indication during normal operation.



[Status] indicates the status of the adjustable frequency drive and/or the motor. You can choose between 3 different readouts by pressing the **[Status]** key: 5 line readouts, 4 line readouts or smart logic control.

Use **[Status]** for selecting the mode of display or for changing back to display mode from either the quick menu mode, the main menu mode or alarm mode. Also use the **[Status]** key to toggle single or double readout mode.

[Quick Menu] allows quick access to different quick menus such as:

- My Personal Menu
- Quick Set-up
- Changes Made
- Loggings

Use **[Quick Menu]** for programming the parameters belonging to the Quick Menu. It is possible to switch directly between quick menu mode and main menu mode.

[Main Menu] is used for programming all parameters.

It is possible to switch directly between main menu mode and quick menu mode.

Parameter shortcut can be carried out by pressing down the **[Main Menu]** key for 3 seconds. The parameter shortcut allows direct access to any parameter.

[Alarm Log] displays an alarm list of the five latest alarms (numbered A1-A5). For additional details on a particular alarm, use the arrow keys to navigate to the alarm number and press **[OK]**. You will now receive information about the condition of your adjustable frequency drive right before entering the alarm mode.

[Back] takes you to the previous step or layer in the navigation structure.

[Cancel] cancels your last change or command as long as the display has not been changed.

[Info] supplies information about a command, parameter or function in any display window. **[Info]** provides detailed information whenever help is needed. Exit info mode by pressing either **[Info]**, **[Back]** or **[Cancel]**.



Navigation Keys

The four navigation arrows are used to navigate between the different choices available in **[Quick Menu]**, **[Main Menu]** and **[Alarm Log]**. Use the keys to move the cursor.

2

[OK] is used for choosing a parameter marked by the cursor and enabling the change of a parameter.

Local Control Key for local control is found at the bottom of the control panel.



[Hand On] enables control of the adjustable frequency drive via the LCP. [Hand on] also starts the motor and makes it possible to enter the motor speed data by using the arrow keys. The key can be selected as Enable [1] or Disable [0] via par. 0-40 [Hand on] key on LCP.

External stop signals activated by using control signals or a serial bus will override a "start" command via the LCP.

The following control signals will still be active when [Hand on] is activated:

- [Hand on] - [Off] - [Auto on]
- Reset
- Coasting stop inverse
- Reversing
- Set-up select bit 0 - Set-up select bit 1
- Stop command from serial communication
- Quick stop
- DC brake

[Off] stops the connected motor. The key can be selected as Enable [1] or Disable [0] via par. 0-41 [Off] key on LCP. If no external stop function is selected and the [Off] key is inactive, the motor can be stopped by disconnecting the voltage.

[Auto On] enables the adjustable frequency drive to be controlled via the control terminals and/or serial communication. When a start signal is applied to the control terminals and/or the bus, the adjustable frequency drive will start. The key can be selected as Enable [1] or Disable [0] via par. 0-42 [Auto on] key on LCP.

**NOTE**

An active HAND-OFF-AUTO signal via the digital inputs has higher priority than the control keys [Hand on] – [Auto on].

[Reset] is used for resetting the adjustable frequency drive after an alarm (trip). It can be selected as *Enable* [1] or *Disable* [0] via par. 0-43 *Reset Keys on LCP*.

The parameter shortcut can be carried out by holding down the [Main Menu] key for 3 seconds. The parameter shortcut allows direct access to any parameter.

2.1.3. Quick Transfer of Parameter Settings between Multiple Adjustable Frequency Drives

Once the set-up of an adjustable frequency drive is complete, we recommend that you store the data in the LCP or on a PC via the MCT 10 Set-up Software tool.

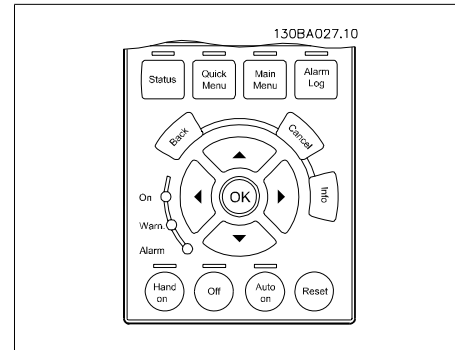
2

Data storage in LCP:

1. Go to par. 0-50 *LCP Copy*
2. Press the [OK] key.
3. Select "All to LCP"
4. Press the [OK] key.

All the parameter settings are now being stored in the LCP as indicated by the progress bar. When 100% is reached, press [OK].

You can now connect the LCP to another adjustable frequency drive and copy the parameter settings to this adjustable frequency drive as well.

Data transfer from LCP to adjustable frequency drive:

1. Go to par. 0-50 *LCP Copy*
2. Press the [OK] key.
3. Select "All from LCP."
4. Press the [OK] key.

The parameter settings stored in the LCP are now transferred to the adjustable frequency drive as indicated by the progress bar. When 100% is reached, press [OK].

2.1.4. Display Mode

In normal operation, up to 5 different operating variables can be indicated continuously in the middle section: 1.1, 1.2, and 1.3 as well as 2 and 3.

2

2.1.5. Display Mode - Selection of Readouts

It is possible to toggle between three status readout screens by pressing the [Status] key. Operating variables with different formatting are shown in each status screen - see below.

The table shows the measurements you can link to each of the operating variables. Define the links via par. 0-20, 0-21, 0-22, 0-23 and 0-24.

Each readout parameter selected in par. 0-20 to par. 0-24 has its own scale and digits after a possible decimal point. The larger the numeric value for a parameter, the fewer digits displayed after the decimal point.

Ex.: Current readout
5.25 A; 15.2 A 105 A.

| Operating variable: | Unit: |
|---|--------|
| Par. 16-00 Control Word | hex |
| Par. 16-01 Reference | [Unit] |
| Par. 16-02 Reference | % |
| Par. 16-03 Status Word | hex |
| Par. 16-05 Main Actual Value | % |
| Par. 16-10 Power | [kW] |
| Par. 16-11 Power | [HP] |
| Par. 16-12 Motor Voltage | [V] |
| Par. 16-13 Frequency | [Hz] |
| Par. 16-14 Motor Current | [A] |
| Par. 16-16 Torque | Nm |
| Par. 16-17 Speed | [rpm] |
| Par. 16-18 Motor Thermal | % |
| Par. 16-20 Motor Angle | |
| Par. 16-30 DC Link Voltage | V |
| Par. 16-32 Braking Energy / s | kW |
| Par. 16-33 Braking Energy / 2 min | kW |
| Par. 16-34 Heatsink Temp. | C |
| Par. 16-35 Inverter Thermal | % |
| Par. 16-36 Inv. Nom. Current | A |
| Par. 16-37 Inv. Max. Current | A |
| Par. 16-38 SL Control State | |
| Par. 16-39 Control Card Temp. | C |
| Par. 16-40 Logging Buffer Full | |
| Par. 16-50 External Reference | |
| Par. 16-51 Pulse Reference | |
| Par. 16-52 Feedback | [Unit] |
| Par. 16-53 DigiPot Reference | |
| Par. 16-60 Digital Input | bin |
| Par. 16-61 Terminal 53 Switch Setting | V |
| Par. 16-62 Analog Input 53 | |
| Par. 16-63 Terminal 54 Switch Setting | V |
| Par. 16-64 Analog Input 54 | |
| Par. 16-65 Analog Output 42 | [mA] |
| Par. 16-66 Digital Output | [bin] |
| Par. 16-67 Freq. Input #29 | [Hz] |
| Par. 16-68 Freq. Input #33 | [Hz] |
| Par. 16-69 Pulse Output #27 | [Hz] |
| Par. 16-70 Pulse Output #29 | [Hz] |
| Par. 16-71 Relay Output | |
| Par. 16-72 Counter A | |
| Par. 16-73 Counter B | |
| Par. 16-80 Serial Communication Bus CTW | hex |
| Par. 16-82 Serial Communication Bus REF 1 | hex |
| Par. 16-84 Comm. Option STW | hex |
| Par. 16-85 FC Port CTW 1 | hex |
| Par. 16-86 FC Port REF 1 | hex |
| Par. 16-90 Alarm Word | |
| Par. 16-92 Warning Word | |
| Par. 16-94 Ext. Status Word | |

Status screen I:

This readout state is standard after start-up or initialization.

Use [INFO] to obtain information about the measurement links to the displayed operating variables (1.1, 1.2, 1.3, 2 and 3).

See the operating variables shown on the screen in this illustration.

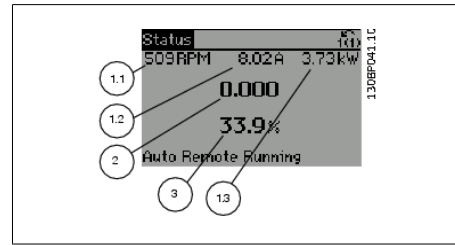

Status screen II:

See the operating variables (1.1, 1.2, 1.3 and 2) shown on the screen in this illustration.

In the example, Speed, Motor current, Motor power and Frequency are selected as variables in the first and second.

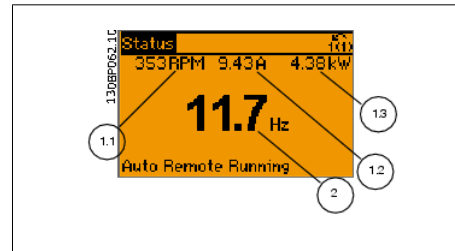

Status screen III:

This state displays the event and action of the smart logic control. For further information, see the section *Smart Logic Control*.

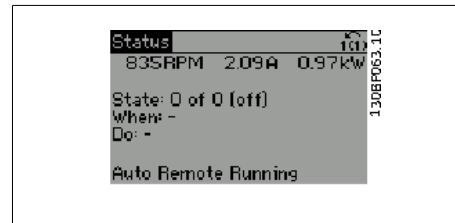

2.1.6. Parameter Set-up

The FC 300 Series can be used for practically all assignments, which is why the number of parameters is quite large. The series offers a choice between two programming modes - a main menu and a quick menu mode.

The former provides access to all parameters. The latter takes the user through a few parameters, making it possible to start operating the adjustable frequency drive.

Regardless of the mode of programming, you can change a parameter both in the main menu and quick menu modes.

2.1.7. Quick Menu Key Functions

Pressing [Quick Menus] The list indicates the different areas contained in the Quick menu.

Select *My Personal Menu* to display the chosen personal parameters. These parameters are selected in par. 0-25 *Personal Menu*. Up to 20 different parameters can be added in this menu.

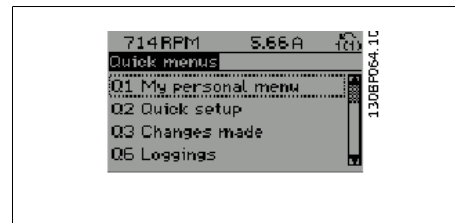

Select *Quick set-up* to go through a limited amount of parameters to get the motor running almost optimally. The default setting for the other parameters considers the desired control functions and the configuration of signal inputs/outputs (control terminals).

Parameters are selected by using the arrow keys. The parameters in the following table are accessible.

2

| Parameter | Designation | Setting |
|-----------|----------------------------------|-------------------------|
| 0-01 | Language | |
| 1-20 | Motor Power | [kW] |
| 1-22 | Motor Voltage | [V] |
| 1-23 | Motor Frequency | [Hz] |
| 1-24 | Motor Current | [A] |
| 1-25 | Motor Nominal Speed | [rpm] |
| 5-12 | Terminal 27 Digital Input | [0] No function* |
| 1-29 | Automatic Motor Adaptation (AMA) | [1] Enable complete AMA |
| 3-02 | Minimum Reference | [rpm] |
| 3-03 | Maximum Reference | [rpm] |
| 3-41 | Ramp 1 Ramp-up Time | [sec] |
| 3-42 | Ramp 1 Ramp-down Time | [sec] |
| 3-13 | Reference Site | |

* If terminal 27 is set to "no function," no connection to +24 V on terminal 27 is necessary.

Select *Changes made* to get information about:

- The last 10 changes. Use the [▲] [▼] navigation keys to scroll between the last 10 changed parameters.
- The changes made since default setting.

Select *Loggings* to get information about the display line readouts. The information is shown in graphs.

Only display parameters selected in par. 0-20 and par. 0-24 can be viewed. It is possible to store up to 120 samples in the memory for later reference.

2.1.8. Initial Commissioning

The easiest way of carrying out the initial commissioning is by using the Quick Menu button and follow the quick set-up procedure using LCP 102 (read table from left to right):

2

| Press | | | |
|---------------------------------|--|---|--|
| | | Q2 Quick Menu | |
| 0-01 Language | | Set language | |
| 1-20 Motor power | | Set motor nameplate power | |
| 1-22 Motor voltage | | Set nameplate voltage | |
| 1-23 Motor frequency | | Set nameplate frequency | |
| 1-24 Motor current | | Set nameplate current | |
| 1-25 Motor nominal speed | | Set nameplate speed in RPM | |
| 5-12 Terminal 27 Digital Input | | If terminal default is <i>Coast inverse</i> , it is possible to change this setting to <i>No function</i> . No connection to terminal 27 is then needed for running AMA | |
| 1-29 Automatic Motor Adaptation | | Set desired AMA function. Enabling complete AMA is recommended | |
| 3-02 Minimum reference | | Set the minimum speed of the motor shaft | |
| 3-03 Maximum Reference | | Set the maximum speed of the motor shaft | |
| 3-41 Ramp1 up time | | Set the ramping-up time with reference to the nominal motor speed (set in par. 1-25) | |
| 3-42 Ramp1 down time | | Set the ramping-down time with reference to the nominal motor speed (set in par. 1-25) | |
| 3-13 Reference site | | Set the site from where the reference must work | |

2.1.9. Main Menu Mode

2

Start main menu mode by pressing the [Main Menu] key. The readout shown to the right appears on the display.

The middle and bottom sections on the display show a list of parameter groups which can be chosen by toggling the up and down buttons.

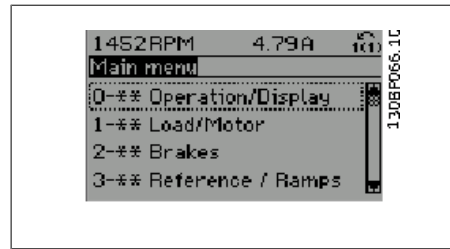

Each parameter has a name and number that remain the same regardless of the programming mode. In the main menu mode, the parameters are divided into groups. The first digit of the parameter number (from the left) indicates the parameter group number.

All parameters can be changed in the main menu. However, depending on the choice of configuration (par. 1-00), some parameters can be "missing". For example, open-loop hides all the PID parameters, and other enabled options make more parameter groups visible.

2.1.10. Parameter Selection

In main menu mode, the parameters are divided into groups. You select a parameter group using the navigation keys.

The following parameter groups are accessible:

| Group no. | Parameter group: |
|-----------|---------------------|
| 0 | Operation/Display |
| 1 | Load/Motor |
| 2 | Brakes |
| 3 | References/Ramps |
| 4 | Limits/Warnings |
| 5 | Digital In/Out |
| 6 | Analog In/Out |
| 7 | Controls |
| 8 | Comm. and Options |
| 9 | Profibus |
| 10 | CAN ser. com. bus |
| 11 | Reserved Com. 1 |
| 12 | Reserved Com. 2 |
| 13 | Smart Logic |
| 14 | Special Functions |
| 15 | Drive Information |
| 16 | Data Readouts |
| 17 | Motor Feedb. Option |

After selecting a parameter group, choose a parameter using the navigation keys.

The middle section on the display shows the parameter number and name as well as the selected parameter value.

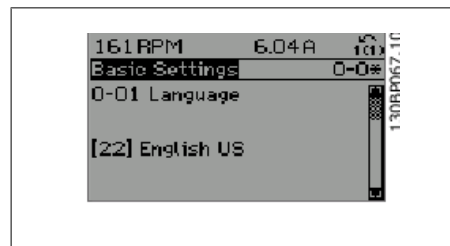

2.1.11. Changing Data

The procedure for changing data is the same whether you select a parameter in the quick menu or main menu mode. Press [OK] to change the selected parameter.

The procedure for changing data depends on whether the selected parameter represents a numerical data value or a text value.

2.1.12. Changing a Text Value

If the selected parameter is a text value, change it by using the [▲] [▼] navigation keys. The up key increases the value, and the down key decreases the value. Place the cursor on the value you want to save and press [OK].

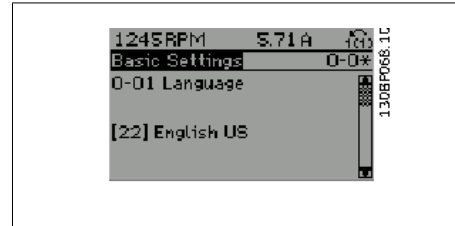

2.1.13. Changing a Group of Numeric Data Values

If the chosen parameter represents a numeric data value, change it by using the [◀] [▶] navigation keys as well as the [▲] [▼] navigation keys. Use the [◀] [▶] navigation keys to move the cursor horizontally.

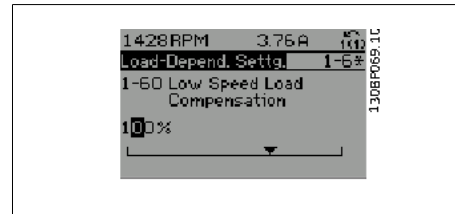

Use the [▲] [▼] navigation keys to change the data value. The up key increases the data value, and the down key reduces the data value. Place the cursor on the value you want to save and press [OK].

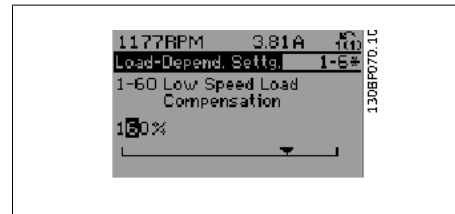

2.1.14. Infinitely Variable Change of Numeric Data Value

If the chosen parameter represents a numeric data value, select a digit using the [◀] [▶] navigation keys.

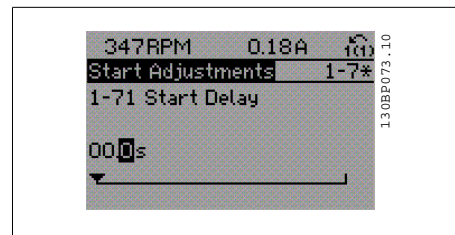

Change the selected digit to any value using the [▲] [▼] navigation keys. The chosen digit is indicated by the cursor. Place the cursor on the digit you want to save and press [OK].

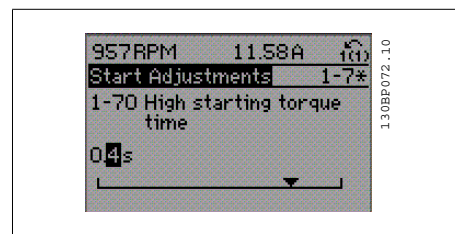

2.1.15. Changing a Data Value, Step-by-Step

2

Certain parameters can be changed step-by-step or by an infinite number of variables. This applies to *Motor Power* (par. 1-20), *Motor Voltage* (par. 1-22) and *Motor Frequency* (par. 1-23).

The parameters are changed both as a group of numeric data values and as numeric data values using an infinite number of variables.

2.1.16. Readout and Programming of Indexed Parameters

Parameters are indexed when placed in a rolling stack.

Par. 15-30 to 15-32 contain a fault log that can be read out. Choose a parameter, press [OK], and use the [▲] [▼] navigation keys to scroll through the value log.

Use par. 3-10 as another example:

Choose the parameter, press [OK], and use the [▲] [▼] navigation keys to scroll through the indexed values. To change the parameter value, select the indexed value and press [OK]. Change the value by using the [▲] [▼] keys. Press [OK] to accept the new setting. Press [CANCEL] to abort. Press [Back] to leave the parameter.

2.1.17. How to Program on the Numerical Local Control Panel

The following instructions are valid for the Numerical LCP (LCP 101).
The control panel is divided into four functional groups:

1. Numerical display.
2. Menu keys and LEDs - changing parameters and switching between display functions.
3. Navigation keys and LEDs.
4. Operation keys and LEDs.

Display line:

Status line: Status messages displaying icons and numeric value.

LEDs:

- Green LED/On: Indicates if control section is on.
- Yellow LED/Wrn.: Indicates a warning.
- Flashing red LED/Alarm: Indicates an alarm.

LCP keys

[Menu] Select one of the following modes:

- Status
- Quick Set-up
- Main Menu

Status Mode: Displays the status of the adjustable frequency drive or the motor.
If an alarm occurs, the NLCP automatically switches to status mode.
A number of alarms can be displayed.

NOTE
Parameter copy is not possible with LCP 101 numerical local control panel.

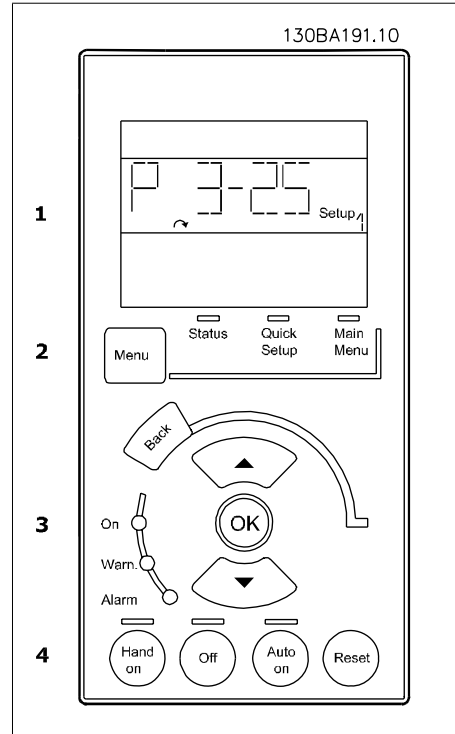

2

Main Menu/ Quick Set-up is used for programming all parameters or only the parameters in the quick menu (see also description of the LCP 102 earlier in this chapter).

The parameter values can be changed using the [▲] [▼] keys when the value is flashing. Select the main menu by pressing the [Menu] key several times.

Select the parameter group [xx-__] and press [OK].

Select the parameter [__-xx] and press [OK].

If the parameter is an array parameter, select the array number and press [OK].

Select the desired data value and press [OK].

Parameters with functional choices display values such as [1], [2], etc. For a description of the different choices, see the individual description of the parameters in the *Parameter Selection* section

[Back] for stepping backwards

Arrow [▲] [▼] keys are used for navigating between commands and within parameters.

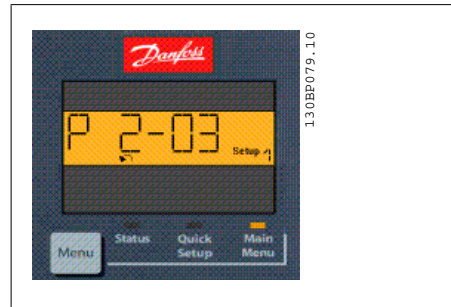

2.1.18. Local Control Keys

Keys for local control are found at the bottom of the control panel.

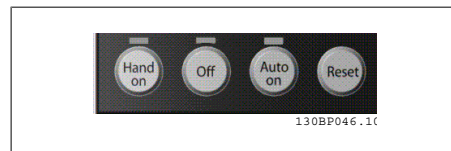

[Hand on] enables control of the adjustable frequency drive via the LCP. [Hand on] also starts the motor and makes it possible to enter the motor speed data by means of the arrow keys. The key can be selected as Enable [1] or Disable [0] via par. 0-40 *[Hand on] Key on LCP*. External stop signals activated by means of control signals or a serial bus will override a "start" command via the LCP.

The following control signals will still be active when [Hand on] is activated:

- [Hand on] - [Off] - [Auto on]
- Reset
- Coasting stop inverse
- Reversing
- Set-up select lsb - Set-up select msb
- Stop command from serial communication
- Quick stop
- DC brake

[Off] stops the connected motor. The key can be selected as Enable [1] or Disable [0] via par. 0-41 *[Off] Key on LCP*.

If no external stop function is selected and the [Off] key is inactive, the motor can be stopped by disconnecting the voltage.

[Auto on] enables the adjustable frequency drive to be controlled via the control terminals and/or serial communication. When a start signal is applied to the control terminals and/or the bus, the adjustable frequency drive will start. The key can be selected as Enable [1] or Disable [0] via par. 0-42 *[Auto on] Key on LCP*.

NOTE
An active HAND-OFF-AUTO signal via the digital inputs has higher priority than the control keys [Hand on] [Auto on].

[Reset] is used for resetting the adjustable frequency drive after an alarm (trip). It can be selected as Enable [1] or Disable [0] via par. 0-43 *Reset Keys on LCP*.

2.1.19. Initialization to Default Settings

Initialize the adjustable frequency drive using default settings in two ways:

Recommended initialization (via par. 14-22)

1. Select par. 14-22
2. Press [OK]
3. Select "Initialization"
4. Press [OK]
5. Cut off the line power supply and wait until the display turns off.
6. Reconnect the line power supply - the adjustable frequency drive is now reset.

Par. 14-22 initializes everything except:

| | |
|----------------|-------------------------------|
| 14-50 | <i>RFI 1</i> |
| 8-30 | <i>Protocol</i> |
| 8-31 | <i>Address</i> |
| 8-32 | <i>Baud Rate</i> |
| | |
| 8-35 | <i>Minimum Response Delay</i> |
| 8-36 | <i>Max Response Delay</i> |
| 8-37 | <i>Max Inter-char Delay</i> |
| 15-00 to 15-05 | Operating data |
| 15-20 to 15-22 | Historical log |
| 15-30 to 15-32 | Fault log |

Manual initialization

1. Disconnect from the power supply and wait until the display turns off.
 - 2a. Press [Status] - [Main Menu] - [OK] at the same time the LCP 102, Graphical Display is powering up.
 - 2b. Press [Menu] while the LCP 101, Numerical Display is powering up.
 3. Release the keys after 5 s.
 4. The adjustable frequency drive is now programmed according to default settings.

This parameter initializes everything except:

| | |
|-------|------------------------|
| 15-00 | <i>Operating Hours</i> |
| 15-03 | <i>Power-ups</i> |
| 15-04 | <i>Overtamps</i> |
| 15-05 | <i>Overvolts</i> |

2



NOTE

When you carry out manual initialization, you also reset serial communication, RFI filter settings (par. 14-50) and fault log settings.

2.2. Parameter Selection

Parameters for the FC 300 are grouped into various parameter groups for easy selection of the correct parameters for optimized operation of the adjustable frequency drive.

0-xx Operation and display parameters

- Basic settings, set-up handling
- Display and Local Control Panel parameters for choosing readouts, setting up selections and copying functions

1-xx Load and motor parameters, including all load- and motor-related parameters

2-xx Brake parameters

- DC brake
- Dynamic brake (resistor brake)
- Mechanical brake
- Overvoltage Control

3-xx References and ramping parameters includes DigiPot function

4-xx Limits Warnings; setting of limits and warning parameters

5-xx Digital inputs and outputs, including relay controls

6-xx Analog inputs and outputs

7-xx Controls; Setting parameters for speed and process controls

8-xx Communication and option parameters for setting of FC RS-485 and FC USB port parameters.

9-xx Profibus parameters

10-xx DeviceNet and CAN Serial Communication parameters

13-xx Smart Logic Control parameters

14-xx Special function parameters

15-xx Drive information parameters

16-xx Readout parameters

17-xx Encoder option parameters

2.3. Parameters: Operation and Display

2

2.3.1. 0-0* Operation / Display

Parameters related to the fundamental functions of the adjustable frequency drive, function of the LCP buttons and configuration of the LCP display.

2.3.2. 0-0* Basic Settings

Parameter group for basic adjustable frequency drive settings.

0-01 Language

Option:

Function:

Defines the language to be used in the display.

The adjustable frequency drive can be delivered with 4 different language packages. English and German are included in all packages. English cannot be erased or manipulated.

| | | |
|-------|---------------------|---------------------------------|
| [0] * | English UK | Part of Language packages 1 - 4 |
| [1] | German | Part of Language packages 1 - 4 |
| [2] | French | Part of Language package 1 |
| [3] | Danish | Part of Language package 1 |
| [4] | Spanish | Part of Language package 1 |
| [5] | Italian | Part of Language package 1 |
| [6] | Swedish | Part of Language package 1 |
| [7] | Dutch | Part of Language package 1 |
| [10] | Chinese | Language package 2 |
| [20] | Finnish | Part of Language package 1 |
| [22] | English US | Part of Language package 4 |
| [27] | Greek | Part of Language package 4 |
| [28] | Portuguese | Part of Language package 4 |
| [36] | Slovenian | Part of Language package 3 |
| [39] | Korean | Part of Language package 2 |
| [40] | Japanese | Part of Language package 2 |
| [41] | Turkish | Part of Language package 4 |
| [42] | Traditional Chinese | Part of Language package 2 |
| [43] | Bulgarian | Part of Language package 3 |
| [44] | Serbian | Part of Language package 3 |

| | | |
|------|-------------------|----------------------------|
| [45] | Romanian | Part of Language package 3 |
| [46] | Hungarian | Part of Language package 3 |
| [47] | Czech | Part of Language package 3 |
| [48] | Polish | Part of Language package 4 |
| [49] | Russian | Part of Language package 3 |
| [50] | Thai | Part of Language package 2 |
| [51] | Bahasa Indonesian | Part of Language package 2 |

0-02 Motor Speed Unit

Option:

Function:

This parameter cannot be adjusted while the motor is running. The display showing depends on settings in parameter 0-02 and 0-03. The default setting of parameters 0-02 and 0-03 depends on which region of the world the adjustable frequency drive is supplied to, but can be re-programmed as required.



NOTE

Changing the *Motor Speed Unit* will reset certain parameters to their initial value. It is recommended to select the motor speed unit first before modifying other parameters.

| | | |
|-------|-----|--|
| [0] * | rpm | Selects display of motor speed variables and parameters (i.e., references, feedbacks and limits) in terms of motor speed (rpm). |
| [1] | Hz | Selects display of motor speed variables and parameters (i.e., references, feedbacks and limits) in terms of output frequency to the motor (Hz). |

0-03 Regional Settings

Option:

Function:

| | | |
|-------|---------------|--|
| [0] * | International | Sets par.1-20 <i>Motor Power</i> units to kW and the default value of par. 1-23 <i>Motor Frequency</i> to 50 Hz. |
| [1] | US | Sets par.1-21 <i>Motor Power</i> units to HP and the default value of par. 1-23 <i>Motor Frequency</i> to 60 Hz. |

This parameter cannot be adjusted while the motor is running.

0-04 Operating State at Power-up (Hand)

| Option: | Function: |
|----------------------------|---|
| | Select the operating mode when reconnecting the adjustable frequency drive to the line voltage after a power-down in hand (local) operation mode. |
| [0] Resume | Restarts the adjustable frequency drive, maintaining the same local reference and the same start/stop settings (applied by [START/STOP]) as before the adjustable frequency drive was powered down. |
| [1] * Forced stop, ref=old | Restarts the adjustable frequency drive with a saved local reference, after line voltage reappears and after pressing [START]. |
| [2] Forced stop, ref = 0 | Resets the local reference to 0 upon restarting the adjustable frequency drive. |

2.3.3. 0-1* Set-up Operations

Define and control the individual parameter set-ups.

The adjustable frequency drive has four parameter set-ups that can be programmed independently of one other. This makes the adjustable frequency drive very flexible and able to solve advanced control functionality problems, often eliminating external control equipment costs. For example, these can be used to program the adjustable frequency drive to operate according to one control scheme in one set-up (motor 1 for horizontal movement, e.g.), and another control scheme in another set-up (motor 2 for vertical movement, e.g.). Alternatively, they can be used by an OEM machine builder to identically program all their factory-fitted adjustable frequency drives for different machine types within a range in order to have the same parameters; and then, during production/commissioning, to simply select a specific set-up, depending on in which machine the adjustable frequency drive is installed.

The active set-up (i.e., the set-up in which the adjustable frequency drive is currently operating) can be selected in parameter 0-10 and is displayed in the LCP. Using Multi set-up, it is possible to switch between set-ups with the adjustable frequency drive running or stopped via digital input or serial communication commands. If it is necessary to change set-ups while running, ensure that parameter 0-12 is programmed as required. Using parameter 0-11, it is possible to edit parameters within any of the set-ups while continuing the adjustable frequency drive operation in its active set-up, which can be a different set-up than that being edited. Using parameter 0-51, it is possible to copy parameter settings between the set-ups to enable quicker commissioning if similar parameter settings are required in different set-ups.

0-10 Active Set-up

| Option: | Function: |
|--------------------|--|
| | Select the set-up to control the adjustable frequency drive functions. |
| [0] Factory set-up | Cannot be changed. It contains the Danfoss data set, and can be used as a data source when returning the other set-ups to a known state. |
| [1] * Set-up 1 | <i>Set-up 1</i> [1] to <i>Set-up 4</i> [4] are the four separate parameter set-ups within which all parameters can be programmed. |

| | | |
|-----|--------------|---|
| [2] | Set-up 2 | |
| [3] | Set-up 3 | |
| [4] | Set-up 4 | |
| [9] | Multi set-up | Remote selection of set-ups using digital inputs and the serial communication port. This set-up uses the settings from par. 0-12 'This option linked to.' Stop the adjustable frequency drive before making changes to open-loop and closed-loop functions. |

Use par. 0-51 *Set-up copy* to copy a set-up to one or all other set-ups. Stop the adjustable frequency drive before switching between set-ups, where parameters marked 'not changeable during operation' have different values. To avoid conflicting settings of the same parameter within two different set-ups, link the set-ups together using par. 0-12 *This set-up linked to*. Parameters which are 'not changeable during operation' are marked FALSE in the parameter lists in the section *Parameter Lists*.

| 0-11 Edit Set-up | | |
|------------------|----------------|---|
| Option: | | Function: |
| | | Select the set-up to be edited (i.e., programmed) during operation: either the active set-up or one of the inactive set-ups. |
| [0] | Factory set-up | Cannot be edited, but it is useful as a data source for returning the other set-ups to a known state. |
| [1] * | Set-up 1 | <i>Set-up 1</i> [1] to <i>Set-up 4</i> [4] can be edited freely during operation, independently of the active set-up. |
| [2] | Set-up 2 | |
| [3] | Set-up 3 | |
| [4] | Set-up 4 | |
| [9] | Active Set-up | Can also be edited during operation. Edit the chosen set-up from a range of sources: LCP, FC RS-485, FC USB or up to five serial communication bus sites. |

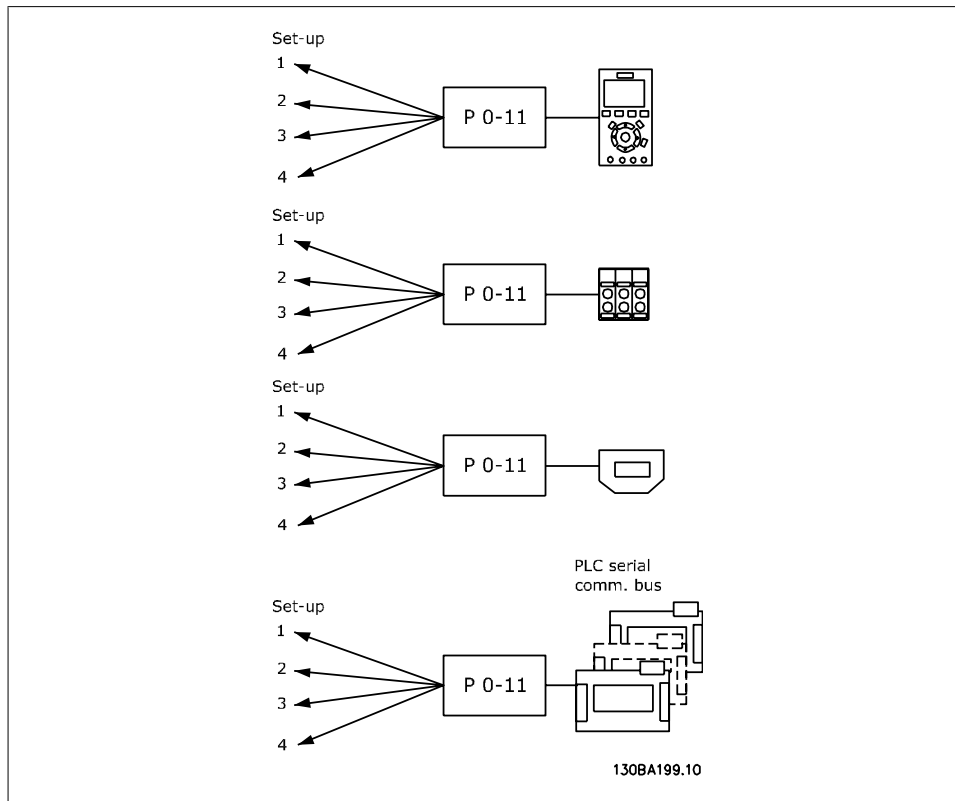

0-12 This Set-up Linked to

Option:

Function:

To enable conflict-free changes from one set-up to another during operation, link set-ups containing parameters that are not changeable during operation. The link will ensure the proper synchronization of the 'not changeable during operation' parameter values when moving from one set-up to another during operation. 'Not changeable during operation' parameters can be identified by the label FALSE in the parameter lists in the section *Parameter Lists*.

The par. 0-12 link set-up feature is used by Multi set-up in par. 0-10 *Active Set-up*. Multi set-up is used to move from one set-up to another during operation (i.e., while the motor is running). Example:

Use Multi set-up to shift from Set-up 1 to Set-up 2 while the motor is running. Program in Set-up 1 first, then ensure that Set-up 1 and Set-up 2 are synchronized (or 'linked'). Synchronization can be performed in two ways:

1. Change the edit set-up to *Set-up 2* [2] in par. 0-11 *Edit Set-up*, and set par. 0-12 *This Set-up Linked to* to *Set-up 1* [1]. This will start the linking (synchronizing) process.

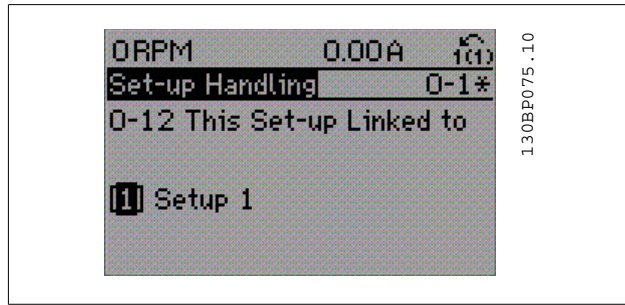

OR

2. While still in Set-up 1, copy Set-up 1 to Set-up 2. Then set par. 0-12 to *Set-up 2* [2]. This will start the linking process.

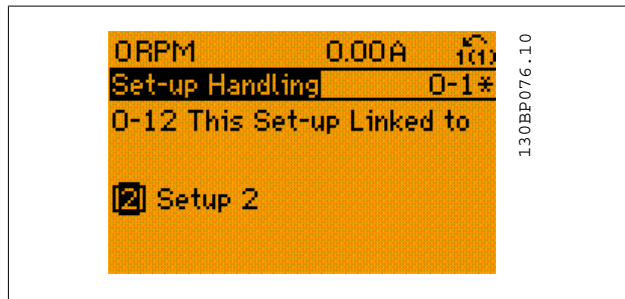

After the link is complete, par. 0-13 *Readout: Linked Set-ups* will read {1,2} to indicate that all 'not changeable during operation' parameters are now the same in Set-up 1 and Set-up 2. If there are changes to a 'not changeable during operation' parameter, such as par. 1-30 *Stator Resistance (Rs)* in Set-up 2, they will also be changed automatically in Set-up 1. A switch between Set-up 1 and Set-up 2 during operation is now possible.

| | |
|-------|------------|
| [0] * | Not linked |
| [1] | Set-up 1 |
| [2] | Set-up 2 |
| [3] | Set-up 3 |
| [4] | Set-up 4 |

0-13 Readout: Linked Set-ups

Array [5]

0* [0 - 255] View a list of all the set-ups linked by means of par. 0-12 *This Set-up Linked to*. The parameter has one index for each parameter set-up. The parameter value displayed for each index represents which set-ups are linked to that parameter set-up.

2

| Index | LCP value |
|-------|-----------|
| 0 | {0} |
| 1 | {1,2} |
| 2 | {1,2} |
| 3 | {3} |
| 4 | {4} |

2.1: Example: Set-up 1 and Set-up 2 are linked

0-14 Readout: Edit Set-ups/Channel

Range: 0* [0 - FFF.FFF.FFF] **Function:** View the setting of par. 0-11, *Edit Set-up*, for each of the four different communication channels. When the number is displayed in hex, as it is in the LCP, each number represents one channel.
 Numbers 1-4 represent a set-up number; 'F' refers to the factory settings, while 'A' means active set-up. The channels are, from right to left: LCP, FC bus, USB, HPFB1-5.
 Example: The number AAAAAA21h means that the FC bus selected Set-up 2 in par. 0-11, the LCP selected Set-up 1 and all others used the active set-up.

2.3.4. 0-2* LCP Display

Define the variables displayed in the Graphical Local Control Panel.

NOTE
Please refer to parameters 0-37, 0-38 and 0-39 for information on how to write display texts

| Select a variable for display in line 1, left position. | | |
|---|--------------------------------|----------------------------|
| [0] | None | No display value selected. |
| [953] | Profibus Word | Warning |
| [1005] | Readout Transmit Error Counter | |
| [1006] | Readout Receive Error Counter | |
| [1007] | Readout Bus Counter | Off |
| [1013] | Warning Parameter | |
| [1501] | Running Hours | |
| [1502] | kWh Counter | |
| [1600] | Control Word | Present control word |

| | | |
|--------|------------------------|--|
| [1601] | Reference [Unit] | Total reference (sum of digital/analog/preset/bus/freeze ref./catch up and slow-down) in selected unit. |
| [1602] | Reference % | Total reference (sum of digital/analog/preset/bus/freeze ref./catch up and slow-down) as a percentage. |
| [1603] | Status Word | Present status word. |
| [1605] | Main Actual Value [%] | One or more warnings in a Hex code. |
| [1609] | Custom Readout | |
| [1610] | Power [kW] | Actual power consumed by the motor in kW. |
| [1611] | Power [HP] | Actual power consumed by the motor in HP. |
| [1612] | Motor Voltage | Voltage supplied to the motor. |
| [1613] | Frequency | Motor frequency, i.e., the output frequency from the adjustable frequency drive in Hz. |
| [1614] | Motor Current | Phase current of the motor measured as effective value. |
| [1615] | Frequency [%] | Motor frequency, i.e., the output frequency from the adjustable frequency drive as a percentage. |
| [1616] | Torque | Present motor load as a percentage of the rated motor torque. |
| [1617] | * Speed [rpm] | Speed in rpm (revolutions per minute), i.e., the motor shaft speed in closed-loop. |
| [1618] | Motor Thermal | Thermal load on the motor, calculated by the ETR function. |
| [1619] | KTY Sensor Temperature | |
| [1620] | Motor Angle | |
| [1621] | Phase Angle | |
| [1622] | Torque % | |
| [1630] | DC Link Voltage | Intermediate circuit voltage in the adjustable frequency drive. |
| [1632] | BrakeEnergy/s | Present braking energy transferred to an external brake resistor. Stated as an instantaneous value. |
| [1633] | BrakeEnergy/2 min | Braking energy transferred to an external brake resistor. The mean power is calculated continuously for the latest 120 seconds. |
| [1634] | Heatsink Temp. | Present heatsink temperature of the adjustable frequency drive. The cut-out limit is $203 \pm 9^{\circ}\text{F}$ [$95 \pm 5^{\circ}\text{C}$]; cutting back in occurs at $158 \pm 9^{\circ}\text{F}$ [$70 \pm 5^{\circ}\text{C}$]. |
| [1635] | Inverter Thermal | Percentage load of the inverters. |
| [1636] | Inv. Nom. Current | Nominal current of the adjustable frequency drive. |
| [1637] | Inv. Max. Current | Maximum current of the adjustable frequency drive. |
| [1638] | SL Control State | State of the event executed by the control. |

| | | | |
|--------|----------------------------|-----|---|
| [1639] | Control Card Temp. | | Temperature of the control card. |
| [1650] | External Reference | | Sum of the external reference as a percentage, i.e., the sum of analog/pulse/bus. |
| [1651] | Pulse Reference | | Frequency in Hz connected to the digital inputs (18, 19 or 32, 33). |
| [1652] | Feedback [Unit] | | Reference value from programmed digital input(s). |
| [1653] | DigiPot Reference | | |
| [1660] | Digital Input | | Signal states form the 6 digital terminals (18, 19, 27, 29, 32 and 33). Input 18 corresponds to the bit at the far left. Signal low = 0; Signal high = 1. |
| [1661] | Terminal 53 Switch Setting | | Setting of input terminal 54. Current = 0; Voltage = 1. |
| [1662] | Analog Input 53 | | Actual value at input 53 either as a reference or protection value. |
| [1663] | Terminal 54 Switch Setting | | Setting of input terminal 54. Current = 0; Voltage = 1. |
| [1664] | Analog Input 54 | | Actual value at input 54 either as reference or protection value. |
| [1665] | Analog Output [mA] | 42 | Actual value at output 42 in mA. Use par. 6-50 to select the value to be shown. |
| [1666] | Digital Output [bin] | | Binary value of all digital outputs. |
| [1667] | Freq. Input #29 [Hz] | | Actual value of the frequency applied at terminal 29 as an impulse input. |
| [1668] | Freq. Input #33 [Hz] | | Actual value of the frequency applied at terminal 33 as an impulse input. |
| [1669] | Pulse Output [Hz] | #27 | Actual value of impulses applied to terminal 27 in digital output mode. |
| [1670] | Pulse Output [Hz] | #29 | Actual value of impulses applied to terminal 29 in digital output mode. |
| [1671] | Relay Output [bin] | | |
| [1672] | Counter A | | |
| [1673] | Counter B | | |
| [1674] | Prec. Stop Counter | | |
| [1680] | Ser. Com. Bus CTW 1 | | Control word (CTW) received from the bus master. |
| [1682] | Ser. com. bus REF 1 | | Main reference value sent with control word from the bus master. |
| [1684] | Comm. Option STW | | Extended serial communication bus option status word. |
| [1685] | FC Port CTW 1 | | Control word (CTW) received from the bus master. |
| [1686] | FC Port REF 1 | | Status word (STW) sent to the bus master. |
| [1690] | Alarm Word | | One or more alarms in a Hex code. |

| | | |
|--------|------------------------|--|
| [1691] | Alarm Word 2 | One or more alarms in a Hex code. |
| [1692] | Warning Word | One or more warnings in a Hex code. |
| [1693] | Warning Word 2 | One or more warnings in a Hex code. |
| [1694] | Ext. Status Word | One or more status conditions in a Hex code. |
| [1695] | Ext. Status Word 2 | One or more status conditions in a Hex code. |
| [3401] | PCD 1 Write to MCO | |
| [3402] | PCD 2 Write to MCO | |
| [3403] | PCD 3 Write to MCO | |
| [3404] | PCD 4 Write to MCO | |
| [3405] | PCD 5 Write to MCO | |
| [3406] | PCD 6 Write to MCO | |
| [3407] | PCD 7 Write to MCO | |
| [3408] | PCD 8 Write to MCO | |
| [3409] | PCD 9 Write to MCO | |
| [3410] | PCD 10 Write to MCO | |
| [3421] | PCD 1 Read from MCO | |
| [3422] | PCD 2 Read from MCO | |
| [3423] | PCD 3 Read from MCO | |
| [3424] | PCD 4 Read from MCO | |
| [3425] | PCD 5 Read from MCO | |
| [3426] | PCD 6 Read from MCO | |
| [3427] | PCD 7 Read from MCO | |
| [3428] | PCD 8 Read from MCO | |
| [3429] | PCD 9 Read from MCO | |
| [3430] | PCD 10 Read from MCO | |
| [3440] | Digital Inputs | |
| [3441] | Digital Outputs | |
| [3450] | Actual Position | |
| [3451] | Commanded Position | |
| [3452] | Actual Master Position | |
| [3453] | Slave Index Position | |
| [3454] | Master Index Position | |
| [3455] | Curve Position | |
| [3456] | Track Error | |
| [3457] | Synchronizing Error | |
| [3458] | Actual Velocity | |
| [3459] | Actual Master Velocity | |
| [3460] | Synchronizing Status | |
| [3461] | Axis Status | |
| [3462] | Program Status | |

[9913] Idle Time

[9914] Paramdb Requests in
Line

[1675] Analog input X30/11

[1676] Analog input X30/12

[1677] Analog output X30/8
mA

0-20 Display Line 1.1 Small

Option:

[1617] *Speed [rpm]

Function:

Select a variable for display in line 1, middle position. The options are the same as listed for par. 0-2*.

0-21 Display Line 1.2 Small

Option:

[1614] *Motor Current [A]

Function:

Select a variable for display in line 1, middle position. The options are the same as listed for par. 0-2*.

0-22 Display Line 1.3 Small

Option:

[1610] *Power [kW]

Function:

Select a variable for display in line 1, right position. The options are the same as listed for par. 0-2*.

0-23 Display Line 2 Large

Option:

[1613] *Frequency [Hz]

Function:

Select a variable for display in line 2. The options are the same as those listed in par. 0-2*.

0-24 Display Line 3 Large

Option:

[1502] *Counter [kWh]

Function:

Select a variable for display in line 2.

The options are the same as those listed for par. 0-20 *Display Line 1.1 Small*.

0-25 My Personal Menu

Array [20]

[0 - 9999] Define up to 50 parameters to appear in the Q1 Personal Menu, accessible via the [Quick Menu] key on the LCP. The parameters will be displayed in the Q1 Personal Menu in the order they are programmed into this array parameter. Delete parameters by setting the value to 0000.

For example, this can be used to provide quick, simple access to anywhere up to 20 parameters that require changing on a regular basis (for plant maintenance reasons, for example), or by an OEM to enable simple commissioning of their equipment.

2.3.5. LCP Custom Readout, Par. 0-3*

It is possible to customize the display elements for various purposes: *Custom Readout. Value proportional to speed (Linear, squared or cubed depending on unit selected in par. 0-30 *Custom Readout Unit*) *Display Text. text string stored in a parameter.

Custom Readout

The calculated value to be displayed is based on settings in par. 0-30, *Custom Readout Unit*, par. 0-31 *Custom Readout Min Value*, (linear only), par. 0-32, *Custom Readout Max Value*, par. 4-13/4-14, *Motor Speed High Limit* and actual speed.

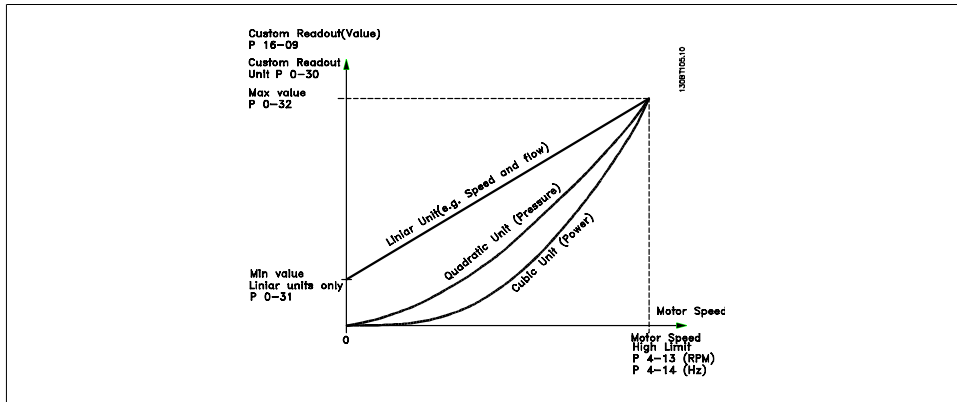

The relation will depend on the type of unit selected in par. 0-30, Custom Readout Unit:

| Unit Type | Speed Relation |
|---------------|----------------|
| Dimensionless | Linear |
| Speed | |
| Flow, volume | |
| Flow, mass | |
| Velocity | |
| Length | |
| Temperature | |
| Pressure | Quadratic |
| Power | Cubic |

0-30 Custom Readout Unit

Option:

Function:

It is possible to program a value to be shown in the display of the LCP. The value will have a linear, squared or cubed relation to speed. This relation will depend on the unit selected (see table above). The actual calculated value can be read in *Custom Readout*, par. 16-09, and/or shown in the display selecting Custom Readout [16-09] in par. 0-20 – 0-24, Display Line X.X Small (large).

| | |
|-------|---------------------|
| | Dimensionless: |
| [0] * | None |
| [1] | % |
| [5] | PPM |
| | Speed: |
| [10] | 1/min |
| [11] | rpm |
| [12] | Pulse/s |
| | Flow, volume: |
| [20] | l/s |
| [21] | l/min |
| [22] | l/h |
| [23] | m ³ /s |
| [24] | m ³ /min |
| [25] | m ³ /h |
| | Flow, mass: |
| [30] | kg/s |
| [31] | kg/min |
| [32] | kg/h |
| [33] | ton/min |
| [34] | ton/h |
| | Velocity: |
| [40] | m/s |
| [41] | m/min |
| | Length: |
| [45] | m |
| | Temperature: |
| [60] | ° C |
| | Pressure: |
| [70] | mbar |
| [71] | bar |
| [72] | Pa |
| [73] | kPa |
| [74] | m WG |

| | |
|---------------|-----------------------|
| Power: | |
| [80] | kW |
| Flow, volume: | |
| [120] | GPM |
| [121] | gal/s |
| [122] | gal/min |
| [123] | gal/h |
| [124] | CFM |
| [125] | ft ³ /sec. |
| [126] | ft ³ /min |
| [127] | ft ³ /h |
| Flow, mass: | |
| [130] | lb/sec. |
| [131] | lb/min. |
| [132] | lb/h |
| Velocity: | |
| [140] | ft/s |
| [141] | ft/min |
| Length: | |
| [145] | ft |
| Temperature: | |
| [160] | ° F |
| Pressure: | |
| [170] | psi |
| [171] | lb/in ² |
| [170] | in WG |
| [173] | ft WG |
| Power: | |
| [180] | HP |

0-31 Custom Readout Min Value

| Range: | Function: |
|------------------------|---|
| 0.00 [0 - par. 0 - 32] | This parameter sets the min. value of the custom defined readout (occurs at zero speed). Only possible to set to something other than 0 when selecting a linear unit in <i>Custom Readout Unit</i> , par. 0-30. For quadratic and cubic units, the minimum value will be 0. |

0-32 Custom Readout Max Value

| | |
|-----------------------------------|--|
| Range: | Function: |
| 100.00* [Par. 0-31 999999.99] | - This parameter sets the max value to be shown when the speed of the motor has reached the set value for <i>Motor Speed High Limit</i> , (par.4-13/4-14). |

2.3.6. LCP Keypad, 0-4*

Enable, disable and password protect individual keys on the LCP keypad.

0-40 [Hand on] Key on LCP

| | |
|----------------|---|
| Option: | Function: |
| [0] Disabled | No function |
| [1] * Enabled | [Hand on] Key enabled. |
| [2] Password | Avoid unauthorized start in hand mode. If par. 0-40 is included in the quick menu, then define the password in par. 0-65 <i>Quick Menu Password</i> . Otherwise, define the password in par. 0-60 Main Menu Password. |

0-41 [Off] Key on LCP

| | |
|----------------|--|
| Option: | Function: |
| [0] Disabled | Avoids accidental stop of the adjustable frequency drive. |
| [1] * Enabled | |
| [2] Password | Avoids unauthorized stop. If par. 0-41 is included in the quick menu, then define the password in par. 0-65 <i>Quick Menu Password</i> . |

0-42 [Auto on] Key on LCP

| | |
|----------------|--|
| Option: | Function: |
| [0] Disabled | avoids accidental start of the adjustable frequency drive in auto mode. |
| [1] * Enabled | |
| [2] Password | Avoids unauthorized start in auto mode. If par. 0-42 is included in the quick menu, then define the password in par. 0-65 <i>Quick Menu Password</i> . |

0-43 [Reset] Key on LCP

| | |
|----------------|--------------------------------|
| Option: | Function: |
| [0] Disabled | Avoids accidental alarm reset. |
| [1] * Enabled | |

- [2] Password Avoids unauthorized resetting. If par. 0-43 is included in the quick menu, then define the password in par. 0-65 *Quick Menu Password*.

2.3.7. 0-5* Copy / Save

Copy parameter settings between set-ups and to/from the LCP.

0-50 LCP Copy

| Option: | Function: |
|--------------------------|---|
| [0] * No copy | |
| [1] All to LCP | Copies all parameters in all set-ups from the adjustable frequency drive memory to the LCP memory. |
| [2] All from LCP | Copies all parameters in all set-ups from the LCP memory to the adjustable frequency drive memory. |
| [3] Size indep. from LCP | copy only the parameters that are independent of the motor size. The latter selection can be used to program several drives with the same function without disturbing motor data. |
| [4] File from MCO to LCP | |
| [5] File from LCP to MCO | |

This parameter cannot be adjusted while the motor is running.

0-51 Set-up Copy

| Option: | Function: |
|----------------------|--|
| [0] * No copy | No function |
| [1] Copy to set-up 1 | Copies all parameters in the present edit set-up (defined in par. 0-11 <i>Edit Set-up</i>) to Set-up 1. |
| [2] Copy to set-up 2 | Copies all parameters in the present edit set-up (defined in par. 0-11 <i>Edit Set-up</i>) to Set-up 2. |
| [3] Copy to set-up 3 | Copies all parameters in the present edit set-up (defined in par. 0-11 <i>Edit Set-up</i>) to Set-up 3. |
| [4] Copy to set-up 4 | Copies all parameters in the present edit set-up (defined in par. 0-11 <i>Edit Set-up</i>) to Set-up 4. |
| [9] Copy to all | Copies the parameters in the present set-up over to each of the set-ups 1 to 4. |

2.3.8. 0-6* Password

Define password access to menus.

0-60 Main Menu Password

| | |
|----------------------|---|
| Option: | Function: |
| [100] * -9999 - 9999 | Define the password for access to the main menu via the [Main Menu] key. If par. 0-61 <i>Access to Main Menu w/o Password</i> is set to <i>Full access</i> [0], this parameter will be ignored. |

0-61 Access to Main Menu w/o Password

| | |
|--------------------|---|
| Option: | Function: |
| [0] * Full access | Disables password defined in par. 0-60 <i>Main Menu Password</i> . |
| [1] Read only | Prevent unauthorized editing of main menu parameters. |
| [2] No access | Prevent unauthorized viewing and editing of main menu parameters. |
| [3] Bus: Read only | Read only functions for parameters on serial communication bus and/ or FC standard bus. |
| [4] Bus: No access | No access to parameters is allowed via serial communication bus and/or FC standard bus. |
| [5] All: Read only | Read only function for parameters on LCP, serial communication bus or FC standard bus. |
| [6] All: No access | No access from LCP, serial communication bus or FC standard bus is allowed. |

If *Full access* [0] is selected then parameters 0-60, 0-65 and 0-66 will be ignored.

0-65 Quick Menu Password

| | |
|---------------------|---|
| Range: | Function: |
| 200* [-9999 - 9999] | Define the password for access to the quick menu via the [Quick Menu] key. If par. 0-66, <i>Access to Quick Menu w/o Password</i> , is set to <i>Full access</i> [0], this parameter will be ignored. |

0-66 Access to Quick Menu w/o Password

| | |
|--------------------|---|
| Option: | Function: |
| [0] * Full access | Disables the password defined in par. 0-65, <i>Quick Menu Password</i> . |
| [1] Read only | Prevents unauthorized editing of quick menu parameters. |
| [2] No access | Prevents unauthorized viewing and editing of quick menu parameters. |
| [3] Bus: Read only | Read only functions for parameters on serial communication bus and/ or FC standard bus. |
| [4] Bus: No access | No access to parameters is allowed via serial communication bus and/or FC standard bus. |

| | | |
|-----|----------------|--|
| [5] | All: Read only | read only function for parameters on LCP, serial communication bus or FC standard bus. |
| [6] | All: No access | No access from LCP, serial communication bus or FC standard bus is allowed. |



If par. 0-61, *Access to Main Menu w/o Password*, is set to *Full access* [0], this parameter will be ignored.

0-67 Bus Password Access

| | | |
|---------------|------------|--|
| Range: | | Function: |
| 0* | [0 - 9999] | Writing to this parameter enables users to unlock the drive from bus/MCT10 |

2.4. Parameters: Load and Motor

2

2.4.1. 1-0* General Settings

Define whether the adjustable frequency drive operates in speed mode or torque mode, and whether the internal PID control should be active or not.

1-00 Configuration Mode

Option:
Function:

Select the application control principle to be used when a remote reference (i.e., via analog input or serial communication bus) is active. A remote reference can only be active when par. 3-13, *Reference Site*, is set to [0] or [1].

| | | |
|-----|-------------------|---|
| [0] | Speed open-loop | Enables speed control (without feedback signal from motor) with automatic slip compensation for almost constant speed at varying loads. Compensations are active but can be disabled in the Load/Motor par. group 1-0*. |
| [1] | Speed closed-loop | Enables encoder feedback from motor. Obtain full holding torque at 0 rpm. For increased speed accuracy, provide a feedback signal and set the speed PID control. |
| [2] | Torque | Connects the encoder speed feedback signal to the encoder input. Only possible with "Flux with motor feedback" option, par. 1-01, <i>Motor control principle</i> . |
| [3] | Process | Enables the use of process control in the adjustable frequency drive. The process control parameters are set in par. groups 7-2* and 7-3*. |

1-01 Motor Control Principle

Option:
Function:

Select which motor control principle to employ.

| | | |
|-----|-------------------------------------|---|
| [0] | U/f | special motor mode, for parallel connected motors in special motor applications. When U/f is selected, the characteristic of the control principle can be edited in par. 1-55 and 1-56. |
| [1] | VVCplus | Voltage vector control principle suitable for most applications. The main benefit of VVC ^{plus} operation is that it uses a robust motor model. |
| [2] | Flux sensorless (FC 302 only) | Flux vector control without encoder feedback, for simple installation and robustness against sudden load changes. |
| [3] | Flux w/ motor feedback(FC 302 only) | very high accuracy speed and torque control, suitable for the most demanding applications. |

The best shaft performance is normally achieved using either of the two flux vector control modes *Flux sensorless* [2] and *Flux with encoder feedback* [3].

This parameter cannot be adjusted while the motor is running.

1-02 Flux Motor Feedback Source

| Option: | Function: |
|-----------------------|--|
| | Select the interface at which to receive feedback from the motor. |
| [1] * 24 V encoder | A and B channel encoder, which can only be connected to the digital input terminals 32/33. Terminals 32/33 must be programmed to <i>No operation</i> . |
| [2] MCB 102 | Encoder module option that can be configured in par. group 17-1*. This parameter only appears in FC 302. |
| [3] MCB 103 | Optional resolver interface module which can be configured in parameter group 17-5*. |
| [4] MCO 305 encoder 1 | Encoder interface 1 of the optional programmable motion controller MCO 305. |
| [5] MCO 305 encoder 2 | Encoder interface 2 of the optional programmable motion controller MCO 305. |

This parameter cannot be adjusted while the motor is running.

1-03 Torque Characteristics

| Option: | Function: |
|------------------------|--|
| | Select the torque characteristic required. VT and AEO are both energy saving operations. |
| [0] * Constant torque | Motor shaft output provides constant torque under variable speed control. |
| [1] Variable torque | Motor shaft output provides variable torque under variable speed control. Set the variable torque level in par. 14-40 <i>VT Level</i> . |
| [2] Auto Energy Optim. | Automatically optimizes energy consumption by minimizing magnetization and frequency via par. 14-41 <i>AEO Minimum Magnetization</i> and par. 14-42 <i>Minimum AEO Frequency</i> . |

This parameter cannot be adjusted while the motor is running.

1-04 Overload Mode

| Option: | Function: |
|-------------------|--------------------------------|
| [0] * High torque | Allows up to 160% over torque. |

2

| | | |
|-----|---------------|---|
| [1] | Normal torque | For an oversized motor - allows up to 110% over torque. |
|-----|---------------|---|

This parameter cannot be adjusted while the motor is running.

1-05 Local Mode Configuration

Option:
Function:

Select which application configuration mode (par. 1-00) -- i.e., application control principle -- to use when a Local (LCP) Reference is active. A local reference can be active only when par. 3-13 *Reference Site* is set to [0] or [2]. By default, the local reference is active in hand mode only.

| | |
|-----|-----------------|
| [0] | Speed open-loop |
|-----|-----------------|

| | |
|-----|-------------------|
| [1] | Speed closed-loop |
|-----|-------------------|

| | |
|-------|-------------------|
| [2] * | As mode par. 1-00 |
|-------|-------------------|

2.4.2. 1-1* Motor selection

Parameter group for setting general motor data.

This parameter group cannot be adjusted while the motor is running.

1-10 Motor Construction

Option:
Function:

Select the motor construction type.

| | | |
|-------|--------------|--------------------------|
| [0] * | Asynchronous | For asynchronous motors. |
|-------|--------------|--------------------------|

| | | |
|-----|--------------------------------------|--|
| [1] | PM, non-salient SPM (FC 302 only) | For permanent magnet (PM) motors. Note that PM motors are divided into two groups, with either surface mounted (non-salient) or interior (salient) magnets. |
|-----|--------------------------------------|--|

Motor construction can either be asynchronous or permanent magnet (PM) motor.

2.4.3. 1-2* Motor Data

Parameter group 1-2* comprises input data from the nameplate on the connected motor.

Parameters in parameter group 1-2* cannot be adjusted while the motor is running.

NOTE

Changing the value of these parameters affects the setting of other parameters.

1-20 Motor Power

Range:

Size-re- [0.12-1,600 hp
lated* [0.09-1,200 kW]]

Function:

Enter the nominal motor power (in kW) according to the motor nameplate data. The default value corresponds to the nominal rated output of the unit.

This parameter cannot be adjusted while the motor is running. This parameter is visible in LCP if par. 0-03 is *International*[0].

1-21 Motor Power [HP]

Range:

Size-re- [0.09 - 500 HP]
lated*

Function:

Enter the nominal motor power (in HP) according to the motor nameplate data. The default value corresponds to the nominal rated output of the unit. This parameter is visible in LCP if par. 0-03 is *US*[1]

1-22 Motor Voltage

Range:

Size-re- [10 - 1000 V]
lated*

Function:

Enter the nominal motor voltage according to the motor nameplate data. The default value corresponds to the nominal rated output of the unit.

1-23 Motor Frequency

Option:

Function:

Min - Max motor frequency: 20 - 1,000 Hz
Select the motor frequency value from the motor nameplate data. If a value different from 50 Hz or 60 Hz is selected, it is necessary to adapt the load independent settings in par. 1-50 to 1-53. For 87 Hz operation with 230/400 V motors, set the nameplate data for 230 V/50 Hz. Adapt par. 4-13 *Motor Speed High Limit [RPM]* and par. 3-03 *Maximum Reference* to the 87 Hz application.

[50] * 50 Hz when parameter 0-03 = international

[60] 60 Hz when parameter 0-03 = US

1-24 Motor Current

Option:

[Motor type-dependent]

Function:

Enter the nominal motor current value from the motor nameplate data. The data are used for calculating torque, motor protection, etc.

1-25 Motor Nominal Speed

Range:

Size-re- [10 - 60,000 rpm]
lated*

Function:

Enter the nominal motor speed value from the motor nameplate data. The data are used for calculating motor compensations.

1-26 Motor Cont. Rated Torque

Range:

Size re- [1.0 - 10000.0 Nm]
lated

Function:

Enter the value from the motor nameplate data. The default value corresponds to the nominal rated output. This parameter is available when par. 1-10 *Motor Construction* is set to *PM, non salient SPM* [1], i.e., the parameter is valid for PM and non-salient SPM motors only.

1-29 Automatic Motor Adaptation (AMA)

Option:
Function:

The AMA function optimizes dynamic motor performance by automatically optimizing the advanced motor parameters (par. 1-30 to par. 1-35) while the motor is at a standstill.

Activate the AMA function by pressing [Hand on] after selecting [1] or [2]. See also the section *Automatic Motor Adaptation* in the Design Guide. After a normal sequence, the display will read: "Press [OK] to finish AMA". After pressing the [OK] key, the adjustable frequency drive is ready for operation.

This parameter cannot be adjusted while the motor is running.

[0] * OFF

[1] Enable complete AMA Performs AMA of the stator resistance R_s , the rotor resistance R_r , the stator leakage reactance X_1 , the rotor leakage reactance X_2 and the main reactance X_h . Select this option if an LC filter is used between the drive and the motor.

FC 301: The Complete AMA does not include X_h measurements for the FC 301. Instead, the X_h value is determined from the motor database. Par. 1-35 *Main Reactance (X_h)* may be adjusted to obtain optimal start performance.

[2] Enable reduced AMA Performs a reduced AMA of the stator resistance R_s in the system only.

Select the type of AMA. *Enable complete AMA* [1]

Select *Reduced AMA* [2] for a

Note:

- For the best adaptation of the adjustable frequency drive, run the AMA on a cold motor.
- AMA cannot be performed while the motor is running.
- AMA cannot be performed on permanent magnet motors.

- NOTE**
 It is important to set motor par. 1-2* Motor Data correctly, since these form part of the AMA algorithm. An AMA must be performed to achieve optimum dynamic motor performance. It may take up to 10 min, depending on the power rating of the motor.
- NOTE**
 Avoid generating external torque during AMA.
- NOTE**
 If one of the settings in par. 1-2* Motor Data is changed, par. 1-30 to 1-39, the advanced motor parameters will return to default setting.

2.4.4. 1-3* Adv. Motor Data

Parameters for advanced motor data. The motor data in par. 1-30 - par. 1-39 must match the relevant motor in order to run the motor optimally. The default settings are figures based on common motor parameter values from standard motors. If the motor parameters are not set correctly, a malfunction of the drive system may occur. If the motor data is not known, running an AMA (Automatic Motor Adaptation) is recommended. See the *Automatic Motor Adaptation* section in the Design Guide. The AMA sequence will adjust all motor parameters except the moment of inertia of the rotor and the iron loss resistance (par. 1-36). Parameters 1-3* and 1-4* cannot be adjusted while the motor is running.

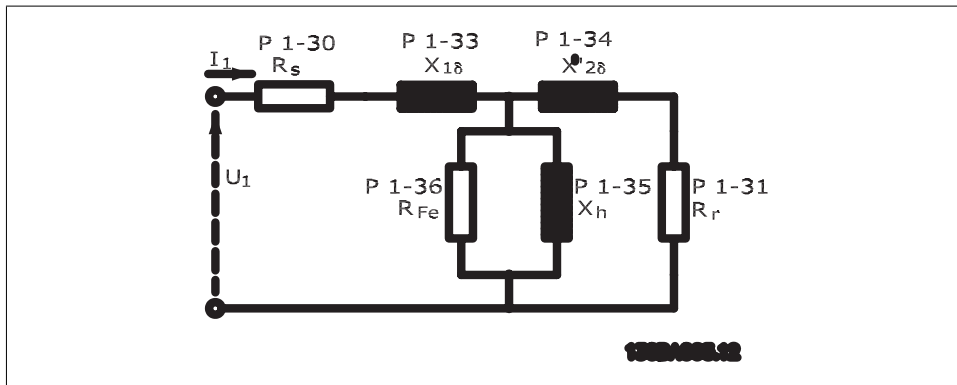

2.1: Motor equivalent diagram for an asynchronous motor

1-30 Stator Resistance (Rs)

Range:

Size-re- [Ohm]
lated

Function:

Set the stator resistance value. Enter the value from a motor data sheet or perform an AMA on a cold motor.

1-31 Rotor Resistance (R_r)

Range:

Size-re- [Ohm]
lated

Function:

Fine-tuning R_r will improve shaft performance. Set the rotor resistance value using one of these methods:

1. Run an AMA on a cold motor. The adjustable frequency drive will measure the value from the motor. All compensations are reset to 100%.
2. Enter the R_r value manually. Obtain the value from the motor supplier.
3. Use the R_r default setting. The adjustable frequency drive establishes the setting on the basis of the motor nameplate data.

1-33 Stator Leakage Reactance (X_1)

Range:

Size-re- [Ohm]
lated

Function:

Set the stator leakage reactance of the motor using one of these methods:

1. Run an AMA on a cold motor. The adjustable frequency drive will measure the value from the motor.
2. Enter the X_1 value manually. Obtain the value from the motor supplier.
3. Use the X_1 default setting. The adjustable frequency drive establishes the setting on the basis of the motor nameplate data.

1-34 Rotor Leakage Reactance (X_2)

Option:

[Size-re- Ohm
lated]

Function:

Set the rotor leakage reactance of the motor using one of these methods:

1. Run an AMA on a cold motor. The adjustable frequency drive will measure the value from the motor.
2. Enter the X_2 value manually. Obtain the value from the motor supplier.
3. Use the X_2 default setting. The adjustable frequency drive establishes the setting on the basis of the motor nameplate data.

1-35 Main Reactance (X_h)

Option:

[Size-re- Ohm
lated]

Function:

Set the main reactance of the motor using one of these methods:

1. Run an AMA on a cold motor. The adjustable frequency drive will measure the value from the motor.
2. Enter the X_h value manually. Obtain the value from the motor supplier.
3. Use the X_h default setting. The adjustable frequency drive establishes the setting on the basis of the motor nameplate data.

1-36 Iron Loss Resistance (R_{fe})

Range:

Size-re- [1 - 10.000 Ω]
lated

Function:

Enter the equivalent iron loss resistance (R_{Fe}) value to compensate for iron loss in the motor.

The R_{Fe} value cannot be found by performing an AMA.

The R_{Fe} value is especially important in torque control applications. If R_{Fe} is unknown, leave par. 1-36 on default setting.

1-37 d-axis inductance (L_d)

Range:

0.0mH [0.0 - 1000.0 mH]

Function:

Set the value of the d-axis inductance. Obtain the value from the permanent magnet motor data sheet.

This parameter is only active when par. 1-10 *Motor construction* has the value *PM, non-salient SPM* [1] (Permanent Magnet Motor).

This parameter is available for the FC 302 only.

1-39 Motor Poles

Option:

[4] * Depends on motor type Value 2-100 poles

Function:

Enter the number of motor poles.

| Poles | ~n _n @ 50 Hz | ~n _n @60 Hz |
|-------|-------------------------|------------------------|
| 2 | 2700 - 2880 | 3250 - 3460 |
| 4 | 1350 - 1450 | 1625 - 1730 |
| 6 | 700 - 960 | 840 - 1153 |

The table shows the number of poles for normal speed ranges of various motor types. Separately define motors designed for other frequencies. The motor pole value is always an even number, as it refers to the total number of poles, not pairs of poles. The adjustable frequency drive creates the initial setting of par. 1-39 based on par. 1-23 *Motor Frequency* and par. 1-25 *Motor Nominal Speed*.

1-40 Back EMF at 1000 RPM**Range:**

500 V* [10-9000 V]

Function:

Set the nominal back EMF for the motor when running at 1000 RPM. This parameter is only active when par. 1-10 *Motor construction* is set to *PM motor* [1] (Permanent Magnet Motor). This parameter is available for the FC 302 only.

**NOTE**

When using PM motors, it is recommended to use brake resistors.

1-41 Motor Angle Offset**Range:**

0* [0 - 65535]

Function:

Enter the correct offset angle between the PM motor and the index position (single-turn) of the attached encoder or resolver. The value range of 0–65535 corresponds to 0-2 * pi (radians). To obtain the offset angle value: After drive start-up, apply DC hold and enter the value of par. 16-20 *Motor Angle* into this parameter. This parameter is only active when par. 1-10 *Motor construction* is set to *PM, non-salient SPM* [1] (Permanent Magnet Motor).

2.4.5. 1-5* Load Indep. Setting

Parameters for setting the load-independent motor settings.

1-50 Motor Magnetization at Zero Speed**Range:**

100% [0 - 300 %]

Function:

Use this par. along with par. 1-51 *Min Speed Normal Magnetizing [RPM]* to obtain a different thermal load on the motor when running at low speed.

Enter a value that is a percentage of the rated magnetizing current. If the setting is too low, the torque on the motor shaft may be reduced.

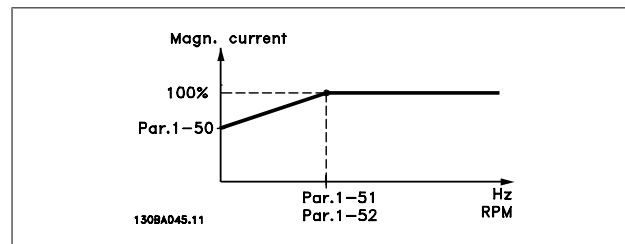

1-51 Min Speed Normal Magnetizing [RPM]

Range:
15 rpm* [10 - 300 rpm]

Function:
Set the required speed for normal magnetizing current. If the speed is set lower than the motor slip speed, par. 1-50 *Motor Magnetization at Zero Speed* and par. 1-51 are of no significance.
Use this par. along with par. 1-50. See drawing for par. 1-50.

1-52 Min Speed Normal Magnetizing [Hz]

Option:
[Size-re-0 - 250 Hz
lated]

Function:
Set the required frequency for normal magnetizing current. If the frequency is set lower than the motor slip frequency, par. 1-50 *Motor Magnetization at Zero Speed* is inactive.
Use this par. along with par. 1-50. See drawing for par. 1-50.

1-53 Model Shift Frequency

Range:
Size-re- [4.0 - 50.0 Hz]
lated

Function:
Flux Model shift
Enter the frequency value for shift between two models for determining motor speed. Choose the value based on settings in par. 1-00 *Configuration Mode* and par. 1-01 *Motor Control Principle*. There are two options: shift between Flux model 1 and Flux model 2; or shift between variable current mode and Flux model 2. This parameter is available for the FC 302 only.
This parameter cannot be adjusted while the motor is running.

Flux model 1 – Flux model 2

This model is used when par. 1-00 is set to *Speed closed-loop* [1] or *Torque* [2] and par. 1-01 is set to *Flux w/motor feedback* [3]. With this parameter it is possible to make an adjustment of the shifting point where the FC 302 changes between Flux model 1 and Flux model 2, which is useful in some sensitive speed and torque control applications.

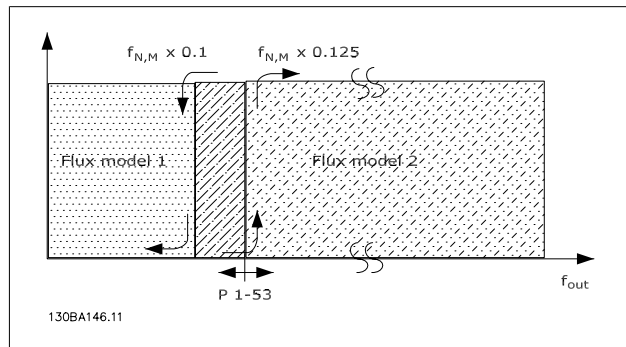

2.2: Par. 1-00 = [1] Speed closed-loop or [2] Torque, and par. 1-01 = [3] Flux w/motor feedback.

2

Variable Current - Flux model - Sensorless

This model is used when par. 1-00 is set to *Speed open-loop* [0], and par. 1-01 is set to *Flux sensorless* [2].

In speed open-loop in flux mode, the speed is determined by the current measurement.

Below $f_{norm} \times 0.1$, the drive runs on a variable current model.

Above $f_{norm} \times 0.125$ the adjustable frequency drive runs on a Flux model.

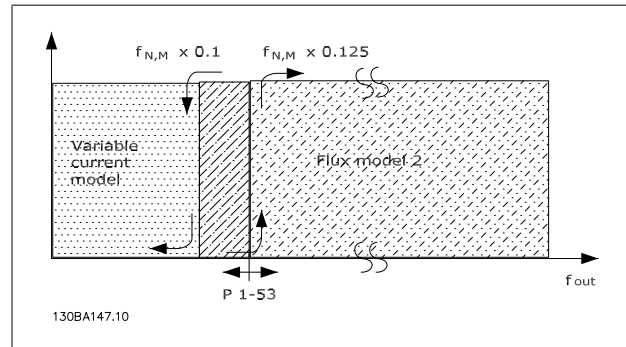

2.3: Par. 1-00 = [0] Speed open-loop
Par. 1-01 = [2] Flux sensorless

1-55 U/f Characteristic - U

Range:

Size-re- [0.0 - max. motor
lated voltage]

Function:

Enter the voltage at each frequency point in order to manually create a U/f characteristic that matches the motor.

The frequency points are defined in par. 1-56 *U/f Characteristic - F*.

This parameter is an array parameter [0-5] and is only accessible when par. 1-01 *Motor Control Principle* is set to *U/f*[0].

1-56 U/f Characteristic - F

Range:

Size-re- [0.0 - max. motor fre-
lated* quency]

Function:

Enter the frequency points in order to manually create a U/f characteristic that matches the motor.

The voltage at each point is defined in par. 1-55 *U/f Characteristic - U*.

This parameter is an array parameter [0-5] and is only accessible when par. 1-01 *Motor Control Principle* is set to *U/f*[0].

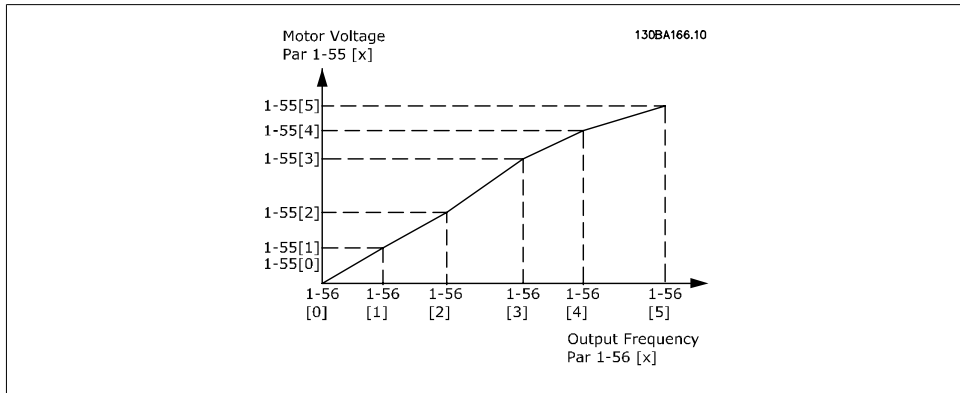

2.4.6. 1-6* Load Depend. Setting

Parameters for adjusting the load-dependent motor settings.

1-60 Low Speed Load Compensation

Range:
100%* [0 - 300%]

Function:
Enter the % value to compensate voltage in relation to load while the motor is running at low speed, and obtain the optimum U/f characteristic. The motor size determines the frequency range within which this parameter is active.

| | |
|-----------------------------|-------------|
| Motor size | Change-over |
| 0.3 - 10 HP [0.25 - 7.5 kW] | < 10 Hz |

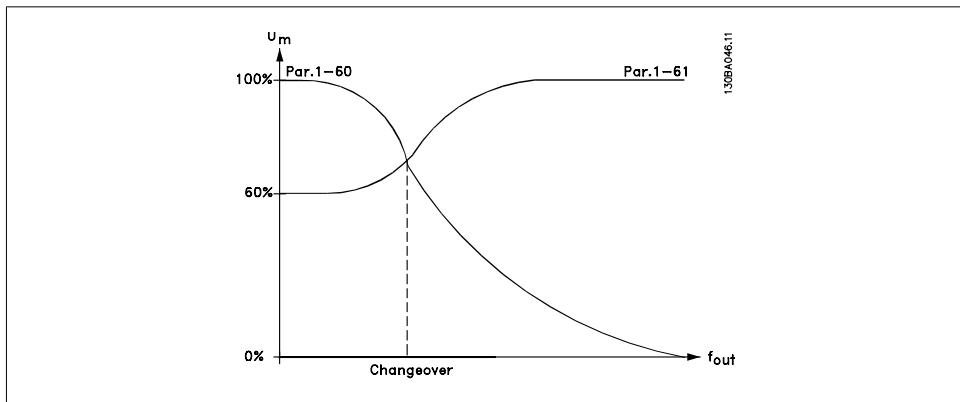

1-61 High Speed Load Compensation

Range:
100%* [0 - 300%]

Function:
Enter the % value to compensate voltage in relation to load while the motor is running at high speed, and obtain the optimum U/f characteristic. The motor size determines the frequency range within which this parameter is active.

2

| | |
|-----------------------------|-------------|
| Motor size | Change-over |
| 0.3 - 10 HP [0.25 - 7.5 kW] | > 10 Hz |

1-62 Slip Compensation

Range:

100%* [-500 - 500 %]

Function:

Enter the % value for slip compensation in order to compensate for tolerances in the value of $n_{M,N}$. Slip compensation is calculated automatically, i.e., on the basis of the rated motor speed $n_{M,N}$.

This function is not active when par. 1-00, *Configuration Mode*, is set to *Speed closed-loop* [1] or *Torque* [2] torque control with speed feedback, or when par. 1-01, *Motor Control Principle* is set to *U/f* [0] special motor mode.

1-63 Slip Compensation Time Constant

Range:

0.10 s* [0.05 - 5.00 s]

Function:

Enter the slip compensation reaction speed. A high value results in slow reaction, and a low value results in quick reaction. If low-frequency resonance problems arise, use a longer time setting.

1-64 Resonance Damping

Range:

100% * [0 - 500 %]

Function:

Enter the resonance damping value. Set par. 1-64 and par. 1-65 *Resonance Damping Time Constant* to help eliminate high-frequency resonance problems. To reduce resonance oscillation, increase the value of par. 1-64.

1-65 Resonance Damping Time Constant

Range:

5 [5 - 50 msec.] msec.*

Function:

Set par. 1-64 *Resonance Damping* and par. 1-65 to help eliminate high-frequency resonance problems. Enter the time constant that provides the best damping.

1-66 Min. Current at Low Speed

Range:

100%* [0 - 200%]

Function:

Enter the minimum motor current at low speed, see par. 1-53, *Model Shift Frequency*. Increasing this current improves motor torque at low speed.

Par. 1-66 is enabled when par. 1-00 *Configuration Mode* = *Speed open-loop* [0] only. The drive runs with constant current through the motor for speeds below 10 Hz.

For speeds above 10 Hz, the motor flux model in the drive controls the motor. Par. 4-16 *Torque Limit Motor Mode* and/or par. 4-17 *Torque Limit Generator Mode* automatically adjust par. 1-66. The parameter with the highest value adjusts par. 1-66.

The current setting in par. 1-66 is composed of the torque generating current and the magnetizing current.

Example: Set par. 4-16 *Torque Limit for Motor Mode* to 100%, and set par. 4-17 *Torque Limit for Generating Mode* to 60%. Par. 1-66 automatically adjusts to about 127%, depending on the motor size.

This parameter is available for the FC 302 only.

| 1-67 Load Type | |
|--------------------|---|
| Option: | Function: |
| [0] * Passive load | For conveyers, fan and pump applications. |
| [1] Active Load | For hoisting applications. When <i>Active Load</i> [1] is selected, set par. 1-66 Min. Current at Low Speed to a level which corresponds to maximum torque. |

This parameter is available for the FC 302 only.

| 1-68 Minimum Inertia | |
|------------------------------|--|
| Range: | Function: |
| 0.0048* [0.0001 - Par. 1-69] | Enter the minimum moment of inertia of the mechanical system. Par. 1-68 and par. 1-69 <i>Maximum Inertia</i> are used for pre-adjusting the proportional gain in the speed control; see par. 7-02 <i>Speed PID Proportional Gain</i> . This parameter is available for the FC 302 only. |

This parameter cannot be adjusted while motor is running.

| 1-69 Maximum Inertia | |
|----------------------|--|
| Range: | Function: |
| 0.0048* [0 - 0.4800] | Enter the maximum moment of inertia of the mechanical system. Par. 1-68 <i>Minimum Inertia</i> and par. 1-69 are used for pre-adjusting the proportional gain in the speed control; see par. 7-02 <i>Speed PID Proportional Gain</i> . This parameter is available for the FC 302 only. |

This parameter cannot be adjusted while motor is running.

2.4.7. 1-7* Start Adjustments

Parameters for setting special motor start features.

| 1-71 Start Delay | |
|-----------------------|--|
| Range: | Function: |
| 0.0 s* [0.0 - 10.0 s] | This parameter refers to the start function selected in par. 1-72, <i>Start Function</i> . |

Enter the time delay required before commencing acceleration.

2

1-72 Start Function

Option:

Function:

Select the start function during start delay. This parameter is linked to par. 1-71 *Start Delay*.

| | | |
|-------|--|--|
| [0] | DC hold/ delay time | Energizes motor with a DC holding current (par. 2-00) during the start delay time. |
| [1] | DC Brake/delay time | Energizes motor with a DC braking current (par. 2-01) during the start delay time. |
| [2] * | Coast/delay time | Releases shaft coasted drive during the start delay time (inverter off). |
| [3] | Start speed/ current clockwise operation | Only possible with VVC+. Connect the function described in par. 1-74 <i>Start Speed (RPM)</i> and par. 1-76 <i>Start Current</i> in the start delay time. Regardless of the value applied by the reference signal, the output speed applies the setting of the start speed in par. 1-74 or par. 1-75 and the output current corresponds to the setting of the start current in par. 1-76, <i>Start Current</i> . This function is typically used in hoisting applications without counterweight, and especially in applications with a cone motor where the start is clockwise, followed by rotation in the reference direction. |
| [4] | Horizontal operation | Only possible with VVC+. For obtaining the function described in par. 1-74 and par. 1-76 during the start delay time. The motor rotates in the reference direction. If the reference signal equals zero (0), par. 1-74 <i>Start speed (RPM)</i> is ignored and the output speed equals zero (0). The output current corresponds to the setting of the start current in par. 1-76 <i>Start current</i> . |
| [5] | VVC ^{plus} / Flux clockwise | for the function described in par. 1-74 only (Start speed in the start delay time). The start current is calculated automatically. This function uses the start speed in the start delay time only. Regardless of the value set by the reference signal, the output speed equals the setting of the start speed in par. 1-74. Start speed/current clockwise [3] and VVCplus/Flux clockwise [5] are typically used in hoisting applications. <i>Start speed/current in reference direction</i> [4] is particularly used in applications with counterweight and horizontal movement. |
| [6] | Hoist Mech. Brake Rel | For utilizing mechanical brake control functions, par. 2-24 to 2-28. This parameter is only active when par. 1-01 is set to [3] <i>Flux w/ motor feedback (FC 302 only)</i> . |

1-73 Flying Start [RPM]

| | | |
|----------------|-----|---|
| Option: | | Function: |
| | | This function makes it possible to catch a motor that is spinning freely due to a line drop-out. |
| [0] * | Off | No function |
| [1] | On | Enables the adjustable frequency drive to “catch” and control a spinning motor. When par. 1-73 is enabled, par. 1-71 <i>Start Delay</i> and 1-72 <i>Start Function</i> have no function. |

This parameter cannot be adjusted while motor is running.



NOTE

This function is not recommended for hoisting applications.

1-74 Start Speed [rpm]

| | |
|----------------------|---|
| Range: | Function: |
| 0 rpm* [0 - 600 rpm] | Set the motor start speed. After the start signal, the motor output speed leaps to the set value. This parameter can be used for hoist applications (cone rotor motors). Set the start function in par. 1-72 <i>Start Function</i> to [3], [4] or [5], and set a start delay time in par. 1-71 <i>Start Delay</i> . A reference signal must be present. |

1-75 Start Speed [Hz]

| | |
|--------------------|---|
| Range: | Function: |
| 0 Hz* [0 - 500 Hz] | Set the motor start speed. After the start signal, the motor output speed leaps to the set value. This parameter can be used for hoist applications (cone rotor motors). Set the start function in par. 1-72 <i>Start Function</i> to [3], [4] or [5], and set a start delay time in par. 1-71 <i>Start Delay</i> . A reference signal must be present. |

1-76 Start Current

| | |
|----------------------------|--|
| Range: | Function: |
| 0.00 A* [0.00 - par. 1-24] | Some motors, such as cone rotor motors, need extra current/starting speed (boost) to disengage the mechanical brake. Adjust par. 1-74, <i>Start Speed [RPM]</i> , and par. 1-76 to get this boost. Set the required current value to disengage the mechanical brake. Set par. 1-72, <i>Start Function</i> to [3] or [4], and set a start delay time in par. 1-71, <i>Start Delay</i> . A reference signal must be present. |

2.4.8. 1-8* Stop Adjustments

Parameters for setting special stop features for the motor.

1-80 Function at Stop

Option:

Function:

Select the drive function after a stop command or after the speed is ramped down to the settings in par. 1-81, *Min Speed for Function at Stop [RPM]*.

| | | |
|-------|-----------------|--|
| [0] * | Coast | Leaves motor in free mode. |
| [1] | DC hold | Energizes motor with a DC holding current (see par. 2-00). |
| [2] | Motor check | Checks if a motor has been connected. |
| [3] | Pre-magnetizing | Builds up a magnetic field while the motor is stopped. The motor can now produce a quick torque build-up at start. |
| [4] | DC Voltage U0 | |

1-81 Min Speed for Function at Stop [RPM]

Range:

3 rpm* [0 - 600 rpm]

Function:

Set the speed at which to activate par. 1-80 *Function at stop*.

1-82 Min Speed for Function at Stop [Hz]

Range:

0.0 Hz* [0.0 - 500 Hz]

Function:

Set the output frequency at which to activate par. 1-80 *Function at stop*.

1-83 Precise Stop Function

Option:

Function:

| | | |
|-------|-----------------------------|---|
| [0] * | Precise ramp stop | Achieves high repetitive precision at the stopping point. |
| [1] | Counter stop with re-set | Runs the adjustable frequency drive from receipt of a pulse start signal until the number of pulses programmed by the user in par. 1-84 <i>Precise Stop Counter Value</i> has been received at input terminal 29 or input terminal 33. An internal stop signal will activate the normal ramp-down time (par. 3-42, 3-52, 3-62 or 3-72). The counter function is activated (starts timing) at the edge of the start signal (when it changes from stop to start). After each precise stop, the number of pulses counted during ramp-down 0 rpm is reset. |
| [2] | Counter stop without re-set | Same as [1], but the number of pulses counted during ramp-down to 0 rpm is deducted from the counter value in par. 1-84. |

| | | |
|-----|--------------------------------------|--|
| [3] | Speed compensated stop | Stops at precisely the same point, regardless of the present speed, the stop signal is delayed internally when the present speed is lower than the maximum speed (set in par. 4-19). |
| [4] | Speed compensated stop with re-set | Same as [3], but after each precise stop the number of pulses counted during ramp-down 0 rpm is reset. |
| [5] | Speed compensated stop without reset | Same as [3], but the number of pulses counted during ramp-down to 0 rpm is deducted from the counter value in par. 1-84. |

This parameter cannot be adjusted while the motor is running.

| 1-84 Precise Stop | |
|--|--|
| Range: 100000 [0 - 999999999] * | Function: Enter the counter value to be used in the integrated precise stop function, par. 1-83. The maximum permissible frequency at terminal 29 or 33 is 110 kHz. |

| 1-85 Precise Stop Speed Compensation Delay | |
|--|---|
| Range: 10 ms* [1-100 ms] | Function: Enter the delay time for sensors, PLCs, etc. to be used in par. 1-83 <i>Precise Stop Function</i> . In speed-compensated stop mode, the delay time at different frequencies has a major influence on the stop function. |

2.4.9. 1-9* Motor Temperature

Parameters for setting the temperature protection features for the motor.

| 1-90 Motor Thermal Protection | |
|-------------------------------|---|
| Option: | Function: The adjustable frequency drive determines the motor temperature for motor protection in two different ways: <ul style="list-style-type: none"> Via a thermistor sensor connected to one of the analog or digital inputs (par. 1-93 Thermistor Source). Via calculation (ETR = Electronic Terminal Relay) of the thermal load, based on the actual load and time. The calculated thermal load is compared with the rated motor current $I_{M,N}$ and the rated motor frequency $f_{M,N}$. The calculations estimate the need for a lower load at lower speed due to less cooling from the fan incorporated in the motor. |
| [0] * | No protection Continuously overloaded motor, when no warning or trip of drive is required. |

2

| | | |
|------|--------------------|--|
| [1] | Thermistor warning | Activates a warning when the connected thermistor or KTY sensor in the motor reacts in the event of motor overtemperature. |
| [2] | Thermistor trip | Stops (trips) adjustable frequency drive when connected thermistor in motor reacts in the event of motor overtemperature. The thermistor cut-out value must be > 3 k Ω . Integrate a thermistor (PTC sensor) in the motor for winding protection. |
| [3] | ETR warning 1 | |
| [4] | ETR trip 1 | |
| [5] | ETR warning 2 | |
| [6] | ETR trip 2 | |
| [7] | ETR warning 3 | |
| [8] | ETR trip 3 | |
| [9] | ETR warning 4 | |
| [10] | ETR trip 4 | |

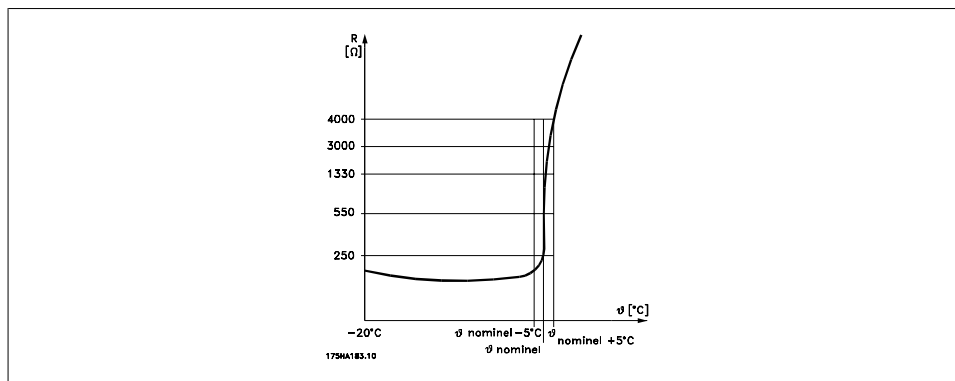

Motor protection can be implemented using a range of techniques: PTC or KTY sensor (see also section *KTY Sensor Connection*) in motor windings; mechanical thermal switch (Klixon type) or Electronic Thermal Relay (ETR).

When using a digital input and 24 V as power supply:

Example: The adjustable frequency drive trips when the motor temperature is too high.

Parameter set-up:

Set Par. 1-90 *Motor Thermal Protection* to *Thermistor Trip* [2]

Set Par. 1-93 *Thermistor Source* to *Digital Input* [6]

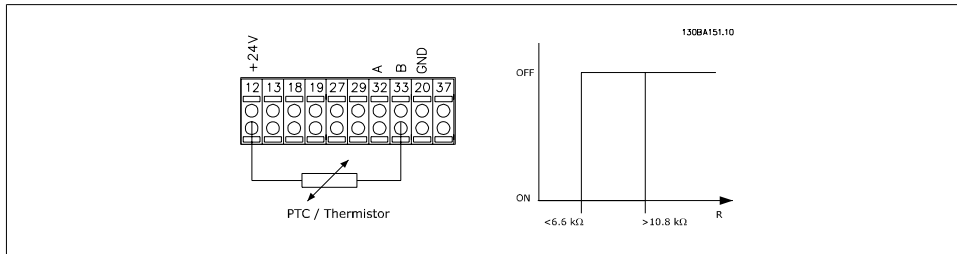

When using a digital input and 10 V as power supply:
 Example: The adjustable frequency drive trips when the motor temperature is too high.
 Parameter set-up:
 Set Par. 1-90 *Motor Thermal Protection* to *Thermistor Trip* [2]
 Set Par. 1-93 *Thermistor Source* to *Digital Input* [6]

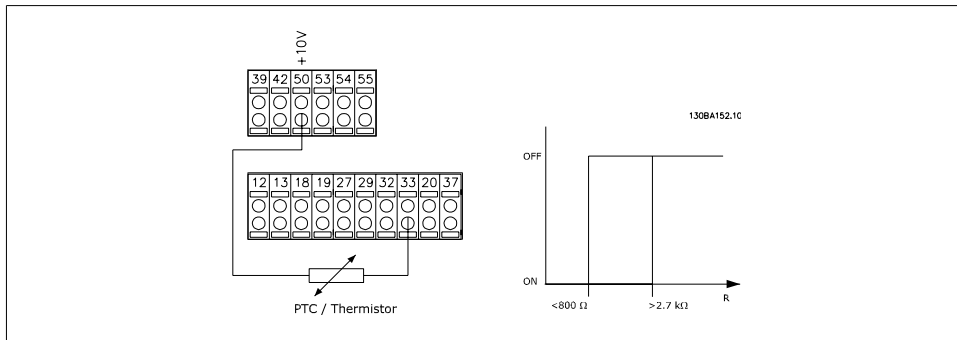

When using an analog input and 10 V as power supply:
 Example: The adjustable frequency drive trips when the motor temperature is too high.
 Parameter set-up:
 Set Par. 1-90 *Motor Thermal Protection* to *Thermistor Trip* [2]
 Set Par. 1-93 *Thermistor Source* to *Analog Input 54* [2]

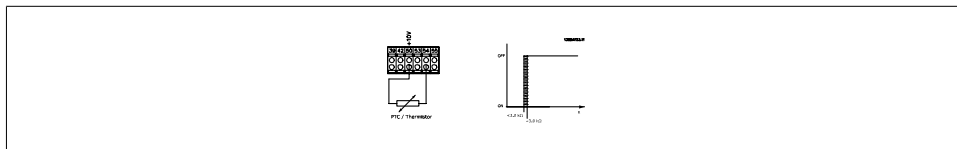

| Input | Supply Voltage | Threshold Cut-out Values |
|----------------|----------------|--------------------------|
| Digital/analog | Volt | |
| Digital | 24 V | < 6.6 kΩ - > 10.8 kΩ |
| Digital | 10 V | < 800Ω - > 2.7 kΩ |
| Analog | 10 V | < 3.0 kΩ - > 3.0 kΩ |

NOTE
 Ensure that the chosen supply voltage follows the specification of the thermistor element utilized.

2

Select *ETR Warning 1-4* to activate a warning on the display when the motor is overloaded.
 Select *ETR Trip 1-4* to trip the adjustable frequency drive when the motor is overloaded.
 Program a warning signal via one of the digital outputs. The signal appears in the event of a warning, or if the adjustable frequency drive trips (thermal warning).
 ETR (Electronic Terminal Relay) functions 1-4 will calculate the load when the set-up in which they were selected is active. For example, ETR starts calculating when set-up 3 is selected. For the North American market: The ETR functions provide class 20 motor overload protection in accordance with NEC.

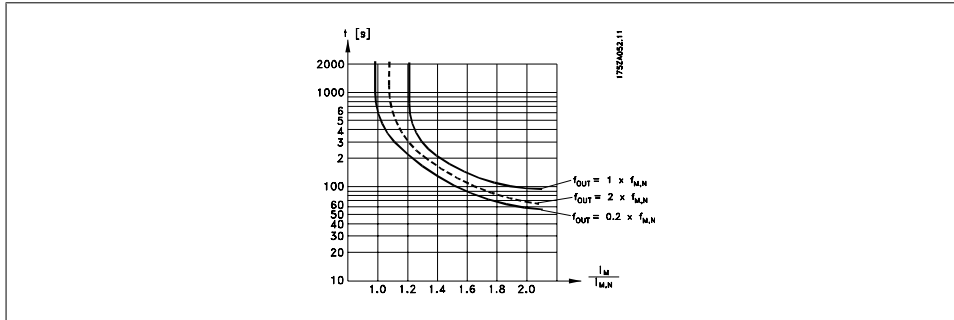

1-91 Motor External Fan

Option:

[0] * No

Function:

No external fan is required, i.e., the motor is derated at low speed.

[1] Yes

Applies an external motor fan (external ventilation), so that no derating of the motor is required at low speed. The graph below is followed if the motor current is lower than nominal motor current (see par. 1-24). If the motor current exceeds nominal current, the operation time still decreases as if no fan were installed.

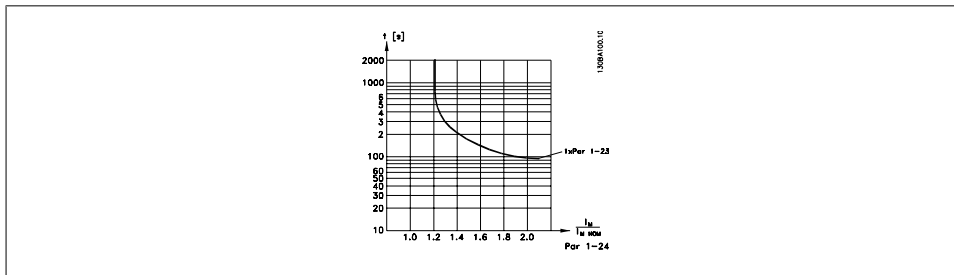

1-93 Thermistor Source

Option:

Function:

Select the input to which the thermistor (PTC sensor) should be connected. An analog input option [1] or [2] cannot be selected if the analog input is already in use as a reference source (se-

lected in par. 3-15 Reference Source 1, 3-16 Reference Source 2 or 3-17 Reference Source 3).

This parameter cannot be adjusted while the motor is running.

| | |
|-------|------------------|
| [0] * | None |
| [1] | Analog input 53 |
| [2] | Analog input 54 |
| [3] | Digital input 18 |
| [4] | Digital input 19 |
| [5] | Digital input 32 |
| [6] | Digital input 33 |

2.4.10. KTY Sensor Connection

FC 302 only)

KTY sensors are used especially in permanent magnet servo motors (PM motors) for the dynamic adjusting of motor parameters as stator resistance (par. 1-30) for PM motors, and also rotor resistance (par. 1-31) for asynchronous motors, depending on winding temperature. The calculation is:

$$R_s = R_{s_{20^{\circ}C}} \times (1 + \alpha_{cu} \times \Delta T) [\Omega] \text{ where } \alpha_{cu} = 0.00393$$

KTY sensors can be used for motor protecting (par 1-97).

The FC 302 can handle three types of KTY sensors, defined in par 1-95. The actual sensor temperature can be read out from par 16-19.

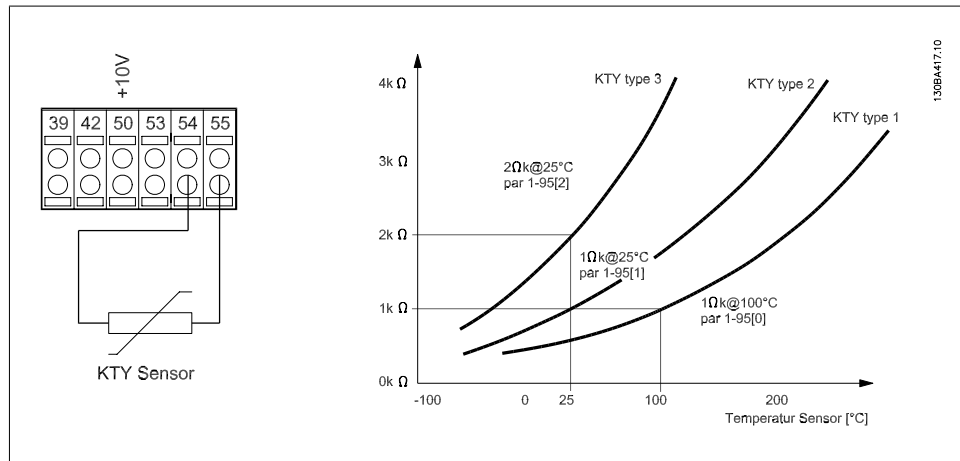

NOTE
 If the temperature of the motor is utilized through a thermistor or KTY sensor, the PELV is not complied with in case of short circuits between motor windings and sensor. In order to comply with PELV, the sensor must be extra isolated.

1-95 KTY Sensor Type

Option:
Function:

Select the used type of KTY sensor:

KTY Sensor type 1: 1 Kohm at 212 degrees F [100 degrees C]
 KTY Sensor type 2: 1 Kohm at 77 degrees F [25 degrees C]
 KTY Sensor type 3: 2 Kohm at 77 degrees F [25 degrees C]

This parameter only applies for the FC 302.

[0] * KTY Sensor 1

[1] KTY Sensor 2

[2] KTY Sensor 3

1-96 KTY Thermistor Source

Option:
Function:

Selecting analog input terminal 54 to be used as KTY sensor input. Terminal 54 cannot be selected as KTY source if otherwise used as reference (see par. 3-15 to 3-17).

This parameter only applies for FC 302.

NOTE

Connection of KTY sensor between term. 54 and 55 (GND). See picture in section *KTY Sensor Connection*.

[0] * None

[2] Analog input 54

1-97 KTY Threshold level

Range:

176° F [-40 - +284° F [-40 - [80° C] +140° C]]

Function:

Select the KTY sensor threshold level for motor thermal protection. *This parameter only applies for the FC 302.*

2.5. Parameters: Brakes

2.5.1. 2-** Brakes

Parameter group for setting brake features in the adjustable frequency drive.

2.5.2. 2-0* DC Brakes

Parameter group for configuring the DC brake and DC hold functions.

2-00 DC Hold Current

Range:

50 %* [0 - 160%]

Function:

Enter a value for holding current as a percentage of the rated motor current $I_{M,N}$ set in par. 1-24 Motor Current. 100% DC holding current corresponds to $I_{M,N}$.

This parameter holds the motor function (holding torque) or pre-heats the motor.

This parameter is active if *DC hold* is selected in par. 1-72, *Start Function* [0], or par. 1-80, *Function at Stop* [1].



NOTE

The maximum value depends on the rated motor current.

NOTE

Avoid 100% current for too long. It may damage the motor.

2-01 DC Brake Current

Range:

50%* [0 - 1000 %]

Function:

Enter a value for current as a percentage of the rated motor current $I_{M,N}$; see par. 1-24 *Motor Current*. 100% DC braking current corresponds to $I_{M,N}$.

DC brake current is applied on a stop command when: the speed is lower than the limit set in par. 2-03 *DC Brake-cut In Speed*; the DC Brake Inverse function is active; or via the serial communication port. The braking current is active during the time period set in par. 2-02 *DC Braking Time*.



NOTE

The maximum value depends on the rated motor current.

NOTE

Avoid 100% current for too long, as it may damage the motor.

2-02 DC Braking Time

Range:

10.0 s* [0.0 - 60.0 s]

Function:

Once activated, set the duration of the DC braking current set in par. 2-01.

2-03 DC Brake Cut-in Speed [rpm]

Range:

0 rpm* [0 - par. 4 -13]

Function:

Set the DC brake cut-in speed for activation of the DC braking current upon a stop command (set in par. 2-01).

2-04 DC Brake Cut-in Speed [Hz]

Option:[0 rpm]0 - par. 4 -14
***Function:**

Set the DC brake cut-in speed for activation of the DC braking current upon a stop command (set in par. 2-01).

2.5.3. 2-1* Brake Energy Funct.

Parameter group for selecting dynamic braking parameters.

2-10 Brake Function

Option:

[0] Off

Function:

No brake resistor is installed.

[1] Resistor brake

A brake resistor is incorporated in the system, for dissipating surplus brake energy as heat. Connecting a brake resistor allows a higher DC link voltage during braking (generating operation). The resistor brake function is only active in adjustable frequency drives with an integral dynamic brake.

[2] AC brake

2-11 Brake Resistor (ohm)

Range:Size re-[Ohm]
lated**Function:**

Set the brake resistor value in Ohms. This value is used for monitoring the power to the brake resistor in par. 2-13 *Braking Energy Monitoring*. This parameter is only active in adjustable frequency drives with an integral dynamic brake.

2-12 Braking Energy

Range:

kW* [0.001 - Size-related]

Function:

Set the monitoring limit of the braking energy transmitted to the resistor.

The monitoring limit is a product of the maximum duty cycle (120 sec.) and the maximum power of the brake resistor at that duty cycle. See the formula below.

| | |
|----------------------|---|
| For 200-240 V units: | $P_{resistor} = \frac{390^2 \times dutytime}{R \times 120}$ |
| For 380-480 V units | $P_{resistor} = \frac{778^2 \times dutytime}{R \times 120}$ |
| For 380-500 V units | $P_{resistor} = \frac{810^2 \times dutytime}{R \times 120}$ |
| For 575-600 V units | $P_{resistor} = \frac{943^2 \times dutytime}{R \times 120}$ |

This parameter is only active in drives with an integral dynamic brake.

2-13 Braking Energy Monitoring

Option:

Function:

This parameter is only active in adjustable frequency drives with an integral dynamic brake.

This parameter enables monitoring of the power to the brake resistor. The power is calculated on the basis of the resistance (par. 2-11 *Brake Resistor (Ohm)*), the DC link voltage and the resistor duty time.

| | | |
|-------|------------------|--|
| [0] * | Off | No braking energy monitoring required. |
| [1] | Warning | Activates a warning on the display when the power transmitted over 120 s exceeds 100% of the monitoring limit (par. 2-12 <i>Braking Energy Limit (kW)</i>). The warning disappears when the transmitted power falls below 80% of the monitoring limit. |
| [2] | Trip | Trips adjustable frequency drive and displays an alarm when the calculated power exceeds 100% of the monitoring limit. |
| [3] | Warning and Trip | Activates both of the above, including warning, trip and alarm. |

If power monitoring is set to *Off*[0] or *Warning*[1], the brake function remains active, even if the monitoring limit is exceeded. This may lead to thermal overload of the resistor. It is also possible to generate a warning via a relay/digital output. The measuring accuracy of the power monitoring depends on the accuracy of the resistance of the resistor (greater than ± 20%).

2-15 Brake Check

Option:

Function:

Select type of test and monitoring function to check the connection to the brake resistor, or whether a brake resistor is present, and then display a warning or an alarm in the event of a fault.

**NOTE**

The brake resistor disconnection function is tested during power-up. However, the brake IGBT test is performed when there is no braking. A warning or trip disconnects the brake function.

The testing sequence is as follows:

1. The DC link ripple amplitude is measured for 300 ms without braking.
2. The DC link ripple amplitude is measured for 300 ms with the brake turned on.
3. If the DC link ripple amplitude while braking is lower than the DC link ripple amplitude before braking + 1%: *Brake check failed, return a warning or alarm.*
4. If the DC link ripple amplitude while braking is higher than the DC link ripple amplitude before braking + 1%: *Brake check OK.*

| | | |
|-------|---------------|--|
| [0] * | Off | Monitors brake resistor and brake IGBT for a short-circuit during operation. If a short-circuit occurs, a warning appears. |
| [1] | Warning | Monitors brake resistor and brake IGBT for a short-circuit, and runs a test for brake resistor disconnection during power-up. |
| [2] | Trip | Monitors for a short-circuit or disconnection of the brake resistor, or a short-circuit of the brake IGBT. If a fault occurs, the drive cuts out while displaying an alarm (trip-locked). |
| [3] | Stop and Trip | Monitors for a short-circuit or disconnection of the brake resistor, or a short-circuit of the brake IGBT. If a fault occurs, the drive ramps down to coast and then trips. A trip lock alarm is displayed. |
| [4] | AC brake | Monitors for a short-circuit or disconnection of the brake resistor, or a short-circuit of the brake IGBT. If a fault occurs, the drive performs a controlled ramp-down. This option is only available for the FC 302. |

**NOTE**

NB!: Remove a warning arising in connection with *Off* [0] or *Warning* [1] by cycling the line supply. The fault must be corrected first. For *Off* [0] or *Warning* [1], the drive keeps running even if a fault is located.

This parameter is only active in drives with an integral dynamic brake.

2-16 AC Brake Max. Current

| | |
|------------------------------------|--|
| Range: 100%* [0 - 1000%] | Function: Enter the maximum permissible current when using AC brake to avoid overheating motor windings. The AC brake function is available in flux mode only (FC 302 only). |
|------------------------------------|--|

2-17 Overvoltage Control

| | |
|----------------|---|
| Option: | Function: Overvoltage control (OVC) reduces the risk of the drive tripping due to an overvoltage on the DC link caused by generative power from the load. |
|----------------|---|

| | | |
|-------|----------|------------------|
| [0] * | Disabled | No OVC required. |
|-------|----------|------------------|

| | | |
|-----|-----------------------|---|
| [1] | Enabled (not at stop) | Activates OVC except when using a stop signal to stop the adjustable frequency drive. |
|-----|-----------------------|---|

| | | |
|-----|---------|----------------|
| [2] | Enabled | Activates OVC. |
|-----|---------|----------------|

| | |
|---|--|
|  | <p>NOTE OVC must not be enabled in hoisting applications.</p> |
|---|--|

2.5.4. 2-2* Mechanical Brake

Parameters for controlling operation of an electro-magnetic (mechanical) brake, typically required in hoisting applications.

To control a mechanical brake, a relay output (relay 01 or relay 02) or a programmed digital output (terminal 27 or 29) is required. Normally this output must be closed during periods when the drive is unable to 'hold' the motor, such as when loads are excessive, for example. Select *Mechanical Brake Control* [32] for applications with an electro-magnetic brake in par. 5-40 *Function Relay*, par. 5-30 *Terminal 27 Digital Output*, or par. 5-31 *Terminal 29 Digital Output*. When selecting *Mechanical brake control*[32], the mechanical brake is closed from start up until the output current is above the level selected in par. 2-20 *Release Brake Current*. During stop, the mechanical brake activates when the speed falls below the level specified in par. 2-21 *Activate Brake Speed [RPM]*. If the adjustable frequency drive enters an alarm condition or an overcurrent or overvoltage situation, the mechanical brake immediately cuts in. This is also the case during safe stop.

| | |
|---|---|
|  | <p>NOTE Protection mode and trip delay features (par. 14-25 and 14-26) may delay the activation of the mechanical brake in an alarm condition. These features must be disabled in hoisting applications.</p> |
|---|---|

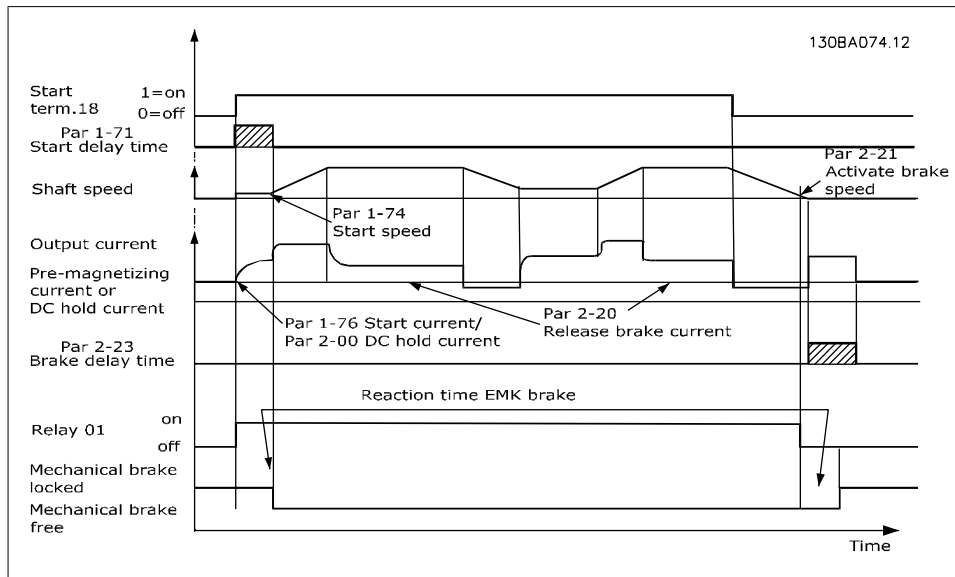

2-20 Release Brake Current

Range:

0.00 A* [0.00 - par. 16-37]

Function:

Set the motor current for release of the mechanical brake when a start condition is present. The upper limit is specified in par. 16-37 *Inv. Max. Current*.

2-21 Activate Brake Speed [rpm]

Range:

0 rpm* [0 - 60.000]

Function:

Set the motor speed for activation of the mechanical brake when a stop condition is present. The upper speed limit is specified in par. 4-53 *Warning Speed High*.

2-22 Activate Brake Speed [Hz]

Range:

0 Hz* [0 - 5000]

Function:

Set the motor frequency for activation of the mechanical brake when a stop condition is present.

2-23 Activate Brake Delay

Range:

0.0 s* [0.0 - 5.0 s]

Function:

Enter the brake delay time of the coast after ramp-down time. The shaft is held at zero speed with full holding torque. Ensure that the mechanical brake has locked the load before the motor enters coast mode. See *Mechanical Brake Control* section in the Design Guide.

2-24 Stop delay**Range:**

0.0 s* [0.0 - 5.0 s]

Function:

Set the time interval from the moment when the motor is stopped until the brake closes. This parameter is a part of the stopping function.

2-25 Brake Release Time**Range:**

0.20 s* [0.00 - 5.00 s]

Function:

This value defines the time it takes for the mechanical brake to open/close. This parameter must act as a timeout when brake feedback is activated.

2-26 Torque Ref**Range:**

0.00%* [-100.00 - 100.00 %]

Function:

The value defines the torque applied against the closed mechanical brake before release

2-27 Torque Ramp Time**Range:**

0.2 s* [0.0 - 5.0 s]

Function:

The value defines the duration of the torque ramp in clockwise direction.

2-28 Gain Boost Factor**Range:**

1.00* [0.00 - 4.00]

Function:

When a speed PID control is connected to the output (flux closed-loop), it must be possible to boost the proportional gain of the control during the *Activate Brake Delay* (par. 2-23). By increasing the gain, the bump when the motor takes over the load from the brake can be reduced. The risk of oscillation is very small due to the relatively short duration and the low (zero) speed.

2

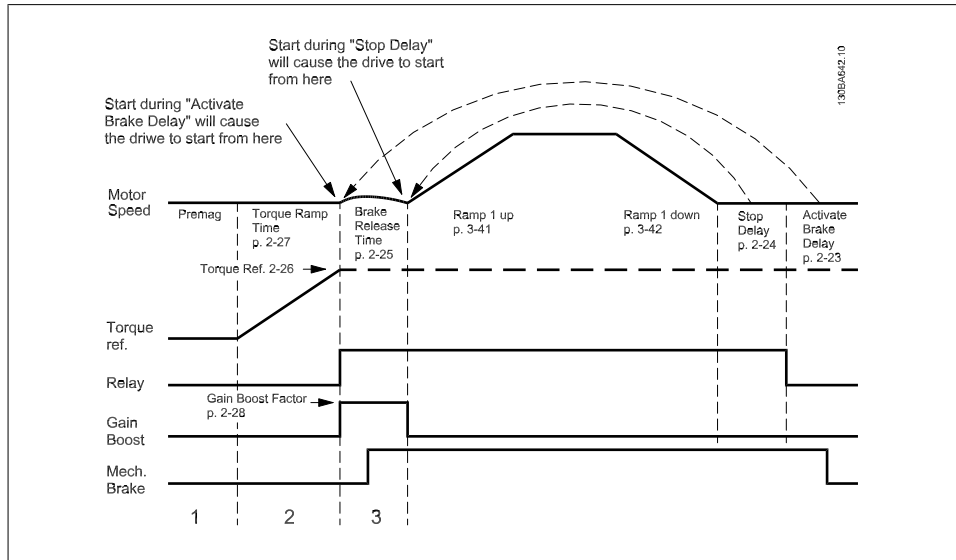

2.4: Brake release sequence for hoist mechanical brake control

2.6. Parameters: Reference/Ramps

2.6.1. 3-** Reference/Reference Limits/Ramps

Parameters for reference handling, defining limitations and configuring the reaction of the adjustable frequency drive to changes.

2.6.2. 3-0* Reference Limits

Parameters for setting the reference unit, limits and ranges.

3-00 Reference Range

Option:

Function:

Select the range of the reference signal and the feedback signal. Signal values can be positive only, or positive and negative. The minimum limit may have a negative value, unless *Speed closed-loop* [1] control or *Process* [3] is selected in par. 1-00 *Configuration Mode*.

| | | |
|-----|-------------|--|
| [0] | Min. - Max | For positive values only. |
| [1] | -Max - +Max | For both positive and negative values. |

3-05 Reference/Feedback Unit

Option:

Function:

Select the unit to be used in process PID control references and feedback.

| | |
|-------|---------------------|
| [0] | None |
| [1] | % |
| [2] * | rpm |
| [3] | Hz |
| [4] | Nm |
| [5] | PPM |
| [10] | 1/min |
| [12] | Pulse/s |
| [20] | I/s |
| [21] | I/min |
| [22] | I/h |
| [23] | m ³ /s |
| [24] | m ³ /min |
| [25] | m ³ /h |
| [30] | kg/s |
| [31] | kg/min |
| [32] | kg/h |

| | |
|-------|-----------------------|
| [33] | t/min |
| [34] | t/h |
| [40] | m/s |
| [41] | m/min |
| [45] | m |
| [60] | ° C |
| [70] | Mbar |
| [71] | Bar |
| [72] | Pa |
| [73] | kPa |
| [74] | m WG |
| [80] | kW |
| [120] | GPM |
| [121] | gal/s |
| [122] | gal/min |
| [123] | gal/h |
| [124] | CFM |
| [125] | ft ³ /sec. |
| [126] | ft ³ /min |
| [127] | ft ³ /h |
| [130] | Ib/s |
| [131] | Ib/min |
| [132] | Ib/h |
| [140] | ft/s |
| [141] | ft/min |
| [145] | ft |
| [150] | Ib ft |
| [160] | ° F |
| [170] | psi |
| [171] | Ib/in ² |
| [172] | in WG |
| [173] | ft WG |
| [180] | HP |

3-02 Minimum Reference

Range:

0.000 * [-100000.000 – par.
3-03]

Function:

Enter the Minimum Reference. The Minimum Reference is the lowest value obtainable by adding all references together. Minimum reference is active only when par. 3-00 *Reference Range* is set to *Min.- Max.* [0].
The minimum reference unit matches:

- The choice of configuration in par 1-00 *Configuration Mode*: for *Speed closed-loop* [1], RPM; for *Torque* [2], Nm.
- The unit selected in par. 3-01 *Reference/Feedback Unit*.

3-03 Maximum Reference

Range:

1500.00 [Par. 3-02
0* 100000.000]

Function:

- Enter the maximum reference. The maximum reference is the highest value obtainable by adding all references together.

The Maximum Reference unit matches:

- The choice of configuration in par. 1-00 *Configuration Mode*: for *Speed closed-loop* [1], RPM; for *Torque* [2], Nm.
- The unit selected in par. 3-01 *Reference/Feedback Unit*.

3-04 Reference Function

Option:

[0] * Sum

[1] External/Preset

Function:

Sums both external and preset reference sources.

Use either the preset or the external reference source.

Shift between external and preset via a command on a digital input.

2.6.3. 3-1* References

Parameters for setting up the reference sources.

Select the preset reference(s). *Select Preset ref. bit 0 / 1 / 2* [16], [17] or [18] for the corresponding digital inputs in parameter group 5.1* *Digital Inputs*.

3-10 Preset Reference

Array [8]
Range: 0-7

0.00%* [-100.00 - 100.00 %] Enter up to eight different preset references (0-7) in this parameter using array programming. The preset reference is stated as a percentage of the value Ref_{MAX} (par. 3-03 *Maximum Reference*). If a Ref_{MIN} different from 0 (par. 3-02 *Minimum Reference*) is programmed, the preset reference is calculated as a percentage of the full reference range, i.e., on the basis of the difference between Ref_{MAX} and Ref_{MIN}. Afterwards, the value is added to Ref_{MIN}. When using preset references, select Preset ref. bit 0 / 1 / 2 [16], [17] or [18] for the corresponding digital inputs in parameter group 5.1* *Digital Inputs*.

2

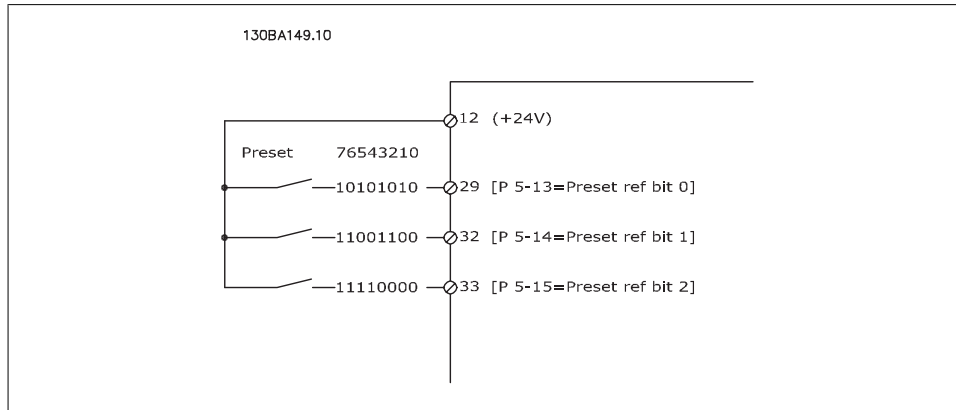

| Preset ref. bit | 2 | 1 | 0 |
|-----------------|---|---|---|
| Preset ref. 0 | 0 | 0 | 0 |
| Preset ref. 1 | 0 | 0 | 1 |
| Preset ref. 2 | 0 | 1 | 0 |
| Preset ref. 3 | 0 | 1 | 1 |
| Preset ref. 4 | 1 | 0 | 0 |
| Preset ref. 5 | 1 | 0 | 1 |
| Preset ref. 6 | 1 | 1 | 0 |
| Preset ref. 7 | 1 | 1 | 1 |

3-11 Jog Speed

Range:

Size-re- [0.0 - par. 4-14]
lated

Function:

The jog speed is a fixed output speed at which the adjustable frequency drive is running when the jog function is activated. See also par. 3-80.

3-12 Catch up/slow-down value

Range:

0.00% [0.00 - 100.00%]

Function:

Enter a percentage (relative) value to be either added or deducted from the actual reference for catch up or slow-down, respectively. If *Catch up* is selected via one of the digital inputs (par. 5-10 to par. 5-15), the percentage (relative) value is added to the total reference. If *Slow down* is selected via one of the digital inputs (par. 5-10 to par. 5-15), the percentage (relative) value is deducted from the total reference. Obtain extended functionality with the DigiPot function. See parameter group 3-9* *Digital Potentiometer*.

3-13 Reference Site

Option:

[0] * Linked to Hand/Auto

Function:

Select which reference site to activate.

Use local reference when in hand mode; or remote reference when in auto mode.

- [1] Remote Use remote reference in both hand mode and auto mode.
- [2] Local Use local reference in both hand mode and auto mode.

3-14 Preset Relative Reference

Range: 0.00%* [-200.00 - 200.00 %]
Function: The actual reference X is increased or decreased with the percentage Y, set in par.3-14. This results in the actual reference Z. Actual reference (X) is the sum of the inputs selected in par. 3-15, Reference Source 1, par.3-16, Reference Source 2, par. 3-17, Reference Source 3, and par.8-02, Control Word Source.

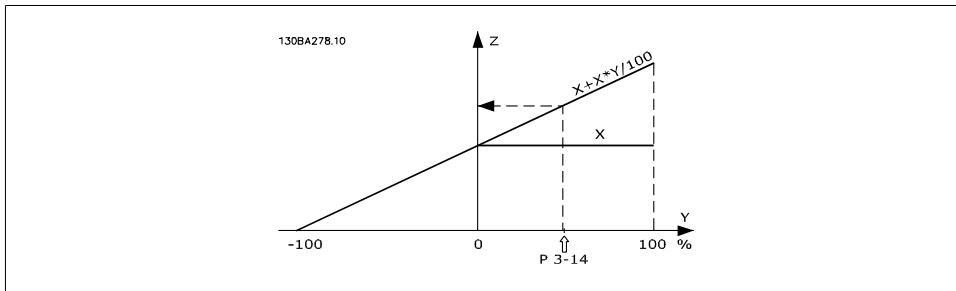
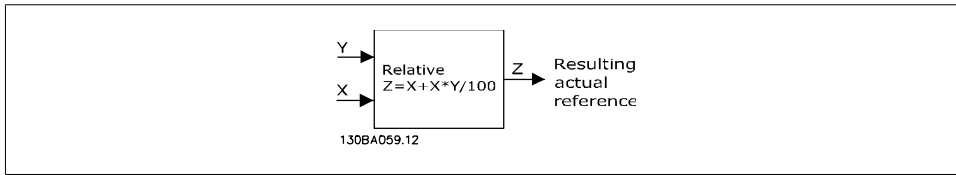

3-15 Reference Source 1

Option:
Function: Select the reference input to be used for the first reference signal. Par. 3-15, 3-16 and 3-17 define up to three different reference signals. The sum of these reference signals defines the actual reference.

- [0] No function
- [1] * Analog input 53
- [2] Analog input 54
- [7] Frequency input 29 (FC 302 only)
- [8] Frequency input 33
- [11] Local bus reference
- [20] Digital potentiometer
- [21] Analog input X30-11
- [22] Analog input X30-12

3-16 Reference Source 2

Option:
Function:

Select the reference input to be used for the second reference signal. Par. 3-15, 3-16 and 3-17 define up to three different reference signals. The sum of these reference signals defines the actual reference.

| | |
|--------|-------------------------------------|
| [0] | No function |
| [1] | Analog input 53 |
| [2] | Analog input 54 |
| [7] | Frequency input 29 (FC 302 only) |
| [8] | Frequency input 33 |
| [11] | Local bus reference |
| [20] * | Digital potentiometer |
| [21] | Analog input X30-11 |
| [22] | Analog input X30-12 |

3-17 Reference Source 3

Option:
Function:

Select the reference input to be used for the third reference signal. Par. 3-15, 3-16 and 3-17 define up to three different reference signals. The sum of these reference signals defines the actual reference.

| | |
|--------|-------------------------------------|
| [0] | No function |
| [1] | Analog input 53 |
| [2] | Analog input 54 |
| [7] | Frequency input 29 (FC 302 only) |
| [8] | Frequency input 33 |
| [11] * | Local bus reference |
| [20] | Digital potentiometer |
| [21] | Analog input X30-11 |
| [22] | Analog input X30-12 |

3-18 Relative Scaling Reference Source

Option:
Function:

Select a variable value to be added to the fixed value (defined in par. 3-14, *Preset Relative Reference*). The sum of the fixed and variable values (labeled Y in the illustration below) is multiplied by the actual reference (labeled X in the illustration below). The result is then added to the actual reference ($X + X*Y/100$) to give the resulting actual reference.

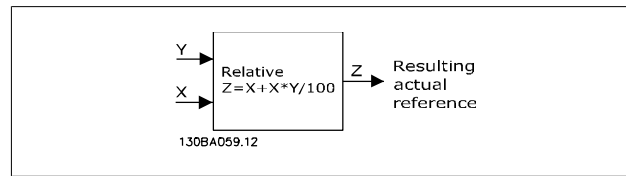

This parameter cannot be adjusted while the motor is running.

| | |
|-------|-------------------------------------|
| [0] * | No function |
| [1] | Analog input 53 |
| [2] | Analog input 54 |
| [7] | Frequency input 29 (FC 302 only) |
| [8] | Frequency input 33 |
| [11] | Local bus reference |
| [20] | Digital potentiometer |
| [21] | Analog input X30-11 |
| [22] | Analog input X30-12 |

3-19 Jog Speed

Range:

150 [0 - par. 4-13 rpm]
rpm*

Function:

Enter a value for the jog speed n_{JOG} , which is a fixed output speed. The adjustable frequency drive runs at this speed when the jog function is activated. The maximum limit is defined in par. 4-13 *Motor Speed High Limit (RPM)*.
See also par. 3-80.

2.6.4. Ramps

3-4* Ramp 1

For each of the four ramps (par. 3-4*, 3-5*, 3-6* and 3-7*), configure the ramp parameters: ramp type, ramping times (duration of acceleration and deceleration) and level of jerk compensation for S ramps.

Start by setting the linear ramping times corresponding to the figures.

2

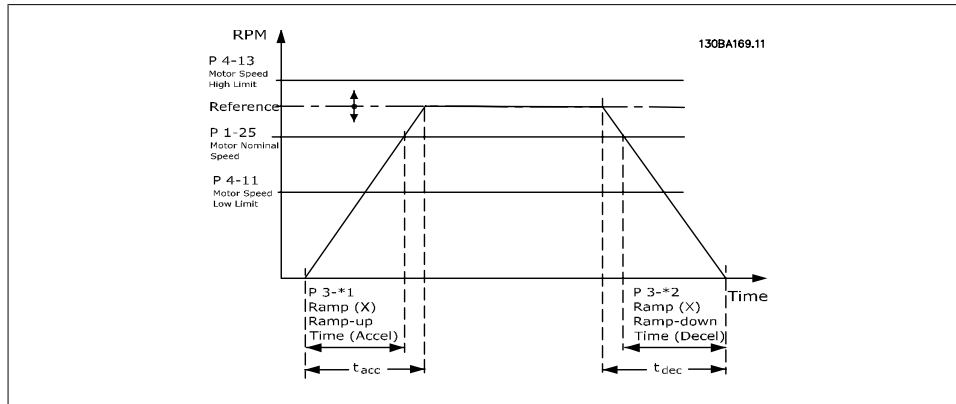

If S-ramps are selected, then set the level of non-linear jerk compensation required. Set jerk compensation by defining the proportion of ramp-up and ramp-down times where acceleration and deceleration are variable (i.e., increasing or decreasing). The S-ramp acceleration and deceleration settings are defined as a percentage of the actual ramp time.

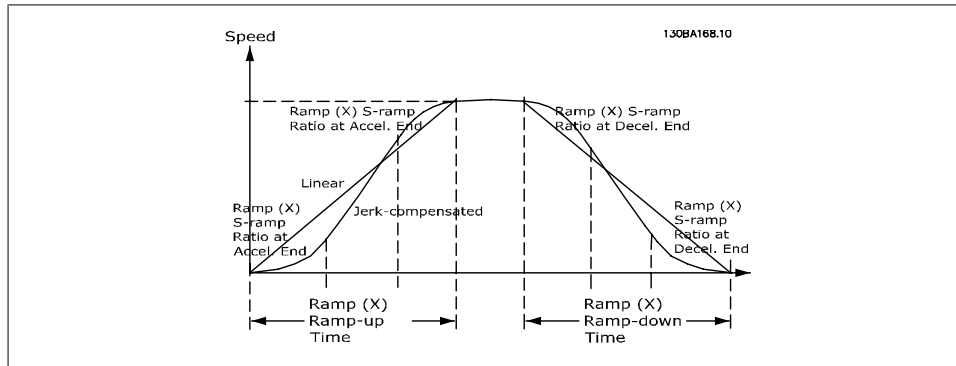

3-40 Ramp 1 Type

Option:

Function:

Select the ramp type, depending on requirements for acceleration/deceleration. A linear ramp will give constant acceleration during ramping. An S-ramp will give non-linear acceleration, compensating for jerk in the application.

| | | |
|-------|-------------------|---|
| [0] * | Linear | |
| [1] | S-ramp Const Jerk | Acceleration with lowest possible jerk. |
| [2] | S-ramp Const Time | S-ramp based on the values set in par. 3-41 and 3-42. |



NOTE

If S-ramp [1] is selected and the reference during ramping is changed, the ramp time may be prolonged in order to realize a jerk-free movement, which may result in a longer start or stop time. Additional adjustment of the S-ramp ratios or switching initiators may be necessary.

3-41 Ramp 1 Ramp-up Time

Range:
Size-re- [0.01 - 3,600.00 s]
lated

Function:
Enter the ramp-up time, i.e., the acceleration time from 0 rpm to the rated motor speed $n_{M,N}$ (par. 1-25). Choose a ramp-up time such that the output current does not exceed the current limit in par. 4-18 during ramping. The value 0.00 corresponds to 0.01 sec. in speed mode. See ramp-down time in par. 3-42.

$$Par. 3 - 41 = \frac{t_{acc} [s] \times n_{M, N} (par. 1 - 25) [rpm]}{\Delta ref [rpm]}$$

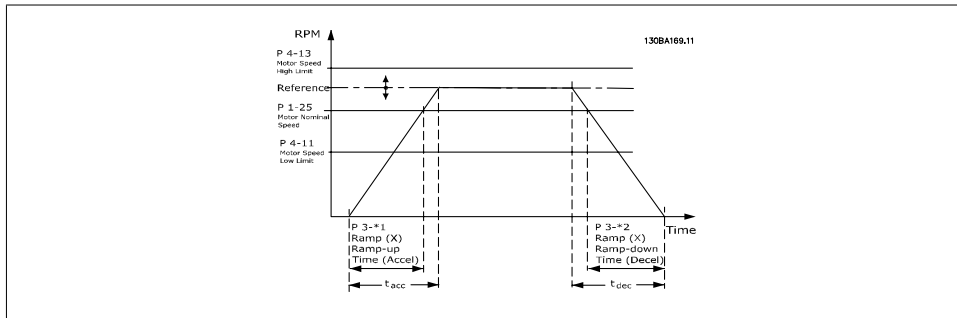

3-42 Ramp 1 Ramp-down Time

Range:
Size re-[0.01 - 3600.00 s]
lated

Function:
Enter the ramp-down time, i.e., the deceleration time from the rated motor speed $n_{M,N}$ (par. 1-25) to 0 RPM. Choose a ramp-down time so that no overvoltage arises in the inverter due to regenerative operation of the motor, and so that the generated current does not exceed the current limit set in par. 4-18. The value 0.00 corresponds to 0.01 s in speed mode. See ramp-up time in par. 3-41.

$$Par. 3 - 42 = \frac{t_{dec} [s] \times n_{M, N} (par. 1 - 25) [RPM]}{\Delta ref [RPM]}$$

3-45 Ramp 1 S-ramp Ratio at Accel. Start

Range:
50%* [1 - 99%]

Function:
Enter the proportion of the total ramp-up time (par. 3-41) during which the acceleration torque increases. The larger the percentage value, the greater the jerk compensation achieved, and thus the lower the torque jerks that occur in the application.

3-46 Ramp 1 S-ramp Ratio at Accel. End

Range:
50%* [1 - 99%]

Function:
Enter the proportion of the total ramp-up time (par. 3-41) during which the acceleration torque decreases. The larger the percentage value, the greater the jerk compensation achieved, and thus the lower the torque jerks that occur in the application.

3-47 Ramp 1 S-ramp Ratio at Decel. Start

Range:

50%* [1 - 99%]

Function:

Enter the proportion of the total ramp-down time (par. 3-42) during which the deceleration torque increases. The larger the percentage value, the greater the jerk compensation achieved, and thus the lower the torque jerks that occur in the application.

3-48 Ramp 1 S-ramp Ratio at Decel. End

Range:

50%* [1 - 99%]

Function:

Enter the proportion of the total ramp-down time (par. 3-42) during which the deceleration torque decreases. The larger the percentage value, the greater the jerk compensation achieved, and thus the lower the torque jerks that occur in the application.

2.6.5. 3-5* Ramp 2

Choosing ramp parameters, see 3-4*.

3-50 Ramp 2 Type

Option:**Function:**

Select the ramp type, depending on requirements for acceleration/deceleration. A linear ramp will give constant acceleration during ramping. An S-ramp will give non-linear acceleration, compensating for jerk in the application.

[0] * Linear

[1] S-ramp Const Jerk Acceleration with lowest possible jerk

[2] S-ramp Const Time S-ramp based on the values set in par. 3-51 and 3-52

**NOTE**

If S-ramp [1] is selected and the reference during ramping is changed, the ramp time may be prolonged in order to realize a jerk-free movement, which may result in a longer start or stop time.

Additional adjustment of the S-ramp ratios or switching initiators may be necessary.

3-51 Ramp 2 Ramp-up Time

Range:Size-re- [0.01 - 3,600.00 s]
lated**Function:**

Enter the ramp-up time, i.e., the acceleration time from 0 rpm to the rated motor speed $n_{M,N}$ (par. 1-25). Choose a ramp-up time such that the output current does not exceed the current limit in par. 4-18 during ramping. The value 0.00 corresponds to 0.01 sec. in speed mode. See ramp-down time in par. 3-52.

$$Par. 3 - 51 = \frac{t_{acc} [s] \times n_{M, N} (par. 1 - 25) [rpm]}{\Delta ref [rpm]}$$

3-52 Ramp 2 Ramp-down Time

Range:

Size re- [0.01 - 3600.00 s.]
lated

Function:

Enter the ramp-down time, i.e., the deceleration time from the rated motor speed $n_{M,N}$ (par. 1-25) to 0 RPM. Choose a ramp-down time so that no overvoltage arises in the inverter due to regenerative operation of the motor, and so that the generated current does not exceed the current limit set in par. 4-18. The value 0.00 corresponds to 0.01 s in speed mode. See ramp-up time in par. 3-51.

$$Par. 3 - 52 = \frac{t_{dec} [s] \times n_{M, N} (par. 1 - 25) [RPM]}{\Delta_{ref} [RPM]}$$

3-55 Ramp 2 S-ramp Ratio at Accel. Start

Range:

50%* [1 - 99%]

Function:

Enter the proportion of the total ramp-up time (par. 3-51) in which the acceleration torque increases. The larger the percentage value, the greater the jerk compensation achieved, and thus the lower the torque jerks in the application.

3-56 Ramp 2 S-ramp Ratio at Accel. End

Range:

50%* [1 - 99%]

Function:

Enter the proportion of the total ramp-up time (par. 3-51) in which the acceleration torque decreases. The larger the percentage value, the greater the jerk compensation achieved, and thus the lower the torque jerks in the application.

3-57 Ramp 2 S-ramp Ratio at Decel. Start

Range:

50%* [1 - 99%]

Function:

Enter the proportion of the total ramp-down time (par. 3-52) where the deceleration torque increases. The larger the percentage value, the greater the jerk compensation achieved, and thus the lower the torque jerks in the application.

3-58 Ramp 2 S-ramp Ratio at Decel. End

Range:

50%* [1 - 99%]

Function:

Enter the proportion of the total ramp-down time (par. 3-52) where the deceleration torque decreases. The larger the percentage value, the greater the jerk compensation achieved, and thus the lower the torque jerks in the application.

2.6.6. 3-6* Ramp 3

Configure ramp parameters, see 3-4*.

3-60 Ramp 3 Type

Option:
Function:

Select the ramp type, depending on requirements for acceleration and deceleration. A linear ramp will give constant acceleration during ramping. An S-ramp will give non-linear acceleration, compensating for jerk in the application.

[0] * Linear

[1] S-ramp Const Jerk Accelerates with lowest possible jerk.

[2] S-ramp Const Time S-ramp based on the values set in par. 3-61 and 3-62.

NOTE

If S-ramp [1] is selected and the reference during ramping is changed, the ramp time may be prolonged in order to realize a jerk-free movement, which may result in a longer start or stop time.

Additional adjustment of the S-ramp ratios or switching initiators may be necessary.

3-61 Ramp 3 Ramp-up Time

Range:

Size re- [0.01 - 3600.00 s]
lated

Function:

Enter the ramp-up time, i.e., the acceleration time from 0 RPM to the rated motor speed $n_{M,N}$ (par. 1-25). Choose a ramp-up time such that the output current does not exceed the current limit in par. 4-18 during ramping. The value 0.00 corresponds to 0.01 sec. in speed mode. See ramp-down time in par. 3-62.

3-62 Ramp 3 Ramp-down Time

Range:

Size re- [0.01 - 3600.00 s]
lated

Function:

Enter the ramp-down time, i.e., the deceleration time from the rated motor speed $n_{M,N}$ (par. 1-25) to 0 RPM. Choose a ramp-down time so that no overvoltage arises in the inverter due to regenerative operation of the motor, and so that the generated current does not exceed the current limit set in par. 4-18. The value 0.00 corresponds to 0.01 s in speed mode. See ramp-up time in par. 3-61.

$$Par. 3 - 62 = \frac{t_{dec} [s] \times n_{M, N} (par. 1 - 25) [RPM]}{\Delta ref [RPM]}$$

3-65 Ramp 3 S-ramp Ratio at Accel. Start

Range:

50%* [1 - 99%]

Function:

Enter the proportion of the total ramp-up time (par. 3-61) in which the acceleration torque increases. The larger the percentage value, the greater the jerk compensation achieved, and thus the lower the torque jerks in the application.

3-66 Ramp 3 S-ramp Ratio at Accel. End

Range:
50%* [1 - 99%]

Function:
Enter the proportion of the total ramp-up time (par. 3-61) in which the acceleration torque decreases. The larger the percentage value, the greater the jerk compensation achieved, and thus the lower the torque jerks in the application.

3-67 Ramp 3 S-ramp Ratio at Decel. Start

Range:
50%* [1 - 99%]

Function:
Enter the proportion of the total ramp-down time (par. 3-62) where the deceleration torque increases. The larger the percentage value, the greater the jerk compensation achieved, and thus the lower the torque jerks in the application.

3-68 Ramp 3 S-ramp Ratio at Decel. End

Range:
50%* [1 - 99%]

Function:
Enter the proportion of the total ramp-down time (par. 3-62) where the deceleration torque decreases. The larger the percentage value, the greater the jerk compensation achieved, and thus the lower the torque jerks in the application.

2.6.7. 3-7* Ramp 4

Configure ramp parameters, see 3-4*.

3-70 Ramp 4 Type

Option:
Function:
Select the ramp type, depending on requirements for acceleration and deceleration. A linear ramp will give constant acceleration during ramping. An S-ramp will give non-linear acceleration, compensating for jerk in the application.

- [0] * Linear
- [1] S-ramp Const Jerk Accelerates with lowest possible jerk.
- [2] S-ramp Const Time S-ramp based on the values set in par. 3-71 and 3-72.

NOTE
If S-ramp [1] is selected and the reference during ramping is changed, the ramp time may be prolonged in order to realize a jerk-free movement, which may result in a longer start or stop time.
Additional adjustment of the S-ramp ratios or switching initiators may be necessary.

3-71 Ramp 4 Ramp-up Time

Range:

Size re- [0.01 - 3600.00 s]
lated

Function:

Enter the ramp-up time, i.e., the acceleration time from 0 RPM to the rated motor speed $n_{M,N}$ (par. 1-25). Choose a ramp-up time such that the output current does not exceed the current limit in par. 4-18 during ramping. The value 0.00 corresponds to 0.01 sec. in speed mode. See ramp-down time in par. 3-72.

$$Par. 3 - 71 = \frac{t_{acc} [s] \times n_{M, N} (par. 1 - 25) [RPM]}{\Delta_{ref} [RPM]}$$

3-72 Ramp 4 Ramp-down Time

Range:

Size re- [0.01 - 3600.00 s]
lated

Function:

Enter the ramp-down time, i.e., the deceleration time from the rated motor speed $n_{M,N}$ (par. 1-25) to 0 RPM. Choose a ramp-down time so that no overvoltage arises in the inverter due to regenerative operation of the motor, and so that the generated current does not exceed the current limit set in par. 4-18. The value 0.00 corresponds to 0.01 s in speed mode. See ramp-up time in par. 3-71.

$$Par. 3 - 72 = \frac{t_{dec} [s] \times n_{M, N} (par. 1 - 25) [RPM]}{\Delta_{ref} [RPM]}$$

3-75 Ramp 4 S-ramp Ratio at Accel. Start

Range:

50%* [1 - 99%]

Function:

Enter the proportion of the total ramp-up time (par. 3-71) in which the acceleration torque increases. The larger the percentage value, the greater the jerk compensation achieved, and thus the lower the torque jerks in the application.

3-76 Ramp 4 S-ramp Ratio at Accel. End

Range:

50%* [1 - 99%]

Function:

Enter the proportion of the total ramp-up time (par. 3-71) in which the acceleration torque decreases. The larger the percentage value, the greater the jerk compensation achieved, and thus the lower the torque jerks in the application.

3-77 Ramp 4 S-ramp Ratio at Decel. Start

Range:

50%* [1 - 99%]

Function:

Enter the proportion of the total ramp-down time (par. 3-72) where the deceleration torque increases. The larger the percentage value, the greater the jerk compensation achieved, and thus the lower the torque jerks in the application.

3-78 Ramp 4 S-ramp Ratio at Decel. End

Range:
50%* [1 - 99%]

Function:
Enter the proportion of the total ramp-down time (par. 3-72) where the deceleration torque decreases. The larger the percentage value, the greater the jerk compensation achieved, and thus the lower the torque jerks in the application.

2.6.8. 3-8* Other Ramps

Configure parameters for special ramps such as jog or quick stop, for example.

3-80 Jog Ramp Time

Range:
Size re- [0.01 - 3600.00 s]
lated

Function:
Enter the jog ramp time, i.e., the acceleration/deceleration time between 0 RPM and the rated motor frequency $n_{M,N}$ (set in par. 1-25 *Motor Nominal Speed*). Ensure that the resulting output current required for the given jog ramp time does not exceed the current limit in par. 4-18. The jog ramp time starts upon activation of a jog signal via the control panel, a selected digital input or the serial communication port.

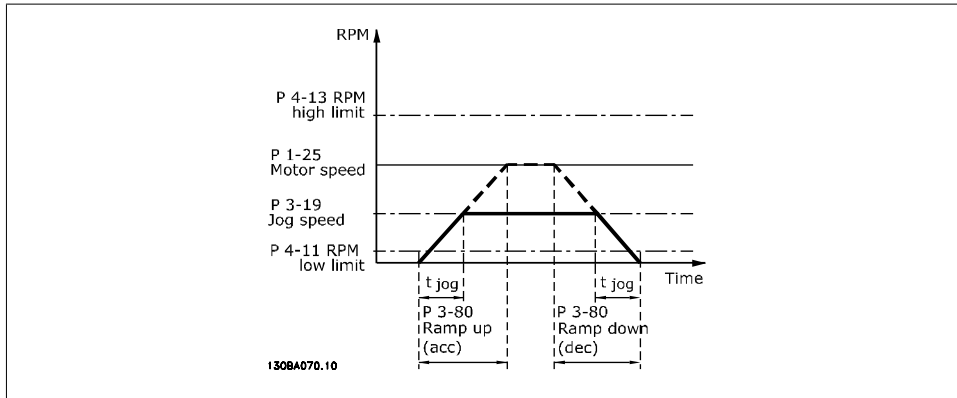

$$Par. 3 - 80 = \frac{t_{jog} [s] \times n_{M, N} (par. 1 - 25) [RPM]}{\Delta \log speed (par. 3 - 19) [RPM]}$$

3-81 Quick Stop Ramp Time

Range:
3 s* [0.01 - 3600.00 s]

Function:
Enter the quick stop ramp-down time, i.e., the deceleration time from the rated motor speed to 0 RPM. Ensure that no resultant overvoltage will arise in the inverter due to regenerative operation of the motor required to achieve the given ramp-down time. Also ensure that the generated current required to achieve the given ramp-down time does not exceed the current limit (set in par. 4-18). Quick stop is activated by means of a signal on a selected digital input, or via the serial communication port.

2

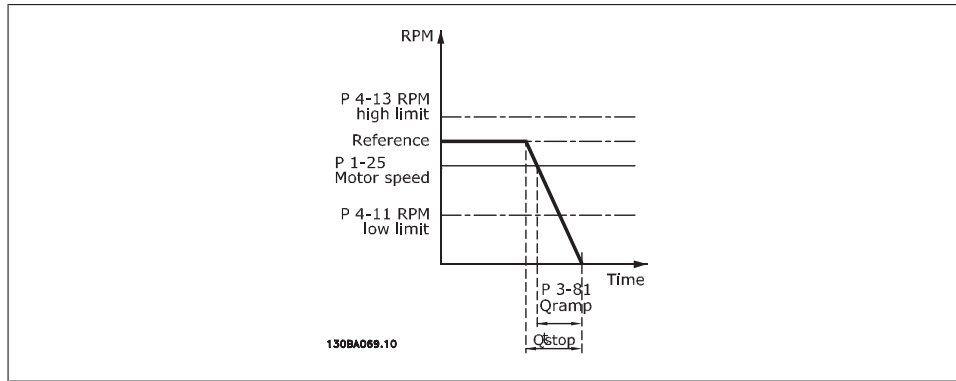

$$Par. 3 - 81 = \frac{t_{Qstop} [s] \times n_{M, N} (par. 1 - 25) [RPM]}{\Delta jog ref (par. 3 - 19) [RPM]}$$

2.6.9. 3-9 * Digital Potentiometer

The digital potentiometer function allows the user to increase or decrease the actual reference by adjusting the set-up of the digital inputs using the functions *Increase*, *Decrease* or *Clear*. To activate the function, at least one digital input must be set up to *Increase* or *Decrease*.

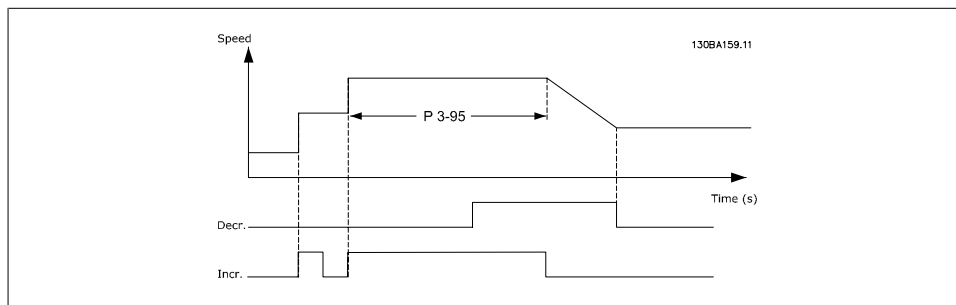
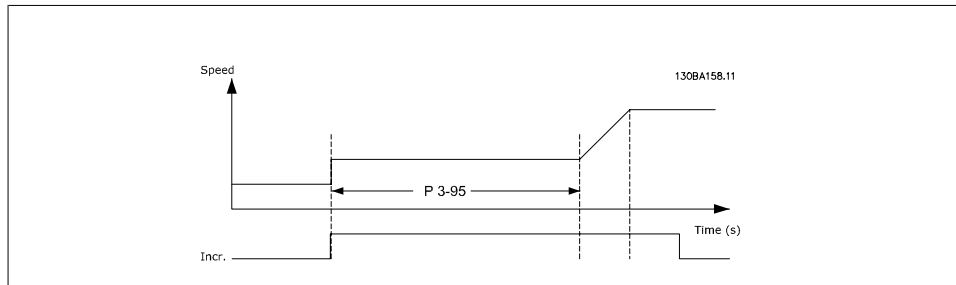

3-90 Step Size

Range:

0.10%* [0.01 - 200.00%]

Function:

Enter the increment size required for INCREASE/DECREASE as a percentage of the nominal speed set in par. 1-25. If INCREASE/DECREASE is activated, the resulting reference will be increased/decreased by the amount set in this parameter.

3-91 Ramp Time

Range:

1.00 s* [0.000 - 3600.00 s]

Function:

Enter the ramp time, i.e., the time for adjustment of the reference from 0% to 100% of the specified digital potentiometer function (Increase, Decrease or Clear).

If Increase/ Decrease is activated for longer than the ramp delay period specified in par. 3-95, the actual reference will be ramped up / down according to this ramp time. The ramp time is defined as the time used to adjust the reference by the step size specified in par. 3-90 *Step Size*.

3-92 Power Restore

Option:

[0] * Off

Function:

Resets the digital potentiometer reference to 0% after power-up.

[1] On

Restores the most recent digital potentiometer reference at power-up.

3-93 Maximum Limit

Range:

100%* [-200 - 200 %]

Function:

Set the maximum permissible value for the resulting reference. This is advisable if the digital potentiometer is used for fine tuning of the resulting reference.

3-94 Minimum Limit

Range:

-100%* [-200 - 200 %]

Function:

Set the minimum permissible value for the resulting reference. This is advisable if the digital potentiometer is used for fine tuning of the resulting reference.

3-95 Ramp Delay

Range:

1.000 s* [0.000 - 3,600.00 s]

Function:

Enter the delay required from activation of the digital potentiometer function until the adjustable frequency drive starts to ramp the reference. With a delay of 0 ms, the reference starts to ramp as soon as INCREASE/DECREASE is activated. See also par. 3-91 *Ramp Time*.

2.7. Parameters: Limits/Warnings

2

2.7.1. 4-** Limits and Warnings

Parameter group for configuring limits and warnings.

2.7.2. 4-1* Motor Limits

Define torque, current and speed limits for the motor, and the reaction of the adjustable frequency drive when the limits are exceeded.

A limit may generate a message on the display. A warning will always generate a message on the display or on the serial communication bus. A monitoring function may initiate a warning or a trip, upon which the adjustable frequency drive will stop and generate an alarm message.

4-10 Motor Speed Direction

Option:

Function:

Select the motor speed direction(s) required. Use this parameter to prevent unwanted reversing. When par. 1-00, *Configuration Mode*, is set to *Process* [3], par. 4-10 is set to *Clockwise* [0] as default. The setting in par. 4-10 does not limit options for setting par. 4-13.

This parameter cannot be adjusted while the motor is running.

[0] * Clockwise

[1] Counter-clockwise

[2] Both directions

4-11 Motor Speed Low Limit [RPM]

Range:

0 rpm* [0 - par. 4-13]

Function:

Enter the minimum limit for motor speed. The Motor Speed Low Limit can be set to correspond to the manufacturer's recommended minimum motor speed. The Motor Speed Low Limit must not exceed the setting in par. 4-13 *Motor Speed High Limit [RPM]*.

4-12 Motor Speed Low Limit [Hz]

Range:

0 Hz* [0 - par. 4-14]

Function:

Enter the minimum limit for motor speed. The motor speed low limit can be set to correspond to the minimum output frequency of the motor shaft. The Motor Speed Low Limit must not exceed the setting in par. 4-14 *Motor Speed High Limit [Hz]*.

4-13 Motor Speed High Limit [rpm]

| | |
|---|--|
| Range: 3,600 RPM [Par. 4-11 - 60.000] | Function: Enter the maximum limit for motor speed. The Motor Speed High Limit can be set to correspond to the manufacturer's maximum rated motor speed. The Motor Speed High Limit must exceed the setting in par. 4-11 <i>Motor Speed Low Limit [RPM]</i> . |
|---|--|

| | |
|---|--|
|  | <p>NOTE Max. output frequency cannot exceed 10% of the inverter switching frequency (par. 14-01).</p> |
|---|--|

4-14 Motor Speed High Limit [Hz]

| | |
|--|--|
| Range: Size re- [0 - 1000 Hz] lated* | Function: Enter the maximum limit for motor speed. The motor speed high limit can be set to correspond to the manufacturer's recommended maximum frequency of the motor shaft. The Motor Speed High Limit must exceed the setting in par. 4-12 <i>Motor Speed Low Limit [Hz]</i> . Only par. 4-11 or 4-12 will be displayed depending on other parameters set in the Main Menu, and depending on default settings specific to global geographical locations. |
|--|--|

| | |
|---|--|
|  | <p>NOTE Max. output frequency cannot exceed 10% of the inverter switching frequency (par. 14-01).</p> |
|---|--|

4-16 Torque Limit Motor Mode

| | |
|---|---|
| Range: 160.0 % [0.0 - Variable Limit * %] | Function: Sets the torque limit for motor operation. The torque limit is active in the speed range up to the rated motor speed (par. 1-25). To protect the motor from reaching the stalling torque, the default setting is 1.6 x the rated motor torque (calculated value). If a setting in par. 1-00 to par. 1-26 is changed, par. 4-16 to 4-18 are not automatically reset to the default settings. |
|---|---|

2

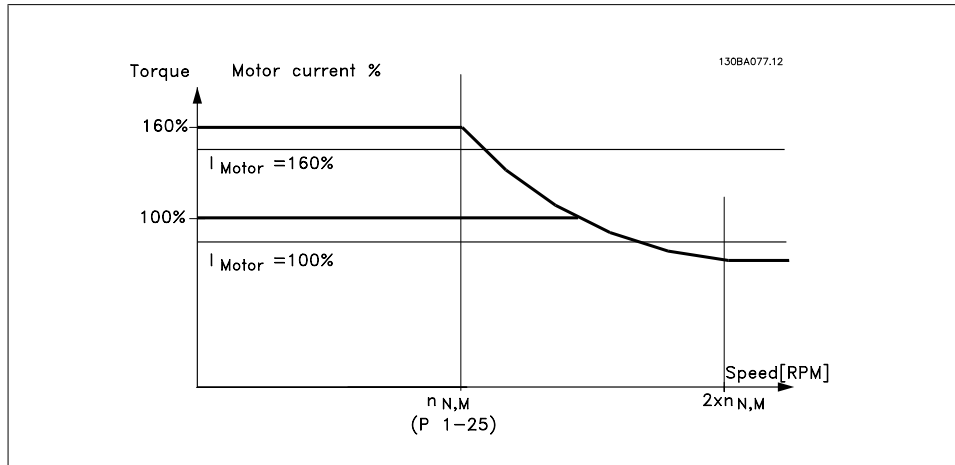

Changing par. 4-16, *Torque Limit Motor Mode*, when par. 1-00 is set to *Speed open-loop* [0], par. 1-66, *Min Current at Low Speed*, is automatically readjusted.

4-17 Torque Limit Generator Mode

Range:

100.0 % [0.0 - Variable Limit * %]

Function:

Sets the torque limit for generator mode operation. The torque limit is active in the speed range up to the rated motor speed (par. 1-25). Sets the torque limit for generator mode operation.

4-18 Current Limit

Range:

160.0 % [0.0 - Variable Limit * %]

Function:

Sets the current limit for motor operation. To protect the motor from reaching the stalling torque, the default setting is 1.6 x the rated motor torque (calculated value). If a setting in par. 1-00 to par. 1-26 is changed, par. 4-16 to par. 4-18 are not automatically reset to the default settings.

To obtain maximum output torque and prevent the motor from stalling, setting par. 4-18 lower than par. 4-16 and 4-17 (Torque Limits) is *not* recommended.

4-19 Max Output Frequency

Range:

132.0 [0.0 - 1,000.0 Hz] Hz*

Function:

Provides a final limit on the drive output frequency for improved safety for applications where accidental overspeeding must be prevented. This limit is final in all configurations (independent of the setting in par. 1-00).

| | |
|--|---|
| | <p>NOTE Max. output frequency cannot exceed 10% of the inverter switching frequency (par. 14-01).</p> |
|--|---|

Par. 4-19 cannot be adjusted while the motor is running.

4-20 Torque Limit Factor Source Option

| | |
|----------------|---|
| Option: | Function: |
| | Select an analog input for scaling the settings in par. 4-16 and 4-17 from 0% to 100% (or inverse). The signal levels corresponding to 0% and 100% are defined in the analog input scaling, such as par. group 6-1*, for example. This parameter is only active when par. 1-00 <i>Configuration Mode</i> is in <i>Speed Open-loop</i> or <i>Speed Closed-loop</i> . |

- [0] * No function
- [2] Analog input 53
- [4] Analog input 53 inv
- [6] Analog input 54
- [8] Analog input 54 inv
- [10] Analog input X30-11
- [12] Analog input X30-11 inv
- [14] Analog input X30-12
- [16] Analog input X30-12 inv

4-21 Speed Limit Factor Source Option

| | |
|----------------|--|
| Option: | Function: |
| | Select an analog input for scaling the settings in par. 4-19 from 0% to 100% (or inverse). The signal levels corresponding to 0% and 100% are defined in the analog input scaling, such as par. group 6-1*, for example. This parameter is only active when par. 1-00 <i>Configuration Mode</i> is in <i>Torque Mode</i> . |

- [0] * No function
- [2] Analog input 53
- [4] Analog input 53 inv
- [6] Analog input 54
- [8] Analog input 54 inv
- [10] Analog input X30-11
- [12] Analog input X30-11 inv
- [14] Analog input X30-12
- [16] Analog input X30-12 inv

2.7.3. 4-3* Motor Feedback Monitoring

The parameter group includes monitoring and handling of motor feedback devices such as encoders, resolvers, etc.

4-30 Motor Feedback Loss Function

Option:
Function:

Select which reaction the adjustable frequency drive should take in the case a feedback fault is detected. The selected action will take place if the feedback signal differs from the output speed by more than that specified in par. 4-31 during the time set in par. 4-32.

[0] Disabled

[1] Warning

[2] * Trip

4-31 Motor Feedback Speed Error

Range:

300 [1 - 600 rpm]
RPM*

Function:

Select the max. allowed tracking error in speed from the calculated and the actual mechanical shaft output speeds.

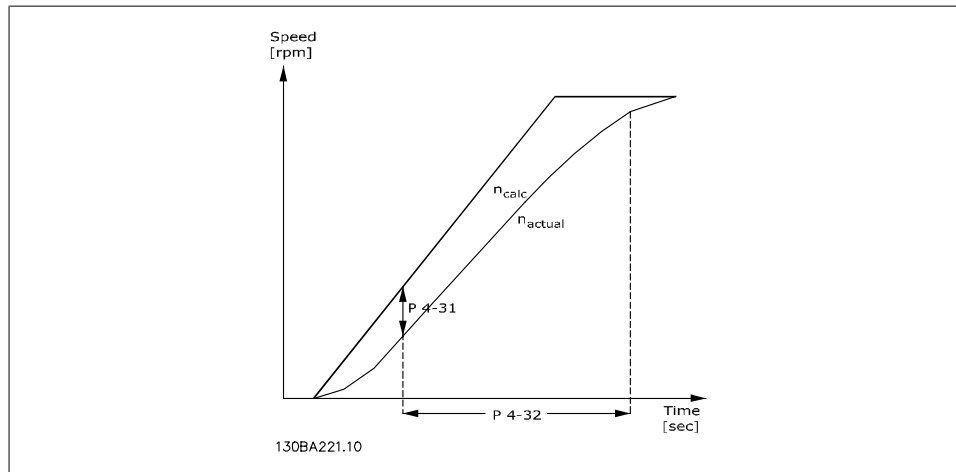

4-32 Motor Feedback Loss Timeout

Range:

0.05 s* [0.00 - 60.00 sec]

Function:

Set the timeout value that allows the speed error to be exceeded (set in par. 4-31).

2.7.4. 4-5* Adjustable Warnings

Define adjustable warning limits for current, speed, reference and feedback. Warnings are shown on the display, programmed output or serial bus.

Warnings are shown on display, programmed output or serial bus.

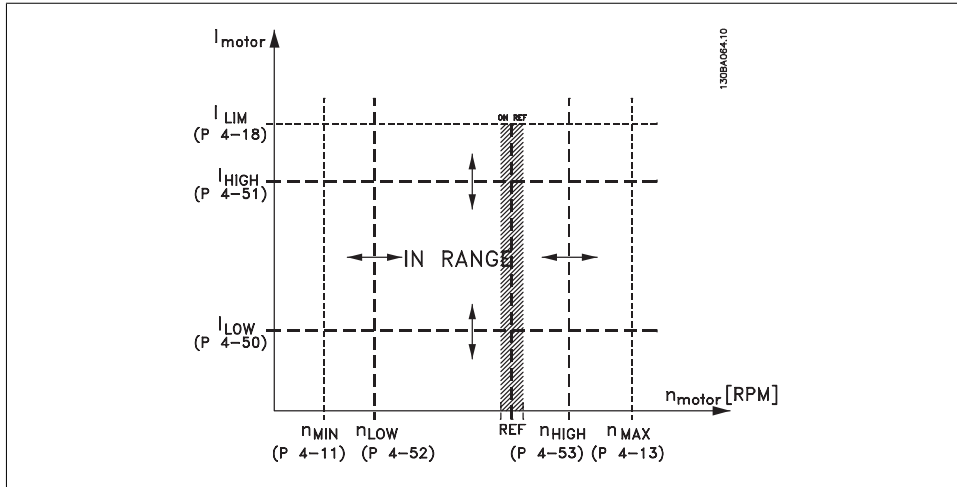

2

4-50 Warning Current Low

Range:

0.00 A* [0.00 - par. 4-51]

Function:

Enter the I_{LOW} value. When the motor current falls below this limit, the display reads *Current Low*. The signal outputs can be programmed to produce a status signal on terminal 27 or 29, and on relay output 01 or 02. Refer to the drawing in this section.

4-51 Warning Current High

Range:

par. [Par. 4-50 - par. 16-37
16-37
A*

Function:

Enter the I_{HIGH} value. When the motor current exceeds this limit, the display reads *Current High*. The signal outputs can be programmed to produce a status signal on terminal 27 or 29, and on relay output 01 or 02. Refer to the drawing in this section.

4-52 Warning Speed Low

Range:

0 rpm* [0 - par. 4-13]

Function:

Enter the n_{LOW} value. When the motor speed exceeds this limit, the display reads *Speed Low*. The signal outputs can be programmed to produce a status signal on terminal 27 or 29 (FC 302 only), and on relay output 01 or 02 (FC 302 only).

4-53 Warning Speed High

Range:

par. [Par. 4-52 - par. 4-13
4-13
rpm*

Function:

Enter the n_{HIGH} value. When the motor speed exceeds this limit, the display reads *Speed High*. The signal outputs can be programmed to produce a status signal on terminal 27 or 29, and

on relay output 01 or 02. Program the upper signal limit of the motor speed, n_{HIGH} , within the normal working range of the adjustable frequency drive. Refer to the drawing in this section.

4-54 Warning Reference Low

| | |
|---|---|
| Range: -999999 [-999999.999 - par. .999* 4-55] | Function: Enter the lower reference limit. When the actual reference falls below this limit, the display indicates <i>Ref Low</i> . The signal outputs can be programmed to produce a status signal on terminal 27 or 29, and on relay output 01 or 02. |
|---|---|

4-55 Warning Reference High

| | |
|---|--|
| Range: 999999. [Par. 4-54 999* 999999.999] | Function: - Enter the upper reference limit. When the actual reference exceeds this limit, the display reads <i>Ref High</i> . The signal outputs can be programmed to produce a status signal on terminal 27 or 29, and on relay output 01 or 02. |
|---|--|

4-56 Warning Feedback Low

| | |
|---|--|
| Range: -999999 [-999999.999 - par. .999* 4-57] | Function: Enter the lower feedback limit. When the feedback falls below this limit, the display reads <i>Feedb Low</i> . The signal outputs can be programmed to produce a status signal on terminal 27 or 29, and on relay output 01 or 02. |
|---|--|

4-57 Warning Feedback High

| | |
|---|---|
| Range: 999999. [Par. 4-56 999* 999999.999] | Function: - Enter the upper feedback limit. When the feedback exceeds this limit, the display reads <i>Feedb High</i> . The signal outputs can be programmed to produce a status signal on terminal 27 or 29, and on relay output 01 or 02. |
|---|---|

4-58 Missing Motor Phase Function

| | |
|---------------------------|---|
| Option: [0] Off | Function: Displays an alarm in the event of a missing motor phase. |
| [1] * On | No alarm displayed in the event of a missing motor phase. However, if the motor runs on only two phases, it can be damaged by overheating. Retaining the <i>On</i> setting is therefore strongly recommended. |

This parameter cannot be adjusted while the motor is running.

2.7.5. 4-6* Speed Bypass

Define the speed bypass areas for the ramps.
 Some systems call for avoiding certain output frequencies or speeds due to resonance problems in the system. A maximum of four frequency or speed ranges can be avoided.

4-60 Bypass Speed From [rpm]

Array [4]

4-60 Bypass Speed From [rpm]

| | |
|---|---|
| Range: 0 rpm* [0 - par. 4-13] | Function: Some systems call for avoiding certain output speeds due to resonance problems in the system. Enter the lower limits of the speeds to be avoided. |
|---|---|

4-61 Bypass Speed From [Hz]

Array [4]

| | |
|--------------------------|---|
| 0 Hz* [0 - par. 4-14 Hz] | Some systems call for avoiding certain output speeds due to resonance problems in the system. Enter the lower limits of the speeds to be avoided. |
|--------------------------|---|

4-62 Bypass Speed to [rpm]

Array [4]

| | |
|------------------------|---|
| 0 rpm* [0 - par. 4-13] | Some systems call for avoiding certain output speeds due to resonance problems in the system. Enter the upper limits of the speeds to be avoided. |
|------------------------|---|

4-63 Bypass Speed To [Hz]

Array [4]

| | |
|-----------------------|---|
| 0 Hz* [0 - par. 4-14] | Some systems call for avoiding certain output speeds due to resonance problems in the system. Enter the upper limits of the speeds to be avoided. |
|-----------------------|---|

2.8. Parameters: Digital In/Out

2

2.8.1. 5-** Digital In/Out

Parameter group for configuring the digital input and output.

2.8.2. 5-0* Digital I/O Mode

Parameters for configuring the IO mode. NPN/PNP and setting up IO to input or output.

5-00 Digital I/O Mode

Option:

Function:

Digital inputs and programmed digital outputs are pre-programmable for operation either in PNP or NPN systems.

[0] * PNP

Action on positive directional pulses (↑). PNP systems are pulled down to GND.

[1] NPN

Action on negative directional pulses (↓). NPN systems are pulled up to +24 V, internally in the adjustable frequency drive.



NOTE

When changing this parameter, a power cycle must be carried out before the parameter change is active.

This parameter cannot be adjusted while the motor is running.

5-01 Terminal 27 Mode

Option:

Function:

[0] * Input

Defines terminal 27 as a digital input.

[1] Output

Defines terminal 27 as a digital output.

This parameter cannot be adjusted while the motor is running.

5-02 Terminal 29 Mode

Option:

Function:

[0] * Input

Defines terminal 29 as a digital input.

[1] Output

Defines terminal 29 as a digital output.

This parameter is available for the FC 302 only.
This parameter cannot be adjusted while the motor is running.

2.8.3. 5-1* Digital Inputs

Parameters for configuring the input functions for the input terminals.
 The digital inputs are used for selecting various functions in the adjustable frequency drive. All digital inputs can be set to the following functions:

| Digital input function | Select | Terminal |
|------------------------------|--------|------------------|
| No operation | [0] | All *term 32, 33 |
| Reset | [1] | All |
| Coast inverse | [2] | All *term 27 |
| Coast and reset inverse | [3] | All |
| Quick stop inverse | [4] | All |
| DC brake inverse | [5] | All |
| Stop inverse | [6] | All |
| Start | [8] | All *term 18 |
| Latched start | [9] | All |
| Reversing | [10] | All *term 19 |
| Start reverse | [11] | All |
| Enable start forward | [12] | All |
| Enable start reverse | [13] | All |
| Jog | [14] | All *term 29 |
| Preset reference on | [15] | All |
| Preset ref bit 0 | [16] | All |
| Preset ref bit 1 | [17] | All |
| Preset ref bit 2 | [18] | All |
| Freeze reference | [19] | All |
| Freeze output | [20] | All |
| Speed up | [21] | All |
| Slow | [22] | All |
| Set-up select bit 0 | [23] | All |
| Set-up select bit 1 | [24] | All |
| Precise stop inverse | [26] | 18, 19 |
| Precise start, stop | [27] | 18, 19 |
| Catch up | [28] | All |
| Slow-down | [29] | All |
| Counter input | [30] | 29, 33 |
| Pulse input | [32] | 29, 33 |
| Ramp bit 0 | [34] | All |
| Ramp bit 1 | [35] | All |
| Line failure inverse | [36] | All |
| Latched precise start | [40] | 18, 19 |
| Latched precise stop inverse | [41] | 18, 19 |
| DigiPot Increase | [55] | All |
| DigiPot Decrease | [56] | All |
| DigiPot Clear | [57] | All |
| Counter A (up) | [60] | 29, 33 |
| Counter A (down) | [61] | 29, 33 |
| Reset Counter A | [62] | All |
| Counter B (up) | [63] | 29, 33 |
| Counter B (down) | [64] | 29, 33 |
| Reset Counter B | [65] | All |
| Mech. Brake Feedb. | [70] | All |
| Mech. Brake Feedb. Inv. | [71] | All |
| PTC Card 1 | [80] | All |

All = Terminals 18, 19, 27, 29, 32, 33, X30/2, X30/3, X30/4. X30/ are the terminals on MCB 101. Terminal 29 is available in the FC 302 only.

Functions dedicated to only one digital input are stated in the associated parameter.

All digital inputs can be programmed to these functions:

| | | |
|-----|--------------|---|
| [0] | No operation | No reaction to signals transmitted to the terminal. |
|-----|--------------|---|

2

| | | |
|--|-------------------------|--|
| [1] | Reset | Resets adjustable frequency drive after a TRIP/ALARM. Not all alarms can be reset. |
| [2] | Coast inverse | (Default Digital input 27): Coasting stop, inverted input (NC). The adjustable frequency drive leaves the motor in free mode. Logic '0' => coasting stop. |
| [3] | Coast and reset inverse | Reset and coasting stop Inverted input (NC). Leaves motor in free mode and resets drive. Logic '0' => coasting stop and reset. |
| [4] | Quick stop inverse | Inverted input (NC). Generates a stop in accordance with quick stop ramp time set in par. 3-81. When motor stops, the shaft is in free mode. Logic '0' => quick stop. |
| [5] | DC brake inverse | Inverted input for DC braking (NC). Stops motor by energizing it with a DC current for a certain time period. See par. 2-01 to par. 2-03. The function is only active when the value in par. 2-02 is different from 0. Logic "0" => DC braking. |
| [6] | Stop inverse | Stop Inverted function. Generates a stop function when the selected terminal goes from logical level '1' to '0'. The stop is performed according to the selected ramp time (par. 3-42, par. 3-52, par. 3-62, par. 3-72). |
| <div style="border: 1px solid black; padding: 5px;">  <p>NOTE When the adjustable frequency drive is at the torque limit and has received a stop command, it may not stop by itself. To ensure that the adjustable frequency drive stops, configure a digital output to <i>Torque limit & stop</i> [27] and connect this digital output to a digital input that is configured as coast.</p> </div> | | |
| [8] | Start | (Default Digital input 18): Select start for a start/stop command. Logic '1' = start, logic '0' = stop. |
| [9] | Latched start | The motor starts if a pulse is applied for a minimum of 2 ms. The motor stops when stop inverse is activated. |
| [10] | Reversing | (Default Digital input 19). Change the direction of motor shaft rotation. Select Logic '1' to reverse. The reverse signal only changes the direction of rotation. It does not activate the start function. Select both directions in par. 4-10 <i>Motor Speed Direction</i> . The function is not active in process closed-loop. |
| [11] | Start reverse | Used for start/stop and for reversing on the same wire. Signals on start are not allowed at the same time. |
| [12] | Enable start forward | Rotates motor shaft clockwise at start. |
| [13] | Enable start reverse | Rotates motor shaft counter-clockwise at start. |
| [14] | Jog | (Default Digital input 29): Use to activate jog speed. See par. 3-11. |

- [15] Preset reference on Shifts between external reference and preset reference. It is assumed that *External/preset*[1] has been selected in par. 3-04. Logic '0' = external reference active; logic '1' = one of the eight preset references is active.
- [16] Preset ref bit 0 Preset ref. bit 0, 1, and 2 enables a choice between one of the eight preset references according to the table below.
- [17] Preset ref bit 1 Same as Preset ref bit 0 [16].
- [18] Preset ref bit 2 Same as Preset ref bit 0 [16].

| | | | |
|-----------------|---|---|---|
| Preset ref. bit | 2 | 1 | 0 |
| Preset ref. 0 | 0 | 0 | 0 |
| Preset ref. 1 | 0 | 0 | 1 |
| Preset ref. 2 | 0 | 1 | 0 |
| Preset ref. 3 | 0 | 1 | 1 |
| Preset ref. 4 | 1 | 0 | 0 |
| Preset ref. 5 | 1 | 0 | 1 |
| Preset ref. 6 | 1 | 1 | 0 |
| Preset ref. 7 | 1 | 1 | 1 |

- [19] Freeze ref. Freezes the actual reference, which is now the point of enable/condition for *Speed up* and *Slow* to be used. If Speed up/Slow is used, the speed change always follows ramp 2 (par. 3-51 and 3-52) in the range 0 - par. 3-03 *Maximum Reference*.
- [20] Freeze output Freezes the actual motor frequency (Hz), which is now the point of enable/condition for *Speed up* and *Slow* to be used. If Speed up/Slow is used, the speed change always follows ramp 2 (par. 3-51 and 3-52) in the range 0 - par. 1-23 *Motor Frequency*.

NOTE
When freeze output is active, the adjustable frequency drive cannot be stopped via a low 'start [8]' signal. Stop the adjustable frequency drive via a terminal programmed for Coast inverse [2] or Coast and reset inv.

- [21] Speed up Select Speed up and Slow if digital control of the up/down speed is desired (motor potentiometer). Activate this function by selecting either Freeze reference or Freeze output. When Speed up/Slow is activated for less than 400 msec, the resulting reference will be increased/decreased by 0.1%. If Speed up/Slow is activated for more than 400 msec, the resulting reference will follow the setting in the ramping up/down parameter 3-x1/ 3-x2.

| | Shut down | Catch up |
|----------------------|-----------|----------|
| Unchanged speed | 0 | 0 |
| Reduced by %-value | 1 | 0 |
| Increased by %-value | 0 | 1 |
| Reduced by %-value | 1 | 1 |

2

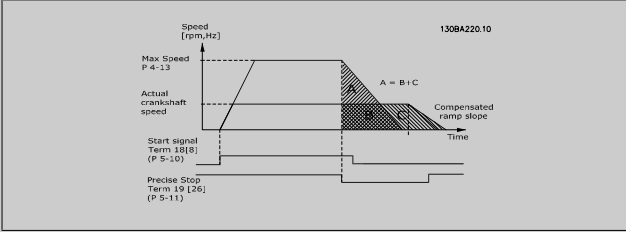
| | | |
|------|---------------------|--|
| [22] | Slow | Same as Speed up [21]. |
| [23] | Set-up select bit 0 | Select Set-up select bit 0 or 1 to select one of the four set-ups. Set par. 0-10 <i>Active Set-up</i> to Multi Set-up. |
| [24] | Set-up select bit 1 | (Default Digital input 32): Same as Set-up select bit 0 [23]. |
| [26] | Precise stop inv. | Prolongs stop signal to give a precise stop independent of speed. Sends an inverted stop signal when the precise stop function is activated in par. 1-83 <i>Precise Stop Function</i> . Precise stop inverse function is available for terminals 18 or 19. |
| [27] | Precise start, stop | Use when Precise ramp stop [0] is selected in par 1-83 <i>Precise stop function</i> .  |
| [28] | Catch up | Increases or reduces reference value set in par. 3-12. |
| [29] | Slow-down | Same as Catch up [28]. |
| [30] | Counter input | Precise stop function in par. 1-83 acts as a counter stop or speed compensated counter stop with or without reset. The counter value must be set in par. 1-84. |
| [32] | Pulse input | Use pulse sequence as either reference or feedback. Scaling is done in par. group 5-5*. |
| [34] | Ramp bit 0 | Enables a choice between one of the four ramps available, according to the table below. |
| [35] | Ramp bit 1 | Same as Ramp bit 0. |

| | | |
|-----------------|---|---|
| Preset ramp bit | 1 | 0 |
| Ramp 1 | 0 | 0 |
| Ramp 2 | 0 | 1 |
| Ramp 3 | 1 | 0 |
| Ramp 4 | 1 | 1 |

| | | |
|------|------------------------------|--|
| [36] | Line failure inverse | Activates par. 14-10 <i>Line Failure</i> . Line failure inverse is active in the logic "0" situation. |
| [41] | Latched Precise Stop inverse | Sends a latched stop signal when the precise stop function is activated in par. 1-83 <i>Precise Stop Function</i> . The latched precise stop inverse function is available for terminals 18 or 19. |
| [55] | DigiPot Increase | INCREASE signal to the digital potentiometer function described in parameter group 3-9*. |

| | | |
|------|----------------------------|---|
| [56] | DigiPot Decrease | DECREASE signal to the digital potentiometer function described in parameter group 3-9*. |
| [57] | DigiPot Clear | Clears the digital potentiometer reference described in parameter group 3-9*. |
| [60] | Counter A | (Terminal 29 or 33 only) Input for increment counting in the SLC counter. |
| [61] | Counter A | (Terminal 29 or 33 only) Input for decrement counting in the SLC counter. |
| [62] | Reset Counter A | Input for reset of counter A. |
| [63] | Counter B | (Terminal 29 or 33 only) Input for increment counting in the SLC counter. |
| [64] | Counter B | (Terminal 29 or 33 only) Input for decrement counting in the SLC counter. |
| [65] | Reset Counter B | Input for reset of counter B. |
| [70] | Mech. Brake Feed-back | Brake feedback for hoisting applications |
| [71] | Mech. Brake Feed-back inv. | Inverted brake feedback for hoisting applications |
| [80] | PTC Card 1 | All digital inputs can be set to PTC card 1 [80]. However, only one digital input must be set to this choice. |

5-10 Terminal 18 Digital Input

| | |
|----------------|---|
| Option: | Function: |
| [8] * Start | Select the function from the available digital input range. |

5-11 Terminal 19 Digital Input

| | |
|------------------|---|
| Option: | Function: |
| [10] * Reversing | Select the function from the available digital input range. |

5-12 Terminal 27 Digital Input

| | |
|---------------------|---|
| Option: | Function: |
| [2] * Coast inverse | Select the function from the available digital input range. |

5-13 Terminal 29 Digital Input

| | |
|----------------|---|
| Option: | Function: |
| | Select the function from the available digital input range and the additional options [60], [61], [63] and [64]. Counters are used in smart logic control functions. This parameter is available for the FC 302 only. |

[14] * Jog

| | |
|------|------------------|
| [60] | Counter A (up) |
| [61] | Counter A (down) |
| [63] | Counter B (up) |
| [64] | Counter B (down) |

5-14 Terminal 32 Digital Input

| Option: | Function: |
|--------------------|---|
| [0] * No operation | Select the function from the available digital input range. |

5-15 Terminal 33 Digital Input

| Option: | Function: |
|---------|--|
| | Select the function from the available digital input range and the additional options [60], [61], [63] and [64]. Counters are used in smart logic control functions. |

| |
|-----------------------|
| [0] * No operation |
| [60] Counter A (up) |
| [61] Counter A (down) |
| [63] Counter B (up) |
| [64] Counter B (down) |

5-16 Terminal X30/3 Digital Input

| Option: | Function: |
|--------------------|---|
| [0] * No operation | This parameter is active when option module MCB 101 is installed in the adjustable frequency drive. Follow the function stated in 5-1* |

5-17 Terminal X30/4 Digital Input

| Option: | Function: |
|--------------------|---|
| [0] * No operation | This parameter is active when option module MCB 101 is installed in the adjustable frequency drive. Follow the function stated in 5-1* |

5-18 Terminal X30/4 Digital Input

| Option: | Function: |
|--------------------|---|
| [0] * No operation | This parameter is active when option module MCB 101 is installed in the adjustable frequency drive. Follow the function stated in 5-1* |

5-19 Terminal 37 Safe Stop

| Option: | Function: |
|--------------------------|--|
| [1] * Safe Stop Alarm | Coasts adjustable frequency drive when safe stop is activated. Manual reset from LCP, digital input or serial communication bus. |
| [3] Safe Stop Auto Reset | Coasts adjustable frequency drive when safe stop is activated (term 37 off). When safe stop circuit is reestablished, the drive will continue without manual reset. |
| [4] PTC 1 Alarm | Coasts adjustable frequency drive when safe stop is activated. Manual reset from LCP, digital input or serial communication bus. Choice 4 is only available when the MCB 112 PTC thermistor card is connected. |
| [5] PTC 1 Warning | Coasts adjustable frequency drive when safe stop is activated (term 37 off). When a safe stop circuit is reestablished, the drive will continue without manual reset, unless a digital input set to PTC Card 1 [80] is still enabled. Choice 5 is only available when the MCB 112 PTC thermistor card is connected. |
| [6] PTC 1 & Relay A | This choice is used when the PTC option is gated together with a stop button through a safety relay to T-37. Coasts adjustable frequency drive when safe stop is activated. Manual reset from LCP, digital input or serial communication bus. Choice 6 is only available when the MCB 112 PTC thermistor card is connected. |
| [7] PTC 1 & Relay W | This choice is used when the PTC option is gated together with a stop button through a safety relay to T-37. Coasts adjustable frequency drive when safe stop is activated (term 37 off). When safe stop circuit is reestablished, the drive will continue without manual reset, unless a digital input set to PTC card 1 [80] is (still) enabled. Choice 7 is only available when the MCB 112 PTC thermistor card is connected. |
| [8] PTC 1 & Relay A/W | This choice makes it possible to use a combination of alarm and warning. Choice 8 is only available when the MCB 112 PTC thermistor card is connected. |
| [9] PTC 1 & Relay W/A | This choice makes it possible to use a combination of alarm and warning. Choice 9 is only available when the MCB 112 PTC thermistor card is connected. |

 **NOTE**
When Auto Reset/ Warning is selected, the drive opens up for automatic restart.

Overview of functions, alarms and warnings

| Function | No. | PTC | Relay |
|-------------------|------|-----------------------|-----------------|
| No Function | [0] | - | - |
| Safe Stop Alarm | [1]* | - | Safe Stop [A68] |
| Safe Stop Warning | [3] | - | Safe Stop [W68] |
| PTC 1 Alarm | [4] | PTC 1 Safe Stop [A71] | - |
| PTC 1 Warning | [5] | PTC 1 Safe Stop [W71] | - |
| PTC 1 & Relay A | [6] | PTC 1 Safe Stop [A71] | Safe Stop [A68] |
| PTC 1 & Relay W | [7] | PTC 1 Safe Stop [W71] | Safe Stop [W68] |
| PTC 1 & Relay A/W | [8] | PTC 1 Safe Stop [A71] | Safe Stop [W68] |
| PTC 1 & Relay W/A | [9] | PTC 1 Safe Stop [W71] | Safe Stop [A68] |

W means warning, and A means alarm. For further information, see Alarms and Warnings in section *Troubleshooting* in the Design Guide or in the Instruction Manual.

A dangerous failure related to the safe stop will give alarm: Dangerous Failure [A72].

2.8.4. 5-3* Digital Outputs

Parameters for configuring the output functions for the output terminals. The two solid state digital outputs are common for terminals 27 and 29. Set the I/O function for terminal 27 in par. 5-01 *Terminal 27 Mode*, and set the I/O function for terminal 29 in par. 5-02 *Terminal 29 Mode*. These parameters cannot be adjusted while the motor is running.

| | | |
|------|-----------------------------|--|
| [0] | No operation | <i>Default for all digital outputs and relay outputs</i> |
| [1] | Control ready | The control board receives supply voltage. |
| [2] | Drive ready | The adjustable frequency drive is ready for operation and applies a supply signal to the control board. |
| [3] | Drive ready/remote control | The adjustable frequency drive is ready for operation and is in Auto On mode. |
| [4] | Enable/no warning | Ready for operation. No start or stop command has been given (start/disable). There are no warnings. |
| [5] | VLT running | Motor is running. |
| [6] | Running/no warning | Output speed is higher than the speed set in par. 1-81 <i>Min Speed for Function at Stop [RPM]</i> . The motor is running and there are no warnings. |
| [7] | Run in range/no warning | Motor is running within the programmed current and speed ranges set in par. 4-50 to par. 4-53. There are no warnings. |
| [8] | Run on reference/no warning | Motor runs at reference speed. |
| [9] | Alarm | An alarm activates the output. There are no warnings. |
| [10] | Alarm or warning | An alarm or a warning activates the output. |
| [11] | At torque limit | The torque limit set in par. 4-16 or par. 1-17 has been exceeded. |

| | | |
|------|-----------------------------------|---|
| [12] | Out of current range | The motor current is outside the range set in par. 4-18. |
| [13] | Below current, low | Motor current is lower than set in par. 4-50. |
| [14] | Above current, high | Motor current is higher than set in par. 4-51. |
| [15] | Out of speed range | Output frequency is outside the frequency range set in any limit parameter. |
| [16] | Below speed, low | Output speed is lower than the setting in par. 4-52. |
| [17] | Above speed, high | Output speed is higher than the setting in par. 4-53. |
| [18] | Out of feedback range | Feedback is outside the range set in par. 4-56 and 4-57. |
| [19] | Below feedback, low | Feedback is below the limit set in par. 4-56 <i>Warning Feedback Low.</i> |
| [20] | Above feedback, high | Feedback is above the limit set in par. 4-57 <i>Warning Feedback High.</i> |
| [21] | Thermal warning | The thermal warning turns on when the temperature exceeds the limit in the motor, the adjustable frequency drive, the brake resistor or the thermistor. |
| [22] | Ready, no thermal warning | The adjustable frequency drive is ready for operation and there is no overtemperature warning. |
| [23] | Remote, ready, no thermal warning | The adjustable frequency drive is ready for operation and is in auto on mode. There is no overtemperature warning. |
| [24] | Ready, no over/undervoltage | The adjustable frequency drive is ready for operation, and the line voltage is within the specified voltage range (see General Specifications section). |
| [25] | Reverse | <i>Reversing. Logic '1'</i> when CW rotation of the motor. <i>Logic '0'</i> when CCW rotation of the motor. If the motor is not rotating, the output will follow the reference. |
| [26] | Bus OK | Active communication (no timeout) via the serial communication port. |
| [27] | Torque limit and stop | Used in performing a coasting stop and in torque limit condition. If the adjustable frequency drive has received a stop signal and is at the torque limit, the signal is logic "0." |
| [28] | Brake, no brake warning | Brake is active and there are no warnings. |
| [29] | Brake ready, no fault | Brake is ready for operation and there are no faults. |
| [30] | Brake fault (IGBT) | Output is Logic '1' when the brake IGBT is short-circuited. Use this function to protect the adjustable frequency drive if there is a fault on the brake modules. Use the output/relay to cut out the line voltage from the adjustable frequency drive. |
| [31] | Relay 123 | The relay is activated when Control Word [0] is selected in parameter group 8-**. |

| | | | |
|------|-------------------------|-------|---|
| [32] | Mechanical control | brake | Enables control of an external mechanical brake; see description in the section <i>Control of Mechanical Brake</i> , and par. group 2-2*. |
| [33] | Safe stop activated | | Indicates that the safe stop on terminal 37 has been activated. (FC 302 only) |
| [40] | Out of ref range | | |
| [41] | Below reference, low | | |
| [42] | Above reference, high | | |
| [45] | Bus Ctrl | | |
| [46] | Bus Ctrl On at timeout | | |
| [47] | Bus Ctrl Off at timeout | | |
| [51] | MCO controlled | | |
| [55] | Pulse output | | |
| [60] | Comparator 0 | | See par. group 13-1*. If Comparator 0 is evaluated as TRUE, the output will be high. Otherwise, it will be low. |
| [61] | Comparator 1 | | See par. group 13-1*. If Comparator 1 is evaluated as TRUE, the output will be high. Otherwise, it will be low. |
| [62] | Comparator 2 | | See par. group 13-1*. If Comparator 2 is evaluated as TRUE, the output will be high. Otherwise, it will be low. |
| [63] | Comparator 3 | | See par. group 13-1*. If Comparator 3 is evaluated as TRUE, the output will be high. Otherwise, it will be low. |
| [64] | Comparator 4 | | See par. group 13-1*. If Comparator 4 is evaluated as TRUE, the output will be high. Otherwise, it will be low. |
| [65] | Comparator 5 | | See par. group 13-1*. If Comparator 5 is evaluated as TRUE, the output will be high. Otherwise, it will be low. |
| [70] | Logic Rule 0 | | See par. group 13-4*. If logic rule 0 is evaluated as TRUE, the output will be high. Otherwise, it will be low. |
| [71] | Logic Rule 1 | | See par. group 13-4*. If logic rule 1 is evaluated as TRUE, the output will be high. Otherwise, it will be low. |
| [72] | Logic Rule 2 | | See par. group 13-4*. If logic rule 2 is evaluated as TRUE, the output will be high. Otherwise, it will be low. |
| [73] | Logic Rule 3 | | See par. group 13-4*. If logic rule 3 is evaluated as TRUE, the output will be high. Otherwise, it will be low. |
| [74] | Logic Rule 4 | | See par. group 13-4*. If logic rule 4 is evaluated as TRUE, the output will be high. Otherwise, it will be low. |
| [75] | Logic Rule 5 | | See par. group 13-4*. If logic rule 5 is evaluated as TRUE, the output will be high. Otherwise, it will be low. |
| [80] | SL Digital Output A | | See par. 13-52 <i>SL Control Action</i> . The input will go high whenever the smart logic action [38] <i>Set dig. out. A high</i> is executed. The input will go low whenever the smart logic action [32] <i>Set dig. out. A low</i> is executed. |

| | | |
|-------|-------------------------|---|
| [81] | SL Digital Output B | See par. 13-52 <i>SL Control Action</i> . The input will go high whenever the smart logic action [39] <i>Set dig. out. A high</i> is executed. The input will go low whenever the smart logic action [33] <i>Set dig. out. A low</i> is executed. |
| [82] | SL Digital Output C | See par. 13-52 <i>SL Control Action</i> . The input will go high whenever the smart logic action [40] <i>Set dig. out. A high</i> is executed. The input will go low whenever the smart logic action [34] <i>Set dig. out. A low</i> is executed. |
| [83] | SL Digital Output D | See par. 13-52 <i>SL Control Action</i> . The input will go high whenever the smart logic action [41] <i>Set dig. out. A high</i> is executed. The input will go low whenever the smart logic action [35] <i>Set dig. out. A low</i> is executed. |
| [84] | SL Digital Output E | See par. 13-52 <i>SL Control Action</i> . The input will go high whenever the smart logic action [42] <i>Set dig. out. A high</i> is executed. The input will go low whenever the smart logic action [36] <i>Set dig. out. A low</i> is executed. |
| [85] | SL Digital Output F | See par. 13-52 <i>SL Control Action</i> . The input will go high whenever the smart logic action [43] <i>Set dig. out. A high</i> is executed. The input will go low whenever the smart logic action [37] <i>Set dig. out. A low</i> is executed. |
| [120] | Local reference active | Output is high when par. 3-13 <i>Reference Site</i> = [2] <i>Local</i> , or when par. 3-13 <i>Reference Site</i> = [0] <i>Linked to hand auto</i> while the LCP is in hand on mode. |
| [121] | Remote reference active | Output is high when par. 3-13 <i>Reference Site</i> = <i>Remote</i> [1] or <i>Linked to hand/auto</i> [0] while the LCP is in [Auto on] mode. |
| [122] | No alarm | Output is high when no alarm is present. |
| [123] | Start cmd. active | Output is high when there is an active start command (i.e., via digital input bus connection or [Hand on] or [Auto on]), and no stop or start command is active. |
| [124] | Running reverse | Output is high when the drive is running counter clockwise (the logical product of the status bits 'running' AND 'reverse'). |
| [125] | Drive in hand mode | Output is high when the drive is in hand on mode (as indicated by the LED light above [Hand on]). |
| [126] | Drive in auto mode | Output is high when the drive is in hand on mode (as indicated by the LED light above [Auto on]). |

5-30 Terminal 27 Digital Output

| Option: | Function: |
|------------------------------|---|
| [45] Bus ctrl. | Controls output via bus. The state of the output is set in par. 5-90. The output state is retained in the event of bus timeout. |
| [46] Bus ctrl. on at timeout | Controls output via bus. The state of the output is set in par. 5-90. In the event of a bus timeout, the output state is set high (On). |

- [47] Bus ctrl. off at timeout Controls output via bus. The state of the output is set in par. 5-90. In the event of a bus timeout, the output state is set low (Off).

5-31 Terminal 29 Digital Output

- | Option: | Function: |
|-------------------------------|---|
| [45] Bus ctrl. | Controls output via bus. The state of the output is set in par. 5-90. The output state is retained in the event of bus timeout. |
| [46] Bus ctrl. on at timeout | Controls output via bus. The state of the output is set in par. 5-90. In the event of a bus timeout, the output state is set high (On). |
| [47] Bus ctrl. off at timeout | Controls output via bus. The state of the output is set in par. 5-90. In the event of a bus timeout, the output state is set low (Off). |

This parameter only applies for the FC 302.

5-32 Terminal X30/6 Digital Output (MCB 101)

- | Option: | Function: |
|--------------------|--|
| [0] * No operation | This parameter is active when option module MCB 101 is mounted in the adjustable frequency drive. Follow the function stated in 5-3*. |

5-33 Terminal X30/7 Digital Output (MCB 101)

- | Option: | Function: |
|--------------------|--|
| [0] * No operation | This parameter is active when option module MCB 101 is mounted in the adjustable frequency drive. Follow the function stated in 5-3*. |

2.8.5. 5-4* Relays

Parameters for configuring the timing and the output functions for the relays.

5-40 Function Relay

- | Option: | Function: |
|----------------|--|
| | Relay 2 is included in FC 302 only. Par. 5-40 functions are as for par. 5-3*, including options 36 and 37. Par. 5-40 options are as for par. 5-30, including options 36 and 37. Relay 2 is included in FC 302 only. Relay 7, 8 and 9 are included in MCB 105 Relay option module. |

[1] (Relay 1)

[2] (Relay 2)

[7] Relay 7

- [8] Relay 8
- [9] Relay 9
- [36] Control word bit 11
- [37] Control word bit 12

5-41 On Delay, Relay

Array [8] (Relay 1 [0], Relay 2 [1], Relay 7 [6], Relay 8 [7], Relay 9 [8])

0.01 s* [0.01 - 600.00 s] Enter the delay of the relay cut-in time. Select one of available mechanical relays and MCO 105 in an array function. See par. 5-40.

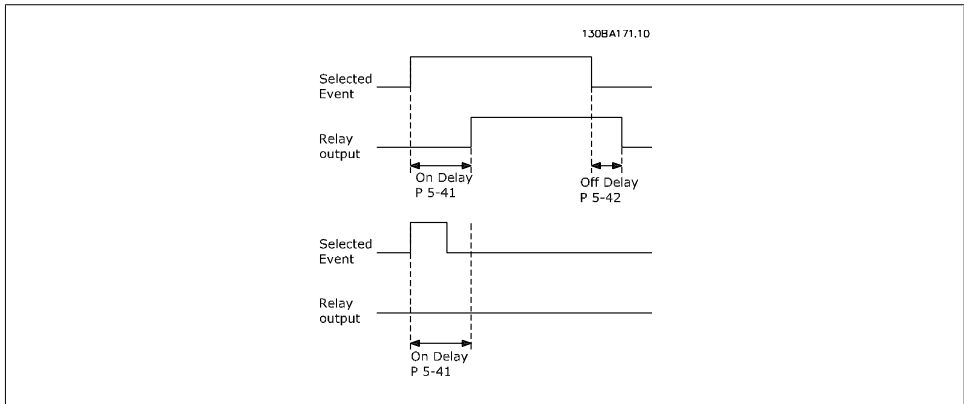

5-42 Off Delay, Relay

Array [8] (Relay 1 [0], Relay 2 [1], Relay 7 [6], Relay 8 [7], Relay 9 [8])

0.01 s* [0.01 - 600.00 s.] Enter the delay of the relay cut-out time. Select one of available mechanical relays and MCO 105 in an array function. See par. 5-40.

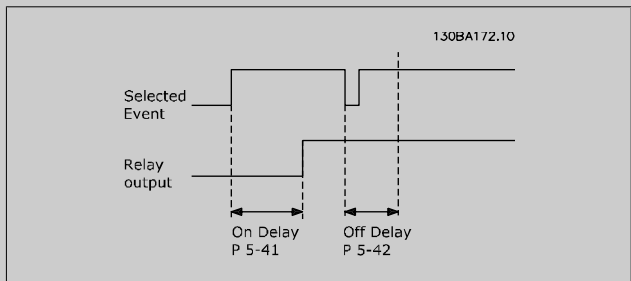

If the selected event condition changes before the on or off delay timer expires, the relay output is unaffected.

2

2.8.6. 5-5* Pulse Input

The pulse input parameters are used to define an appropriate window for the impulse reference area by configuring the scaling and filter settings for the pulse inputs. Input terminals 29 or 33 act as frequency reference inputs. Set terminal 29 (par. 5-13) or terminal 33 (par. 5-15) to *Pulse input* [32]. If terminal 29 is used as an input, then set par. 5-01 to *Input* [0].

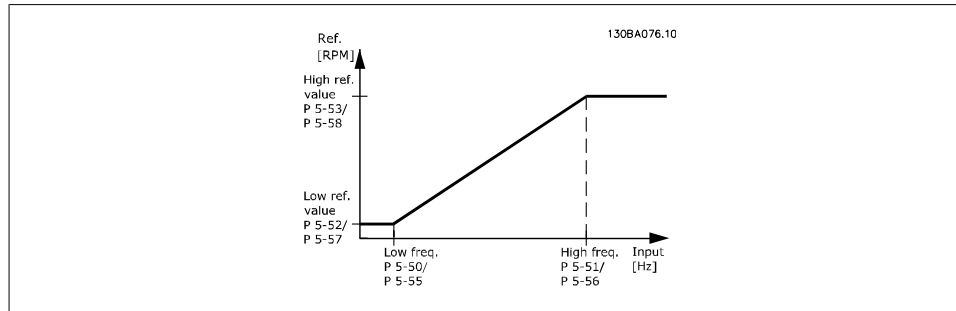

5-50 Term. 29 Low Frequency

Range:

100 Hz* [0 - 110,000 Hz]

Function:

Enter the low frequency limit corresponding to the low motor shaft speed (i.e., low reference value) in par. 5-52. Refer to the diagram in this section.

This parameter is available for the FC 302 only.

5-51 Term. 29 High Frequency

Range:

100 Hz [0 - 110,000 Hz]

Function:

Enter the high frequency limit corresponding to the high motor shaft speed (i.e., high reference value) in par. 5-52.

This parameter is available for the FC 302 only.

5-52 Term. 29 Low Ref./Feedb. Value

Range:

0.000* [-1000000.000 - par. 5-53]

Function:

Enter the low reference value limit for the motor shaft speed [rpm]. This is also the lowest feedback value; see also par. 5-57. Set terminal 29 to digital output (par. 5-02 = *Output* [1] and par. 5-13 = applicable value).

This parameter is available for the FC 302 only.

5-53 Term. 29 High Ref./Feedb. Value

Range:

1500.00 [Par. 5-52
0* 1000000.000]

Function:

- Enter the high reference value [rpm] for the motor shaft speed and the high feedback value; see also par. 5-58. Select terminal 29 as a digital output (par. 5-02 = *Output* [1] and par. 5-13 = applicable value).

This parameter is available for the FC 302 only.

5-54 Pulse Filter Time Constant #29

Range:

100 ms* [1 - 1,000 ms]

Function:

Enter the pulse filter time constant. The pulse filter dampens oscillations of the feedback signal, which is an advantage if there is a lot of noise in the system. A high time constant value results in better damping, but also increases the time delay through the filter. This parameter is available for the FC 302 only.

This parameter cannot be adjusted while the motor is running.

5-55 Term. 33 Low Frequency

Range:

100 Hz* [0 - 110,000 Hz]

Function:

Enter the low frequency corresponding to the low motor shaft speed (i.e., low reference value) in par. 5-57. Refer to the diagram in this section.

5-56 Term. 33 High Frequency

Range:

100 Hz* [0 - 110,000 Hz]

Function:

Enter the high frequency corresponding to the high motor shaft speed (i.e., high reference value) in par. 5-58.

5-57 Term. 33 Low Ref./Feedb. Value

Range:

0.000 * [-100000.000 - par. 5-58]

Function:

Enter the low reference value [RPM] for the motor shaft speed. This is also the low feedback value; see also par. 5-52.

5-58 Term. 33 High Ref./Feedb. Value

Range:

1500.00 [Par. 5-57
0* 100000.000]

Function:

- Enter the high reference value [rpm] for the motor shaft speed. See also par. 5-53, *Term. 29 High Ref./Feedb. Value*.

5-59 Pulse Filter Time Constant #33**Range:**

100 ms [1 - 1,000 ms]

Function:

Enter the pulse filter time constant. The low-pass filter reduces the influence on, and dampens oscillations in, the feedback signal from the control.

This is an advantage, if, for example, there is a great amount of noise in the system. This parameter cannot be adjusted while the motor is running.

2.8.7. 5-6* Pulse Outputs

Parameters for configuring the scaling and output functions of pulse outputs. The pulse outputs are designated for terminals 27 or 29. Select terminal 27 output in par. 5-01 and terminal 29 output in par. 5-02.

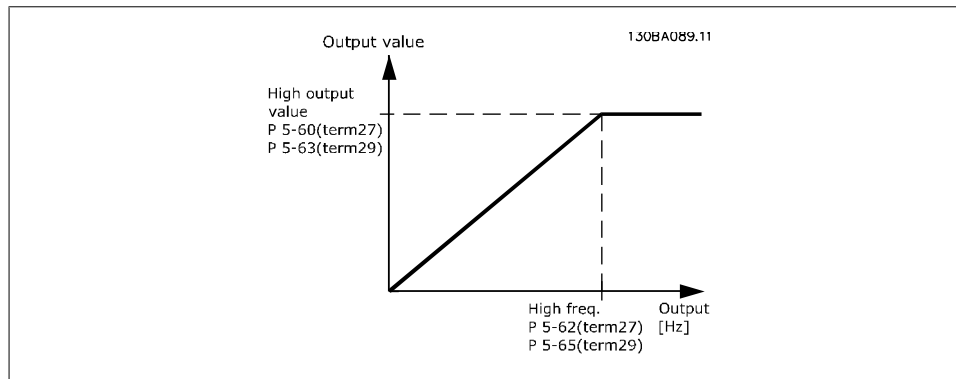

Options for readout output variables:

Parameters for configuring the scaling and output functions of pulse outputs. The pulse outputs are designated for terminals 27 or 29. Select terminal 27 output in par. 5-01 and terminal 29 output in par. 5-02.

- [0] * No operation
- [45] Bus control
- [48] Bus control timeout
- [51] MCO controlled
- [100] Output frequency
- [101] Reference
- [102] Feedback
- [103] Motor current
- [104] Torque relative to limit
- [105] Torque relative to rated

- [106] Power
- [107] Speed
- [108] Torque
- [109] Max Out Freq

5-60 Terminal 27 Pulse Output Variable

| | |
|------------------|---|
| Option: | Function: |
| [0] No operation | Select the variable for viewing on the terminal 27 display. This parameter cannot be adjusted while the motor is running. |

5-62 Pulse Output Maximum Frequency #27

| | |
|-------------------------|--|
| Range: | Function: |
| 5000 [0 - 32000 Hz] Hz* | Set the maximum frequency for terminal 27, corresponding to the output variable selected in par. 5-60. This parameter cannot be adjusted while the motor is running. |

5-63 Terminal 29 Pulse Output Variable

| | |
|--------------------|--|
| Option: | Function: |
| [0] * No operation | Select the variable for viewing on the terminal 29 display. This parameter is available for the FC 302 only. This parameter cannot be adjusted while the motor is running. |

5-65 Pulse Output Maximum Frequency #29

| | |
|---------------------------|--|
| Option: | Function: |
| [5000H 0 - 32000 Hz] z) * | Set the maximum frequency for terminal 29 corresponding to the output variable set in par. 5-63. This parameter cannot be adjusted while the motor is running. |

5-66 Terminal X30/6 Pulse Output Variable

| | |
|--------------------|--|
| Option: | Function: |
| [0] * No operation | Select the variable for readout on terminal X30/6. This parameter cannot be adjusted while the motor is running. This parameter is active when option module MCB 101 is installed in the adjustable frequency drive. |

5-68 Pulse Output Maximum Frequency #X30/6

| | |
|---------------------------|--|
| Range: | Function: |
| 5,000 [0 - 32,000 Hz] Hz* | Select the maximum frequency on terminal X30/6 by referring to the output variable in par. 5-66. This parameter cannot be adjusted while the motor is running. |

This parameter is active when option module MCB 101 is mounted in the adjustable frequency drive.

2

2.8.8. 5-7* 24 V Encoder Input

Parameters for configuring the 24 V encoder.

Connect the 24 V encoder to terminal 12 (24 V DC supply), terminal 32 (Channel A), terminal 33 (Channel B) and terminal 20 (GND). The digital inputs 32/33 are active for encoder inputs when *24 V encoder* is selected in par. 1-02 and par. 7-00. The encoder used is a dual channel (A and B) 24 V type. Max input frequency: 110 kHz.

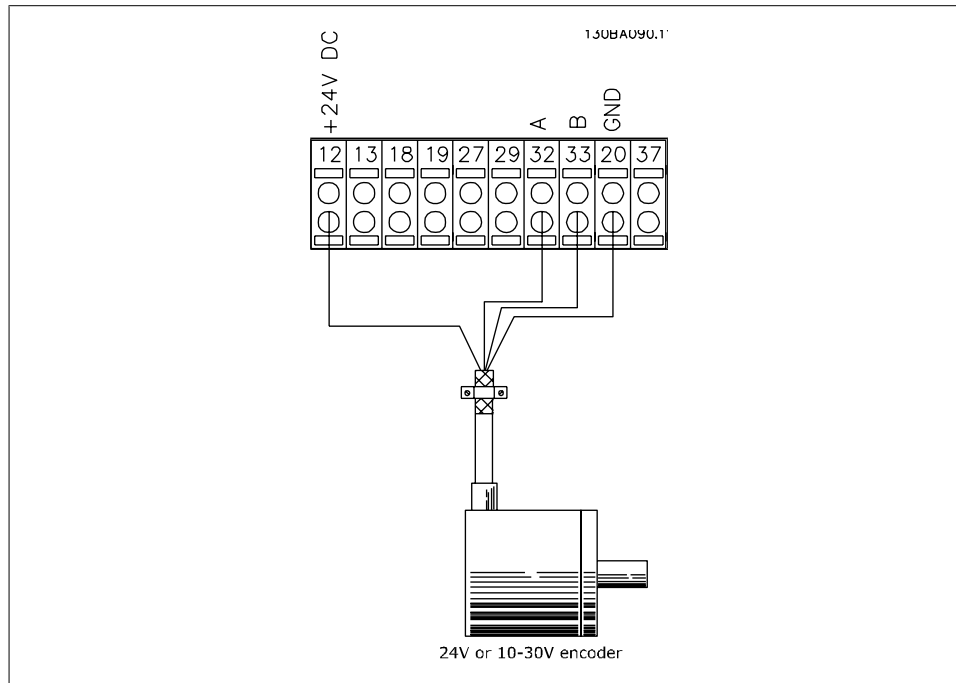

5-70 Term 32/33 Pulses per Revolution

Range:

1024PP [128 - 4096 PPR]
R*

Function:

Set the encoder pulses per revolution on the motor shaft. Read the correct value from the encoder.
This parameter cannot be adjusted while the motor is running.

5-71 Term 32/33 Encoder Direction

Option:

Function:

Change the detected encoder rotation direction without changing the wiring to the encoder.

[0] * Clockwise

Sets channel A 90° (electrical degrees) behind channel B upon clockwise rotation of the encoder shaft.

- [1] Counter-clockwise Sets channel A 90° (electrical degrees) ahead of channel B upon clockwise rotation of the encoder shaft.

This parameter cannot be adjusted while the motor is running.

2.8.9. 5-9* Bus Controlled

This parameter group selects digital and relay outputs via a serial communication bus setting.

5-90 Digital & Relay Bus Control

Option: [0] * 0 - FFFFFFFF
Function: This parameter holds the state of the digital outputs and relays that are controlled by the bus. A logical '1' indicates that the output is high or active. A logical '0' indicates that the output is low or inactive.

| | |
|-----------|----------------------------------|
| Bit 0 | Digital Output Terminal 27 |
| Bit 1 | Digital Output Terminal 29 |
| Bit 2 | Digital Output Terminal X 30/6 |
| Bit 3 | Digital Output Terminal X 30/7 |
| Bit 4 | Relay 1 output terminal |
| Bit 5 | Relay 2 output terminal |
| Bit 6 | Option B Relay 1 output terminal |
| Bit 7 | Option B Relay 2 output terminal |
| Bit 8 | Option B Relay 3 output terminal |
| Bit 9-15 | Reserved for future terminals |
| Bit 16 | Option C Relay 1 output terminal |
| Bit 17 | Option C Relay 2 output terminal |
| Bit 18 | Option C Relay 3 output terminal |
| Bit 19 | Option C Relay 4 output terminal |
| Bit 20 | Option C Relay 5 output terminal |
| Bit 21 | Option C Relay 6 output terminal |
| Bit 22 | Option C Relay 7 output terminal |
| Bit 23 | Option C Relay 8 output terminal |
| Bit 24-31 | Reserved for future terminals |

5-93 Pulse Output #27 Bus Control

Range: 0%* [0.00 - 100.00%]
Function: Set the output frequency transferred to the output terminal 27 when the terminal is configured as 'Bus Controlled' in par. 5-60 [45].

5-94 Pulse Output #27 Timeout Preset

Range: 0.00%* [0.00 - 100.00%]
Function: Set the output frequency transferred to the output terminal 27 when the terminal is configured as 'Bus Ctrl Timeout' in par. 5-60 [48]. And a timeout is detected.

5-95 Pulse Output #29 Bus Control**Range:**

0%* [0.00 - 100.00%]

Function:

Set the output frequency transferred to the output terminal 29 when the terminal is configured as 'Bus Controlled' in par. 5-60 [45].

This parameter only applies for the FC 302.

5-96 Pulse Output #29 Timeout Preset**Range:**

0.00%* [0.00 - 100.00%]

Function:

Set the output frequency transferred to the output terminal 29 when the terminal is configured as 'Bus Ctrl Timeout' in par. 5-60 [48]. And a timeout is detected.

This parameter only applies for the FC 302.

2.9. Parameters: Analog In/Out

2.9.1. 6-** Analog In/Out

Parameter group for configuring the analog input and output.

2.9.2. 6-0* Analog I/O Mode

The analog inputs can freely be allocated to be either voltage (FC 301: 0..10 V, FC 302: 0..+/-10 V) or current (FC 301/302: 0/4..20 mA) input.



NOTE

Thermistors may be connected to either an analog or a digital input.

6-00 Live Zero Timeout Time

Range:

10 s* [1 - 99 s]

Function:

Enter the Live Zero Timeout time period. Live Zero Timeout Time is active for analog inputs, (i.e., terminal 53 or terminal 54), allocated to current and used as reference or feedback sources. If the reference signal value associated with the selected current input falls below 50% of the value set in par. 6-10, par. 6-12, par. 6-20 or par. 6-22 for a period of time longer than that set in par. 6-00, the function selected in par. 6-01 will be activated.

6-01 Live Zero Timeout Function

Option:

Function:

Select the timeout function. The function set in par. 6-01 will be activated if the input signal on terminal 53 or 54 is below 50% of the value in par. 6-10, par. 6-12, par. 6-20 or par. 6-22 for a time period defined in par. 6-00. If several timeouts occur simultaneously, the adjustable frequency drive prioritizes the timeout functions as follows:

1. Par. 6-01 *Live Zero Timeout Function*
2. Par. 5-74 *Encoder Loss Function*
3. Par. 8-04 *Control Word Timeout Function*

The output frequency of the adjustable frequency drive can be:

The output frequency of the adjustable frequency drive can be:

- [1] frozen at the present value
- [2] overruled to stop
- [3] overruled to jog speed

- [4] overruled to max. speed
- [5] overruled to stop with subsequent trip

| | |
|-------|---------------|
| [0] * | Off |
| [1] | Freeze Output |
| [2] | Stop |
| [3] | Jogging |
| [4] | Max. speed |
| [5] | Stop and trip |

2.9.3. 6-1* Analog Input 1

Parameters for configuring the scaling and limits for analog input 1 (terminal 53).

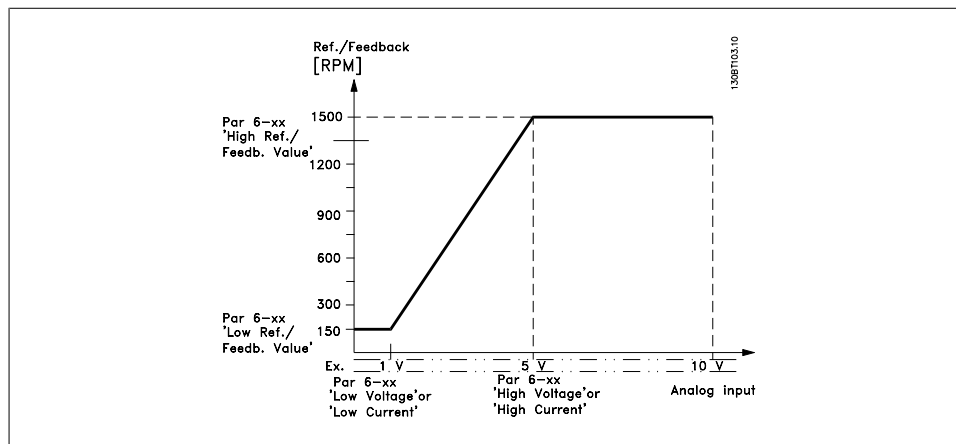

6-10 Terminal 53 Low Voltage

Range:

0.07 V* [FC 301: 0 V - par. 6-11]
 [FC 302: -10 V - par. 6-11] See also the section *Reference Handling*.

Function:

6-11 Terminal 53 High Voltage

Range:

10.0 V* [Par. 6-10 to 10.0 V] Enter the high voltage value. This analog input scaling value should correspond to the high reference/feedback value set in par. 6-15.

Function:

6-12 Terminal 53 Low Current

| | |
|--------------------------------|--|
| Range: | Function: |
| 0.14 mA* [0.0 to par. 6-13 mA] | Enter the low current value. This reference signal should correspond to the minimum reference value set in par. 3-02. The value must be set at >2 mA in order to activate the live zero timeout function in par. 6-01. |

6-13 Terminal 53 High Current

| | |
|------------------------------------|---|
| Range: | Function: |
| 20.0 mA* [Par. 6-12 to - 20.0 mA] | Enter the high current value corresponding to the high reference/feedback set in par. 6-15. |

6-14 Terminal 53 Low Ref./Feedb. Value

| | |
|---|---|
| Range: | Function: |
| 0.000 Unit* [-1000000.000 to par. 6-15] | Enter the analog input scaling value that corresponds to the low voltage/low current set in par. 6-10 and 6-12. |

6-15 Terminal 53 High Ref./Feedb. Value

| | |
|--|--|
| Range: | Function: |
| 1500.00 Unit* [Par. 6-14 to 1000000.000] | Enter the analog input scaling value that corresponds to the maximum reference feedback value set in par. 6-11 and 6-13. |

6-16 Terminal 53 Filter Time Constant

| | |
|-----------------------------|---|
| Range: | Function: |
| 0.001 s* [0.001 - 10.000 s] | Enter the time constant. This is a first-order digital low pass filter time constant for suppressing electrical noise in terminal 53. A high time constant value improves damping, but also increases the time delay through the filter. This parameter cannot be adjusted while the motor is running. |

2.9.4. 6-2* Analog Input 2

Parameters for configuring the scaling and limits for analog input 2 (terminal 54).

6-20 Terminal 54 Low Voltage

| | |
|--|---|
| Range: | Function: |
| 0.07 V* [FC 301: 0 V - par. 6-11] [FC 302: -10 V - par. 6-11] | Enter the low voltage value. This analog input scaling value should correspond to the minimum reference value, set in par. 3-02. See also the section <i>Reference Handling</i> . |

6-21 Terminal 54 High Voltage

| | |
|-------------------------------|--|
| Range: | Function: |
| 10.0 V* [Par. 6-20 to 10.0 V] | Enter the high voltage value. This analog input scaling value should correspond to the high reference/feedback value set in par. 6-25. |

6-22 Terminal 54 Low Current

| | |
|--------------------------------|--|
| Range: | Function: |
| 0.14 mA* [0.0 to par. 6-23 mA] | Enter the low current value. This reference signal should correspond to the minimum reference value set in par. 3-02. The value must be set at >2 mA in order to activate the live zero timeout function in par. 6-01. |

6-23 Terminal 54 High Current

| | |
|-----------------------------------|---|
| Range: | Function: |
| 20.0 mA* [Par. 6-22 to - 20.0 mA] | Enter the high current value corresponding to the high reference/feedback value set in par. 6-25. |

6-24 Terminal 54 Low Ref./Feedb. Value

| | |
|---|---|
| Range: | Function: |
| 0.000 Unit* [-1000000.000 to par. 6-25] | Enter the analog input scaling value that corresponds to the minimum reference feedback value set in par. 3-02. |

6-25 Terminal 54 high ref./feedb. value

| | |
|--|---|
| Range: | Function: |
| 1500.00 Unit* [Par. 6-24 to 1000000.000] | Enter the analog input scaling value that corresponds to the maximum reference feedback value set in par. 3-03. |

6-26 Terminal 54 Filter Time Constant

| | |
|-----------------------------|---|
| Range: | Function: |
| 0.001 s* [0.001 - 10.000 s] | Enter the time constant. This is a first-order digital low pass filter time constant for suppressing electrical noise in terminal 54. A high time constant value improves damping, but also increases the time delay through the filter. This parameter cannot be adjusted while the motor is running. |

2.9.5. 6-3* Analog Input 3 (MCB 101)

Parameter group used for configuring the scale and limiting analog input 3 (X30/11) placed on option module MCB 101.

6-30 Term. X30/11 Low Voltage

| | |
|-------------------------|---|
| Range: | Function: |
| 0.07 V* [0 - par. 6-31] | Sets the analog input scaling value to correspond to the low reference/feedback value (set in par. 6-34). |

6-31 Term. X30/11 High Voltage

| | |
|-------------------------------|--|
| Range: | Function: |
| 10.0 V* [Par. 6-30 to 10.0 V] | Sets the analog input scaling value to correspond to the high reference/feedback value (set in par. 6-35). |

6-34 Term. X30/11 Low Ref./Feedb. Value

| | |
|--|--|
| Range: | Function: |
| 0.000 [1000000.000 to par. Unit* 6-35] | Sets the analog input scaling value to correspond to the low voltage value (set in par. 6-30). |

6-35 Term. X30/11 High Ref./Feedb. Value

| | |
|--|---|
| Range: | Function: |
| 1,500.0 [Par. 6-34 to 00 Unit 1000000.000] | Sets the analog input scaling value to correspond to the high voltage value (set in par. 6-31). |

6-36 Term. X30/11 Filter Time Constant

| | |
|-----------------------------|---|
| Range: | Function: |
| 0.001 s* [0.001 - 10.000 s] | A 1 st order digital low pass filter time constant for suppressing electrical noise on terminal X30/11. Par. 6-36 cannot be changed while the motor is running. |

2.9.6. 6-4* Analog Input 4 (MCB 101)

Parameter group used for configuring the scale and limiting analog input 3 (X30/12) placed on option module MCB 101.

6-40 Term. X30/12 Low Voltage

| | |
|-------------------------|---|
| Range: | Function: |
| 0.7 V* [0 to par. 6-41] | Sets the analog input scaling value to correspond to the low reference/feedback value set in par. 6-44. |

6-41 Term. X30/12 High Voltage

| | |
|-------------------------------|--|
| Range: | Function: |
| 10.0 V* [Par. 6-40 to 10.0 V] | Sets the analog input scaling value to correspond to the high reference/feedback value set in par. 6-45. |

6-44 Term. X30/12 Low Ref./Feedb. Value

| | |
|---|--|
| Range: | Function: |
| 0.000 [-1000000.000 to par. Unit* 6-45] | Sets the analog input scaling value to correspond to the low voltage value set in par. 6-44. |

6-45 Term. X30/12 High Ref./Feedb. Value

| | |
|---|---|
| Range: | Function: |
| 1,500.0 [Par. 6-44 to 00 Unit* 1000000.000] | Sets the analog input scaling value to correspond to the high voltage value set in par. 6-41. |

6-46 Term. X30/12 Filter Time Constant

| | |
|-----------------------------|---|
| Range: | Function: |
| 0.001 s* [0.001 - 10.000 s] | A 1 st order digital low pass filter time constant for suppressing electrical noise on terminal X30/12. Par. 6-46 cannot be changed while the motor is running. |

2.9.7. 6-5* Analog Output 1

Parameters for configuring the scaling and limits for analog output 1, i.e., Terminal 42. Analog outputs are current outputs: 0/4 – 20 mA. Common terminal (terminal 39) is the same terminal and has the same electrical potential for analog common and digital common connection. Resolution on analog output is 12 bit.

6-50 Terminal 42 Output

| | |
|----------------|---|
| Option: | Function: |
| | Select the function of terminal 42 as an analog current output. |
| [0] | No operation |
| [52] | MCO 305 0-20 mA |
| [53] | MCO 305 4-20 mA |
| [100] | Output frequency |
| [101] | Reference |
| [102] | Feedback |
| [103] | Motor current |
| [104] | Torque rel to lim |
| [105] | Torque rel to rated |
| [106] | Power |
| [107] | Speed |
| [108] | Torque |
| [109] | Max Out Freq 0-20 mA |
| [130] | Output freq. 4-20 mA |
| [131] | Reference 4-20 mA |
| [132] | Feedback 4-20 mA |

| | |
|-------|----------------------------|
| [133] | Motor cur. 4-20 mA |
| [134] | Torque % lim. 4-20 mA |
| [135] | Torque % nom 4-20 mA |
| [136] | Power 4-20 mA |
| [137] | Speed 4-20 mA |
| [138] | Torque 4-20 mA |
| [139] | Bus ctrl. 0-20 mA |
| [140] | Bus ctrl. 4-20 mA |
| [141] | Bus ctrl. 0-20 mA, timeout |
| [142] | Bus ctrl. 4-20 mA, timeout |
| [150] | Max Out Freq 4-20 mA |

6-51 Terminal 42 Output Min Scale

Range:
0%* [0 – 200%]

Function:
Scale the minimum output of the selected analog signal at terminal 42, as a percentage of the maximum signal value. For example, if 0 mA (or 0 Hz) is desired at 25% of the maximum output value, program it to 25%. Scaling values up to 100% can never be higher than the corresponding setting in par. 6-52.

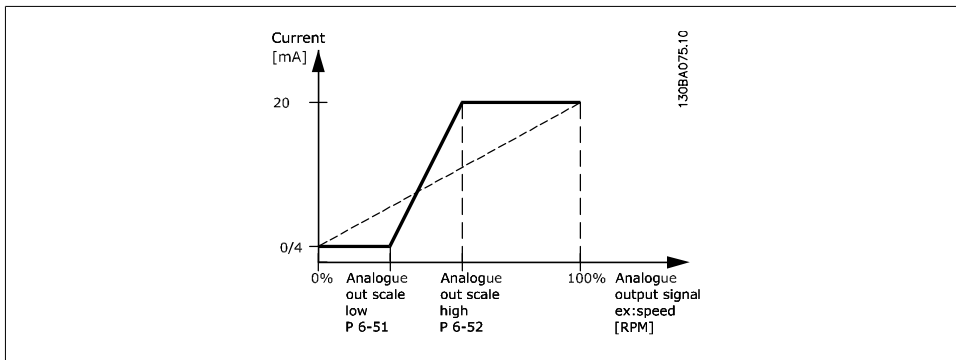

6-52 Terminal 42 Output Max Scale

Range:
100 %* [000 – 200%]

Function:
Scale the maximum output of the selected analog signal at terminal 42. Set the value to the maximum value of the current signal output. Scale the output to give a current lower than 20 mA at full scale, or 20 mA at an output below 100% of the maximum signal value. If 20 mA is the desired output current at a

value between 0-100% of the full-scale output, program the percentage value in the parameter, i.e., 50% = 20 mA. If a current between 4 and 20 mA is desired at maximum output (100%), calculate the percentage value as follows:

$$20 \text{ mA} / \text{desired maximum current} \times 100\% \quad \text{i.e. } 10 \text{ mA} : \frac{20}{10} \times 100 = 200\%$$

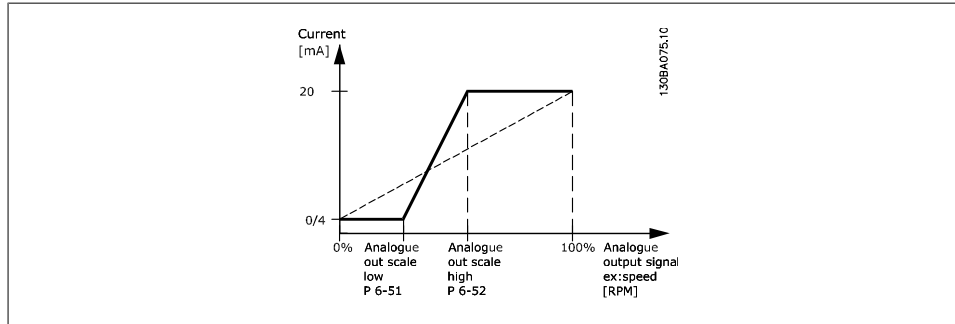

6-53 Terminal 42 Output Bus Control

Range:

0.00%* [0.00 – 100.00%]

Function:

Holds the level of Output 42 if controlled by bus.

6-54 Terminal 42 Output Timeout Preset

Range:

0.00%* [0.00 – 100.00%]

Function:

Holds the preset level of Output 42.

If a bus timeout and a timeout function are selected in par. 6-50, the output will preset to this level.

2.9.8. 6-6* Analog Output 2 (MCB 101)

Analog outputs are current outputs: 0/4 - 20 mA. Common terminal (terminal X30/7) is the same terminal and electrical potential for an analog common connection. Resolution on analog output is 12 bit.

6-60 Terminal X30/8 Output

Option:

Function:

[0] No operation

[100] Output frequency (0 - 1,000 Hz), 0.20 mA

[101] Output frequency (0 - 1,000 Hz), 4.20 mA
Reference (Ref min-max) 0.20 mA

[102] Reference (Ref min-max) 4.20 mA

| | |
|-------|--|
| | Feedback (FB min-max) 0.20 mA |
| [103] | Feedback (FB min-max) 4.20 mA Motor current (0-Imax) 0.20 mA |
| [104] | Motor current (0-Imax) 4.20 mA Torque relative to limit 0-Tlim, 0.20 mA |
| [105] | Torque relative to limit 0-Tlim, 4.20 mA Torque relative to rated 0-Tnom, 0.20 mA |
| [106] | Torque relative to rated 0-Tnom, 4.20 mA Power (0-Pnom), 0.20 mA |
| [107] | Power (0-Pnom), 4.20 mA Speed (0-Speedmax), 0.20 mA |
| [108] | Speed (0-Speedmax), 4.20 mA Torque (+/-160% torque), 0-20 mA |
| [130] | Torque (+/-160% torque), 4-20 mA Output freq. 4-20 mA |
| [131] | Reference 4-20 mA |
| [132] | Feedback 4-20 mA |
| [133] | Motor cur. 4-20 mA |
| [134] | Torque % lim. 4-20 mA |
| [135] | Torque % nom 4-20 mA |
| [136] | Power 4-20 mA |
| [137] | Speed 4-20 mA |
| [138] | Torque 4-20 mA |
| [139] | Bus Ctrl 0-20 mA |
| [140] | Bus Ctrl 4-20 mA |
| [141] | Bus Ctrl 0-20 mA, Timeout |
| [142] | Bus Ctrl 4-20 mA, Timeout |
| [150] | Max Out Freq 4-20 mA |

6-61 Term. X30/8 Output Min Scale

Range:

0%* [0.00 - 200 %]

Function:

Scales the minimum output of the selected analog signal on terminal X30/8. Scale the minimum value as a percentage of the maximum signal value, i.e., 0 mA (or 0 Hz) is desired at 25% of the maximum output value and 25% is programmed. The value can never be higher than the corresponding setting in par. 6-62 if value is below 100%.

This parameter is active when option module MCB 101 is mounted in the adjustable frequency drive.

6-62 Term. X30/8 Output Max Scale

Range:

100%* [0.00 - 200 %]

Function:

Scales the maximum output of the selected analog signal on terminal X30/8. Scale the value to the desired maximum value of the current signal output. Scale the output to give a current lower than 20 mA at full scale, or 20 mA at an output below 100% of the maximum signal value. If 20 mA is the desired output current at a value between 0 - 100% of the full-scale output, program the percentage value in the parameter, i.e., 50% = 20 mA. If a current between 4 and 20 mA is desired at maximum output (100%), calculate the percentage value as follows:

$20 \text{ mA} \mid \text{desired maximum current} \times 100 \%$

i.e. $10 \text{ mA} : \frac{20}{10} \times 100 = 200 \%$

2.10. Parameters: Controllers

2.10.1. 7-*** Controllers

Parameter group for configuring application controls.

2.10.2. 7-0* Speed PID Ctrl.

Parameters for configuring the speed PID control.

7-00 Speed PID Feedback Source

| | |
|----------------|---|
| Option: | Function: |
| | Select the encoder for closed-loop feedback. The feedback may come from an encoder (typically mounted on the application itself) other than the motor-mounted encoder feedback selected in par. 1-02. This parameter cannot be adjusted while the motor is running. |

- [0] Motor feedb. p.1-02 (FC 302 only)
- [1] 24 V encoder
- [2] MCB 102
- [3] MCB 103
- [4] MCO encoder 1
- [5] MCO encoder 2



NOTE
If separate encoders are used (for FC 302 only), the ramp settings parameters in the following groups must be adjusted according to the gear ratio between the two encoders: 3-4*, 3-5*, 3-6*, 3-7* and 3-8*.

7-02 Proportional Gain

| | |
|------------------------------|---|
| Range: | Function: |
| Size-related [0.000 - 1.000] | Enter the speed controller proportional gain. The proportional gain amplifies the error (i.e., the deviation between the feedback signal and the setpoint). This parameter is used with par. 1-00, <i>Speed open-loop</i> [0] and <i>Speed closed-loop</i> [1] control. Quick control is obtained at high amplification. However, if the amplification is too great, the process may become unstable. |

7-03 Speed PID Integral Time

| | |
|----------------------------|---|
| Range: | Function: |
| 8.0 ms* [2.0 - 20000.0 ms] | Enter the speed controller integral time, which determines the time the internal PID control takes to correct errors. The greater the error, the more quickly the gain increases. The integral time |

causes a delay of the signal and therefore a damping effect, and can be used to eliminate steady state speed error. Obtain quick control through a short integral time; but if the integral time is too short, the process becomes unstable. An excessively long integral time disables the integral action, leading to major deviations from the required reference, since the process regulator takes too long to regulate errors. This parameter is used with *Speed open-loop* [0] and *Speed closed-loop* [1] control, set in par. 1-00, *Configuration Mode*.

7-04 Speed PID Differentiation Time

Range:

30.0 ms [0.0 - 200.0 ms]

Function:

Enter the speed controller differentiation time. The differentiator does not react to constant error. It provides gain proportional to the rate of change of the speed feedback. The quicker the error changes, the stronger the gain from the differentiator. The gain is proportional with the speed at which errors change. Setting this parameter to zero disables the differentiator. This parameter is used with par. 1-00 *Speed closed-loop* [1] control.

7-05 Speed PID Diff Gain Limit

Range:

5.000* [1.0 - 20.0]

Function:

Set a limit for the gain provided by the differentiator. Since the differential gain increases at higher frequencies, limiting the gain may be useful. For example, set up a pure D-link at low frequencies and a constant D-link at higher frequencies. This parameter is used with par. 1-00 *Speed closed-loop* [1] control.

7-06 Speed PID Low-pass Filter Time

Range:

10.0 [1.0 - 100.0 ms]
ms*

Function:

Set a time constant for the speed control low-pass filter. The low-pass filter improves steady-state performance and dampens oscillations on the feedback signal. This is an advantage if there is a great amount of noise in the system; see illustration below. For example, if a time constant (τ) of 100 ms is programmed, the cut-off frequency for the low-pass filter will be $1/0.1 = 10 \text{ RAD/sec.}$, corresponding to $(10/2 \times \pi) = 1.6 \text{ Hz}$. The PID regulator only regulates a feedback signal that varies by a frequency of less than 1.6 Hz. If the feedback signal varies by a frequency higher than 1.6 Hz, the PID regulator does not react.

Note that severe filtering can be detrimental to dynamic performance.

This parameter is used with par. 1-00 *Speed closed-loop* [1] and *Torque* [2] control.

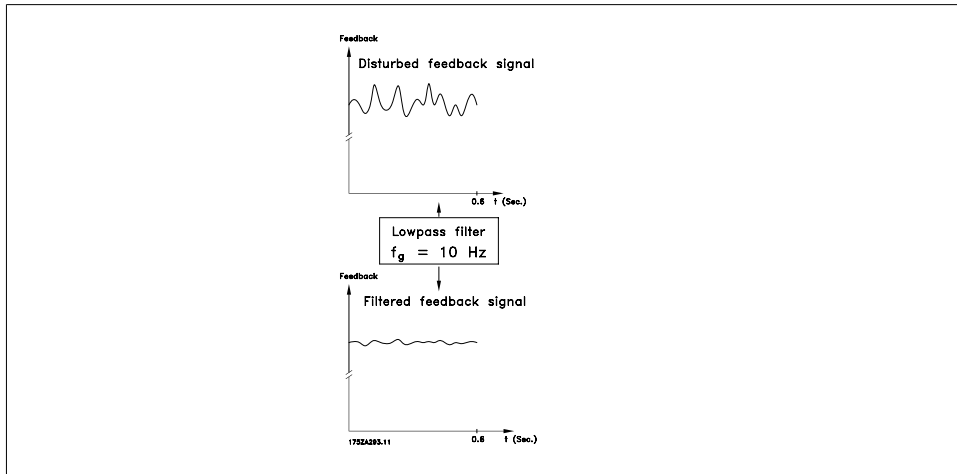

7-08 Speed PID Feed Forward Factor

Range:
0%* [0 - 500%]

Function:
The reference signal bypasses the speed controller by the amount specified. This feature increases the dynamic performance of the speed control loop.

2.10.3. 7-2* Process Ctrl. Feedb.

Select the feedback sources for the process PID control, and the way in which this feedback should be handled.

7-20 Process CL Feedback 1 Source

Option:

Function:
The effective feedback signal is made up of the sum of up to two different input signals. Select which adjustable frequency drive input should be treated as the source of the first of these signals. The second input signal is defined in par. 7-22.

- [0] * No function
- [1] Analog input 53
- [2] Analog input 54
- [3] Frequency input 29 (FC 302 only)
- [4] Frequency input 33
- [5] Bus feedback 1
- [6] Bus feedback 2
- [7] Analog input X30/11
- [8] Analog input X30/12

7-22 Process CL Feedback 2 Source

Option:
Function:

The effective feedback signal is made up of the sum of up to two different input signals. Select which adjustable frequency drive input should be treated as the source of the second of these signals. The first input signal is defined in par. 7-21.

[0] * No function

[1] Analog input 53

[2] Analog input 54

[3] Frequency input 29
(FC 302 only)

[4] Frequency input 33

[5] Bus feedback 1

[6] Bus feedback 2

[7] Analog input X30/11

[8] Analog input X30/12

2.10.4. 7-3* Process PID Ctrl.

Parameters for configuring the Process PID control.

7-30 Process PID Normal/Inverse Control

Option:
Function:

Normal and inverse control are implemented by introducing a difference between the reference signal and the feedback signal.

[0] * Normal

Sets process control in order to increase the output frequency.

[1] Inverse

Sets process control in order to reduce the output frequency.

7-31 Process PID Anti Wind-up

Option:
Function:

[0] * Off

Ceases regulation of an error when the output frequency can no longer be adjusted.

[1] On

Continues regulation of an error even when the output frequency cannot be increased or decreased.

7-32 Process PID Controller Start Value

Range:

0 rpm* [0 - 6,000 rpm]

Function:

Enter the motor speed to be attained as a start signal for commencement of PID control. When the power is switched on, the adjustable frequency drive will commence ramping and then operate under speed open-loop control. Afterwards, when the

process PID start speed is reached, the adjustable frequency drive will change over to process PID control.

7-33 Process PID Proportional Gain

| | |
|--|---|
| Range: 0.01 N/[0.00 - 10.00 N/A] A* | Function: Enter the PID proportional gain. The proportional gain multiplies the error between the setpoint and the feedback signal. |
|--|---|

7-34 Process PID Integral Time

| | |
|---|---|
| Range: 10,000. [0.01 - 10000.00] 00 s* | Function: Enter the PID integral time. The integrator provides an increasing gain at a constant error between the setpoint and the feedback signal. The integral time is the time needed by the integrator to reach the same gain as the proportional gain. |
|---|---|

7-35 Process PID Differentiation Time

| | |
|---|--|
| Range: 0.00 s* [0.00 - 10.00 s] | Function: Enter the PID differentiation time. The differentiator does not react to a constant error, but provides a gain only when the error changes. The shorter the PID differentiation time, the stronger the gain from the differentiator. |
|---|--|

7-36 Process PID Diff. Gain Limit

| | |
|---|---|
| Range: 5.0 N/[1.0 - 50.0 N/A] A* | Function: Enter a limit for the differentiator gain (DG). If there is no limit, the DG will increase when there are fast changes. Limit the DG to obtain a pure differentiator gain at slow changes, and a constant differentiator gain where fast changes occur. |
|---|---|

7-38 Process PID Feed Forward Factor

| | |
|---------------------------------|---|
| Range: 0%* [0 - 500%] | Function: Enter the PID feed forward (FF) factor. The FF factor sends a constant fraction of the reference signal to bypass PID control, which means that PID control only affects the remaining fraction of the control signal. Any change to this parameter will thus affect the motor speed. When the FF factor is activated, it provides less overshoot and high dynamics when changing the setpoint. Par. 7-38 is active when par. 1-00 <i>Configuration Mode</i> is set to [3] Process. |
|---------------------------------|---|

2**7-39 On Reference Bandwidth****Range:**

5%* [0 - 200%]

Function:

Enter the On Reference bandwidth. When the PID control error (the difference between the reference and the feedback) is less than the set value of this parameter, the On Reference status bit is high, i.e., it equals 1.

2.11. Parameters: Communications and Options

2.11.1. 8-** Comm. and Options

Parameter group for configuring communications and options.

2.11.2. 8-0* General Settings

General settings for communications and options.

| 8-01 Control Site | | |
|--------------------------|------------------------|---|
| Option: | | Function: |
| [0] * | Digital and ctrl. word | Control by using both digital input and control word. |
| [1] | Digital only | Control by using digital inputs only. |
| [2] | Control word only | Control by using control word only. |
| | | The setting in this parameter overrides the settings in par. 8-50 to 8-56. |
| 8-02 Control Word Source | | |
| Option: | | Function: |
| [0] | None | |
| [1] | FC RS-485 | |
| [2] | FC USB | |
| [3] | Option A | |
| [4] | Option B | |
| [5] | Option C0 | |
| [6] | Option C1 | |
| [30] | External Can | Select the source of the control word: one of two serial interfaces or four installed options. During initial power-up, the adjustable frequency drive automatically sets this parameter to <i>Option A</i> [3] if it detects a valid serial communication option installed in slot A. If the option is removed, the adjustable frequency drive detects a change in the configuration, sets par. 8-02 back to default setting <i>FC RS-485</i> , and the adjustable frequency drive then trips. If an option is installed after initial power-up, the setting of par. 8-02 will not change, but the adjustable frequency drive will trip and display: <i>Alarm 67 Option Changed</i> . This parameter cannot be adjusted while the motor is running. |

8-03 Control Word Timeout Time

Range:

1.0s* [0.1 - 18000.0 s]

Function:

Enter the maximum time expected to pass between the reception of two consecutive telegrams. If this time is exceeded, it indicates that the serial communication has stopped. The function selected in par. 8-04, *Control Word Timeout Function*, will then be carried out. The timeout counter is triggered by a valid control word.

8-04 Control Word Timeout Function

Option:
Function:

[0] * Off

[1] Freeze Output

[2] Stop

[3] Jogging

[4] Max. Speed

[5] Stop and trip

[7] Select set-up 1

[8] Select set-up 2

[9] Select set-up 3

[10] Select set-up 4

Select the timeout function. The timeout function activates when the control word fails to be updated within the time period specified in par. 8-03 *Control Word Timeout Time*.

- *Off* [0]: Resume control via serial bus (serial communication bus or standard) using the most recent control word.
- *Freeze output* [1]: Freeze output frequency until communication resumes.
- *Stop* [2]: Stop with auto-restart when communication resumes.
- *Jogging* [3]: Run the motor at JOG frequency until communication resumes.
- *Max. freq.* [4]: Run the motor at maximum frequency until communication resumes.
- *Stop and trip* [5]: Stop the motor, then reset the adjustable frequency drive in order to restart: via the serial communication bus, via the reset button on the LCP or via a digital input.
- *Select set-up 1-4* [7] - [10]: This option changes the set-up upon reestablishment of communication following a control word timeout. If communication resumes causing the timeout situation to disappear, par. 8-05, *End-of-timeout Function*, defines whether to resume the set-up used before the timeout or to retain the set-

up endorsed by the timeout function. Note the following configuration required in order to change the set-up after a timeout: Set Par. 0-10, *Active set-up*, to *Multi set-up* [9], and select the relevant link in par. 0-12, *This Set-up Linked To*.

8-05 End-of-Timeout Function

| | |
|-----------------|--|
| Option: | Function: |
| [0] Hold set-up | Retains the set-up selected in par. 8-04 and displays a warning, until par. 8-06 toggles. Then the adjustable frequency drive resumes its original set-up. |

| | |
|---------------------|---|
| [1] * Resume set-up | Resumes the set-up active prior to the timeout. |
|---------------------|---|

Select the action after receiving a valid control word following a timeout. This parameter is active only when par. 8-04 is set to [Set-up 1-4].

8-06 Reset Control Word Timeout

| | |
|--------------------|---|
| Option: | Function: |
| [0] * Do not reset | |
| [1] Do reset | Select <i>Do reset</i> [1] to return the adjustable frequency drive to the original set-up following a control word timeout. When the value is set to <i>Do reset</i> [1], the adjustable frequency drive performs the reset and then immediately reverts to the <i>Do not reset</i> [0] setting. |

Select *Do not reset* [0] to retain the set-up specified in par. 8-04, *Select set-up 1-4*, following a control word timeout. This parameter is active only when *Hold set-up* [0] has been selected in par. 8-05, *End-of-Timeout Function*.

8-07 Diagnosis Trigger

| | |
|--------------------------|--|
| Option: | Function: |
| [0] * Disable | |
| [1] Trigger on alarms | |
| [2] Trigger alarms/warn. | This parameter enables and controls the adjustable frequency drive diagnosis function and permits expansion of the diagnosis data to 24 bytes. |

NOTE
It relates only to Profibus.

- *Disable* [0]: Do not send extended diagnosis data even if they appear in the adjustable frequency drive.

- *Trigger on alarms* [1]: Send extended diagnosis data when one or more alarms appear in alarm par. 16-90 or 9-53.
- *Trigger alarms/warn.* [2]: Send extended diagnosis data if one or more alarms or warnings appear in alarm par. 16-90, 9-53, or warning par. 16-92.

The content of the extended diagnosis frame is as follows:

| Byte | Content | Description |
|---------|---------------------------|---------------------------------------|
| 0 - 5 | Standard DP Diagnose Data | Standard DP Diagnose Data |
| 6 | PDU length xx | Header of extended diagnostic data |
| 7 | Status type = 0x81 | Header of extended diagnostic data |
| 8 | Slot = 0 | Header of extended diagnostic data |
| 9 | Status info = 0 | Header of extended diagnostic data |
| 10 - 13 | VLT par. 16-92 | VLT warning word |
| 14 - 17 | VLT par. 16-03 | VLT status word |
| 18 - 21 | VLT par. 16-90 | VLT alarm word |
| 22 - 23 | VLT par. 9-53 | Communication warning word (Profibus) |

Enabling diagnosis may cause increased bus traffic. Diagnosis functions are not supported by all serial communication bus types.

2.11.3. 8-1* Ctrl. Word Settings

Parameters for configuring the option control word profile.

8-10 Control Word Profile

Option:

Function:

[0] * FC profile

[1] PROFIdrive profile

[5] ODVA

[7] CANopen DSP 402

Select the interpretation of the control and status words corresponding to the installed serial communication bus. Only the selections valid for the serial communication bus installed in slot A will be visible in the LCP display.

For guidelines for selecting the *FC profile* [0] and the *PROFIdrive profile* [1], refer to the *Serial communication via RS-485 Interface* section.

For additional guidelines in selecting the PROFIdrive profile [1], ODVA [5] and *CANopen DSP 402* [7], refer to the Instruction Manual for the installed serial communication bus.

8-13 Configurable Status Word STW

Option:

Function:

This parameter enables configuration of bit 12 – 15 in the status word.

| | | |
|-------|----------------------|--|
| [0] | No function | |
| [1] * | Profile default | Function corresponds to the profile default selected in par. 8-10. |
| [2] | Alarm 68 only | Only set in case of an Alarm 68. |
| [3] | Trip except Alarm 68 | Set in case of a trip, except if the trip is executed by an Alarm 68. |
| [16] | T37 DI status | The bit indicates the status of terminal 37. "0" indicates T37 is low (safe stop) "1" indicates T37 is high (normal) |

2.11.4. 8-3* FC Port Settings

Parameters for configuring the FC Port.

| 8-30 Protocol | |
|-----------------------------|--|
| Option: | Function: |
| [0] * FC | |
| [1] FC MC | Select the protocol for the FC (standard) port. |
| 8-31 Address | |
| Range: | Function: |
| 1* [1 - 126] | Enter the address for the FC (standard) port. Valid range: 1 - 126. |
| 8-32 FC Port Baud Rate | |
| Option: | Function: |
| [0] 2400 baud | |
| [1] 4800 baud | |
| [2] * 9600 baud | |
| [3] 19200 baud | |
| [4] 38400 baud | |
| [7] 115200 baud | Baud rate selection for the FC (standard) port. |
| 8-35 Minimum Response Delay | |
| Range: | Function: |
| 10ms* [1 - 500 ms] | Specify the minimum delay time between receiving a request and transmitting a response. This is used for overcoming modem turnaround delays. |

8-36 Max Response Delay

Range:

 5000 [1 - 10000 ms]
ms*

Function:

Specify the maximum permissible delay time between transmitting a request and receiving a response. Exceeding this delay time will cause control word timeout.

8-37 Max Inter-Char Delay

Range:

25 ms* [0 - 30 ms]

Function:

 Specify the maximum permissible time interval between receiving two bytes. This parameter activates timeout if transmission is interrupted.
This parameter is active only when par. 8-30 is set to *FC MC*[1] protocol.

8-40 FC MC Protocol Set

Option:

[1] * Standard Telegram 1

[200] Custom Telegram

Function:

Enables use of freely configurable telegrams or standard telegrams for the FC port.

2.11.5. 8-5* Digital/Bus

Parameters for configuring the control word Digital/Bus merging.

8-50 Coasting Select

Option:

[0] Digital input

[1] Bus

[2] Logic AND

[3] * Logic OR

Function:

Select control of the coasting function via the terminals (digital input) and/or via the bus.

NOTE

 This parameter is active only when par. 8-01, *Control Site*, is set to [0] *Digital* and *control word*.

8-51 Quick Stop Select

Option:

[0] Digital input

[1] Bus

[2] Logic AND

Function:

| | | |
|-------|----------|--|
| [3] * | Logic OR | Select control of the quick stop function via the terminals (digital input) and/or via the bus. |
| | |  <p>NOTE This parameter is active only when par. 8-01, <i>Control Site</i>, is set to [0] <i>Digital and control word</i>.</p> |

8-52 DC Brake Select

| Option: | Function: |
|-------------------|-----------|
| [0] Digital input | |
| [1] Bus | |
| [2] Logic AND | |
| [3] * Logic OR | |

Select control of the DC brake via the terminals (digital input) and/or via the serial communication bus.

| | |
|--|--|
|  | <p>NOTE This parameter is active only when par. 8-01, <i>Control Site</i>, is set to [0] <i>Digital and control word</i>.</p> |
|--|--|

8-53 Start Select

| Option: | Function: |
|-------------------|--|
| [0] Digital input | |
| [1] Bus | Activates the start command via the serial communication port or serial communication option. |
| [2] Logic AND | Activates the start command via the serial communication port, AND additionally via one of the digital inputs. |
| [3] * Logic OR | Activates the start command via the serial communication port OR via one of the digital inputs. |

Select control of the adjustable frequency drive start function via the terminals (digital input) and/or via the serial communication bus.

| | |
|---|--|
|  | <p>NOTE This parameter is active only when par. 8-01, <i>Control Site</i>, is set to [0] <i>Digital and control word</i>.</p> |
|---|--|

8-54 Reversing Select

Option:
Function:

[0] Digital input

[1] Bus

[2] Logic AND

[3] * Logic OR

Select control of the adjustable frequency drive reverse function via the terminals (digital input) and/or via the serial communication bus.

Select *Bus* [1], to activate the reverse command via the serial communication port or serial communication option.

Select *Logic AND* [2] to activate the reverse command via the serial communication bus/serial communication port, AND additionally via one of the digital inputs.

Select *Logic OR* [3] to activate the reverse command via the serial communication bus/serial communication port OR via one of the digital inputs.

NOTE

This parameter is active only when par. 8-01, *Control Site*, is set to [0] *Digital and control word*.

8-55 Set-up Select

Option:
Function:

[0] Digital input

[1] Bus

Activates the set-up selection via the serial communication port or serial communication option.

[2] Logic AND

Activates the set-up selection via the serial communication port, AND additionally via one of the digital inputs.

[3] * Logic OR

Activate the set-up selection via the serial communication port OR via one of the digital inputs.

Select control of the adjustable frequency drive set-up selection via the terminals (digital input) and/or via the serial communication bus.

NOTE

This parameter is active only when par. 8-01, *Control Site*, is set to [0] *Digital and control word*.

8-56 Preset Reference Select

| Option: | Function: |
|-------------------|---|
| [0] Digital input | |
| [1] Bus | Activates the Preset Reference selection via the serial communication port or serial communication option. |
| [2] Logic AND | Activates the Preset Reference selection via the serial communication port, AND additionally via one of the digital inputs. |
| [3] * Logic OR | Activates the Preset Reference selection via the serial communication port OR via one of the digital inputs. |

Select control of the adjustable frequency drive Preset Reference selection via the terminals (digital input) and/or via the serial communication bus.



NOTE

This parameter is active only when par. 8-01, *Control Site*, is set to [0] *Digital* and *control word*.

2.11.6. 8-9* Bus Jog

Parameters for configuring the bus jog.

8-90 Bus Jog 1 Speed

| Range: | Function: |
|------------------------------|--|
| 100 [0 - par. 4-13 rpm] rpm* | Enter the jog speed. This is a fixed jog speed activated via the serial port or serial communication option. |

8-91 Bus Jog 2 Speed

| Range: | Function: |
|------------------------------|--|
| 200 [0 - par. 4-13 rpm] rpm* | Enter the jog speed. This is a fixed jog speed activated via the serial port or serial communication option. |

2.12. Parameters: Profibus

2

2.12.1. 9-** Profibus

Parameter group for all Profibus-specific parameters.

9-00 Setpoint

Range:

0* [0-65535]

Function:

This parameter receives cyclical reference from a Master Class 2. If the control priority is set to Master Class 2, the reference for the adjustable frequency drive is taken from this parameter, whereas the cyclical reference will be ignored.

9-07 Actual Value

Range:

0* [0-65535]

Function:

This parameter delivers the MAV for a Master Class 2. The parameter is valid if the control priority is set to Master Class 2.

9-15 PCD Write Configuration

Array [10]

None

3-02 Minimum Reference

3-03 Maximum Reference

3-12 Catch Up/Slow-down Value

3-41 Ramp 1 Ramp-up Time

3-42 Ramp 1 Ramp-down Time

3-51 Ramp 2 Ramp-up Time

3-52 Ramp 2 Ramp-down Time

3-80 Jog Ramp Time

3-81 Quick Stop Ramp Time

4-11 Motor Speed Low Limit [RPM]

4-13 Motor Speed High Limit [RPM]

| | |
|----------------------------------|---|
| 4-16 Torque Limit Motor Mode | |
| 4-17 Torque Limit Generator Mode | |
| 7-28 Minimum Feedback | |
| 7-29 Maximum Feedback | |
| 8-90 Bus Jog 1 Speed | |
| 8-91 Bus Jog 2 Speed | |
| 16-80 Ser. Com. Bus CTW 1 | |
| 16-82 Ser. Com. Bus REF 1 | |
| 34-01 PCD 1 Write to MCO | |
| 34-02 PCD 2 Write to MCO | |
| 34-03 PCD 3 Write to MCO | |
| 34-04 PCD 4 Write to MCO | |
| 34-05 PCD 5 Write to MCO | |
| 34-06 PCD 6 Write to MCO | |
| 34-07 PCD 7 Write to MCO | |
| 34-08 PCD 8 Write to MCO | |
| 34-09 PCD 9 Write to MCO | |
| 34-10 PCD 10 Write to MCO | Select the parameters to be assigned to PCD 3 to 10 of the telegrams. The number of available PCDs depends on the telegram type. The values in PCDs 3 to 10 will then be written to the selected parameters as data values. Alternatively, specify a standard Profibus telegram in par. 9-22. |

9-16 PCD Read Configuration

| |
|--------------------|
| Array [10] |
| None |
| 16-00 Control Word |

16-01 Reference
[Unit]

16-02 Reference %

16-03 Status Word

16-04 Main Actual
Value [Unit]

16-05 Main Actual
Value [%]

16-09 Custom Read-
out

16-10 Power [kW]

16-11 Power [HP]

16-12 Motor Voltage

16-13 Frequency

16-14 Motor Current

16-16 Torque

16-17 Speed [rpm]

16-18 Motor Thermal

16-19 KTY Sensor
Temperature

16-21 Phase Angle

16-30 DC Link Voltage

16-32 Brake Energy /
s

16-33 Brake Energy /
2 min 16-34 Heatsink
Temp.

16-35 Inverter Ther-
mal

16-38 SL Control
State

16-39 Control Card
Temp.

16-50 External Refer-
ence

16-51 Pulse Refer-
ence

16-52 Feedback
[Unit]

16-53 DigiPot Refer-
ence

16-60 Digital Input

16-61 Terminal 53
Switch Setting

| | |
|-------------------------------|---------------|
| 16-62 Analog Input | 53 |
| 16-63 Terminal Switch Setting | 54 |
| 16-64 Analog Input | 54 |
| 16-65 Analog Output | 42 [mA] |
| 16-66 Digital Output | [bin] |
| 16-67 Freq. Input | #29 [Hz] |
| 16-68 Freq. Input | #33 [Hz] |
| 16-69 Pulse Output | #27 [Hz] |
| 16-70 Pulse Output | #29 [Hz] |
| 16-71 Pulse Output | [bin] |
| 16-84 Comm Option | STW [Binary] |
| 16-85 FC port CTW 1 | Signal |
| 16-90 Alarm Word | |
| 16-91 Alarm Word 2 | |
| 16-92 Warning Word | |
| 16-93 Warning Word | 2 |
| 16-94 Extended Status Word | |
| 16-95 Extended Status Word 2 | |
| 34-21 PCD 1 | Read from MCO |
| 34-22 PCD 2 | Read from MCO |
| 34-23 PCD 3 | Read from MCO |
| 34-24 PCD 4 | Read from MCO |
| 34-25 PCD 5 | Read from MCO |
| 34-26 PCD 6 | Read from MCO |

34-27 PCD 7 Read
from MCO

34-28 PCD 8 Read
from MCO

34-29 PCD 9 Read
from MCO

34-30 PCD 10 Read
from MCO

34-40 Digital Inputs

34-41 Digital Outputs

34-50 Actual Position

34-51 Commanded
Position

34-52 Actual Master
Position

34-53 Slave Index Po-
sition

34-54 Master Index
Position

34-55 Curve Position

34-56 Track Error

34-57 Synchronizing
Error

34-58 Actual Velocity

34-59 Actual Master
Velocity

34-60 Synchroniza-
tion Status

34-61 Axis Status

34-62 Program Status Select the parameters to be assigned to PCDs 3 to 10 of the telegrams. The number of available PCDs depends on the telegram type. PCDs 3 to 10 contain the actual data values of the selected parameters. For standard Profibus telegrams, see par. 9-22.

9-18 Node Address

Range:

126* [0 - 126]

Function:

Enter the station address in this parameter, or alternatively in the hardware switch. In order to adjust the station address in par. 9-18, the hardware switch must be set to 126 or 127 (i.e., all switches set to 'on'). Otherwise, this parameter will display the actual setting of the switch.

9-22 Telegram Selection

| Option: | Function: |
|-------------------------|---|
| [1] Standard telegram 1 | |
| [101] PPO 1 | |
| [102] PPO 2 | |
| [103] PPO 3 | |
| [104] PPO 4 | |
| [105] PPO 5 | |
| [106] PPO 6 | |
| [107] PPO 7 | |
| [108] * PPO 8 | Read only. Displays the Profibus telegram configuration. |

9-23 Parameters for Signals

Array [1000]
Read only

This parameter contains a list of signals available for selection in par. 9-15 and 9-16.

9-27 Parameter Edit

| Option: | Function: |
|---------------|---|
| [0] Disabled | Parameters can be edited via Profibus, the standard RS-485 interface, or the LCP. |
| [1] * Enabled | Disables editing via Profibus. |
| | Enables editing via Profibus. |

9-28 Process Control

| Option: | Function: |
|-------------|---|
| [0] Disable | Process control (setting of control word, speed reference and process data) is possible via either Profibus or standard serial communication bus, but not both simultaneously. Local control is always possible via the LCP. Control via process control is possible via either terminals or serial communication bus depending on the settings in par. 8-50 to 8-56. |
| | Disables process control via Profibus, and enables process control via standard serial communication bus or Profibus Master class 2. |

[1] * Enable cyclic master Enables process control via Profibus Master Class 1, and disables process control via standard serial communication bus or Profibus Master class 2.

9-44 Fault Message Counter

Range:
0* [0-65535]

Function:
This parameter displays the number of error events stored in par. 9-45 and 9-47. The maximum buffer capacity is eight error events. The buffer and counter are set to 0 upon reset or power-up.

9-45 Fault Code

Range:
0* [0 - 0]

Function:
This buffer contains the alarm word for all alarms and warnings that have occurred since the last reset or power-up. The maximum buffer capacity is eight error events.

9-47 Fault Number

Range:
0* [0 - 0]

Function:
This buffer contains the alarm number (2 for live zero error, 4 for line phase loss, e.g.) for all alarms and warnings that have occurred since the last reset or power-up. The maximum buffer capacity is eight error events.

9-52 Fault Situation Counter

Range:
0* [0 - 1000]

Function:
This parameter displays the number of error events which have occurred since the last reset of power-up.

9-53 Profibus Warning Word

Option:

Function:
This parameter displays Profibus communication warnings. Please refer to the *Profibus Instruction Manual* for further information.

Read only

| Bit: | Meaning: |
|------|---|
| 0 | Connection with DP master is not |
| 1 | Not used |
| 2 | FDL (Fieldbus [or Serial Communication Bus] Link Layer) is not ok |
| 3 | Clear data command received |
| 4 | Actual value is not updated |
| 5 | Baudrate search |
| 6 | PROFIBUS ASIC is not transmitting |
| 7 | Initializing of PROFIBUS is not ok |
| 8 | Drive is tripped |
| 9 | Internal CAN error |
| 10 | Wrong configuration data from PLC |
| 11 | Wrong ID sent by PLC |
| 12 | Internal error occurred |
| 13 | Not configured |
| 14 | Timeout active |
| 15 | Warning 34 active |

9-63 Actual Baud Rate

Option:

Function:

This parameter displays the actual Profibus baud rate. The Profibus Master automatically sets the baud rate.

| | Read only |
|-------|--------------------|
| [0] | 9.6 kbit/s |
| [1] | 19.2 kbit/s |
| [2] | 93.75 kbit/s |
| [3] | 187.5 kbit/s |
| [4] | 500 kbit/s |
| [6] | 1,500 kbit/s |
| [7] | 3,000 kbit/s |
| [8] | 6,000 kbit/s |
| [9] | 12,000 kbit/s |
| [10] | 31.25 kbit/s |
| [11] | 45.45 kbit/s |
| [255] | No baud rate found |

9-64 Device Identification

Range:

Function:

0* [0 - 0]

This parameter displays the device identification. Please refer to the *Instruction Manual for Profibus, MG33CXYT* for further explanation.

9-65 Profile Number

Range:

Function:

Read only

0* [0 - 0]

This parameter contains the profile identification. Byte 1 contains the profile number, and byte 2 the version number of the profile.

**NOTE**

This parameter is not visible via LCP.

9-67 Control Word 1**Range:**

0* [0-65535]

Function:

This parameter accepts the control word from a Master Class 2 in the same format as PCD 1.

9-68 Status Word 1**Range:**

0* [0-65535]

Function:

This parameter delivers the status word for a Master Class 2 in the same format as PCD 2.

9-70 Edit Set-up**Option:****Function:**

Select the set-up to be edited.

| | | |
|-------|----------------|---|
| [0] | Factory set-up | Uses default data. This option can be used as a data source to return the other set-ups to a known state. |
| [1] * | Set-up 1 | Edits Set-up 1. |
| [2] | Set-up 2 | Edits Set-up 2. |
| [3] | Set-up 3 | Edits Set-up 3. |
| [4] | Set-up 4 | Edits Set-up 4. |
| [9] | Active set-up | Follows the active set-up selected in par. 0-10. |

This parameter is unique to LCP and serial communication buses. See also par. 0-11 *Edit set-up*.

9-71 Save Data Values**Option:****Function:**

Parameter values changed via Profibus are not automatically stored in non-volatile memory. Use this parameter to activate a function that stores parameter values in the EEPROM non-volatile memory, so that changed parameter values will be retained at power-down.

| | | |
|-------|-------------------|--|
| [0] * | Off | Deactivates the non-volatile storage function. |
| [1] | Store edit set-up | Stores all parameter values in the set-up selected in par. 9-70 in the non-volatile memory. The selection returns to Off [0] when all values have been stored. |

| | | |
|-----|-------------------|---|
| [2] | Store all set-ups | Stores all parameter values for all set-ups in the non-volatile memory. The selection returns to <i>Off</i> [0] when all parameter values have been stored. |
|-----|-------------------|---|

9-72 Drive Reset

| Option: | | Function: |
|----------------|--------------------|--|
| [0] * | No action | |
| [1] | Power-on reset | Resets the adjustable frequency drive upon power-up, as for power-cycle. |
| [3] | Comm. option reset | Resets the Profibus option only, useful after changing certain settings in parameter group 9-**, in par. 9-18 for example. When reset, the adjustable frequency drive disappears from the serial communication bus, which may cause a communication error from the master. |

9-80 Defined Parameters (1)

Array [116]

No LCP access

Read only

| | | |
|----|-----------|---|
| 0* | [0 - 115] | This parameter displays a list of all the defined adjustable frequency drive parameters available for Profibus. |
|----|-----------|---|

9-81 Defined Parameters (2)

Array [116]

No LCP access

Read only

| | | |
|----|-----------|---|
| 0* | [0 - 115] | This parameter displays a list of all the defined adjustable frequency drive parameters available for Profibus. |
|----|-----------|---|

9-82 Defined Parameters (3)

Array [116]

No LCP access

2

Read only

0* [0 - 115] This parameter displays a list of all the defined adjustable frequency drive parameters available for Profibus.

9-83 Defined Parameters (4)

Array [116]

No LCP access

Read only

0* [0 - 115] This parameter displays a list of all the defined adjustable frequency drive parameters available for Profibus.

9-84 Defined Parameters (5)

Range: **Function:**

Array [116]

No LCP access

Read only

0* [0 - 115] This parameter displays a list of all the defined adjustable frequency drive parameters available for Profibus.

9-90 Changed Parameters (1)

Array [116]

No LCP access

Read only

0* [0 - 115] This parameter displays a list of all the adjustable frequency drive parameters deviating from default setting.

9-91 Changed Parameters (2)

Array [116]

No LCP access

Read only

0* [0 - 115] This parameter displays a list of all the adjustable frequency drive parameters deviating from default setting.

9-92 Changed Parameters (3)

Array [116]

No LCP access

Read only

0* [0 - 115] This parameter displays a list of all the adjustable frequency drive parameters deviating from default setting.

9-94 Changed Parameters (5)

Array [116]

No LCP access

Read only

0* [0 - 115] This parameter displays a list of all the adjustable frequency drive parameters deviating from default setting.

2.13. Parameters: DeviceNet CAN Serial Communication Bus

2

2.13.1. 10-** DeviceNet and CAN Serial Communication Bus

Parameter group for DeviceNet CAN serial communication bus parameters.

2.13.2. 10-0* Common Settings

Parameter group for configuring common settings for CAN serial communication options.

10-00 CAN Protocol

Option: **Function:**

[0] CANopen

[1] * DeviceNet

View the active CAN protocol.



NOTE

The options depend on installed option.

10-01 Baud Rate Select

Option: **Function:**

[16] 10 Kbps

[17] 20 Kbps

[18] 50 Kbps

[19] 100 Kbps

[20] * 125 Kbps

[21] 250 Kbps

[22] 500 Kbps

Select the serial communication bus transmission speed. The selection must correspond to the transmission speed of the master and the other serial communication bus nodes.

10-02 MAC ID

Range: **Function:**

63* [0 - 127]

Selection of station address. Every station connected to the same network must have an unambiguous address.

10-05 Readout Transmit Error Counter

Range: **Function:**

0* [0 - 255]

View the number of CAN control transmission errors since the last power-up.

10-06 Readout Receive Error Counter

| | |
|----------------|--|
| Option: | Function: |
| [0] 0 - 255 | View the number of CAN control receipt errors since the last power-up. |

10-07 Readout Bus Off Counter

| | |
|---------------|--|
| Range: | Function: |
| 0* [0 - 255] | View the number of Bus Off events since the last power-up. |

2.13.3. 10-1* DeviceNet

Parameters specific to the DeviceNet serial communication bus.

10-10 Process Data Type Selection

| | |
|----------------|--|
| Option: | Function: |
| | Select the instance (telegram) for data transmission. The instances available are dependent upon the setting of par. 8-10 <i>Control Word Profile</i> . When par. 8-10 is set to [0] <i>FC profile</i> , par. 10-10 options [0] and [1] are available. When par. 8-10 is set to [5] <i>ODVA</i> , par. 10-10 options [2] and [3] are available. Instances 100/150 and 101/151 are Danfoss-specific. Instances 20/70 and 21/71 are ODVA-specific AC drive profiles. For guidelines in telegram selection, please refer to the DeviceNet Instruction Manual. Note that a change to this parameter will be executed immediately. |

- [0] Instance 100/150
- [1] Instance 101/151
- [2] Instance 20/70
- [3] Instance 21/71

10-11 Process Data Config Write

| | |
|----------------|-------------------------------|
| Option: | Function: |
| [0] * None | |
| | 3-02 Minimum reference |
| | 3-03 Maximum Reference |
| | 3-12 Catch up/slow-down value |
| | 3-41 Ramp 1 ramp-up time |

2

3-42 Ramp 1 Ramp-down Time

3-51 Ramp 2 Ramp-up Time

3-52 Ramp 2 Ramp-down Time

3-80 Jog ramp time

3-81 Quick stop ramp time

4-11 Motor speed low limit (rpm)

4-13 Motor speed high limit (rpm)

4-16 Torque limit motor mode

4-17 Torque limit generator mode

7-28 Minimum Feedback

7-29 Maximum Feedback

8-90 Bus Jog 1 Speed

8-91 Bus Jog 2 Speed

16-80 Ser. Com. Bus CTW 1 (Fixed)

16-82 Ser. Com. Bus REF 1 (Fixed)

34-01 PCD 1 Write to MCO

34-02 PCD 2 Write to MCO

34-03 PCD 3 Write to MCO

34-04 PCD 4 Write to MCO

34-05 PCD 5 Write to MCO

34-06 PCD 6 Write to MCO

34-07 PCD 7 Write to MCO

34-08 PCD 8 Write to MCO

34-09 PCD 9 Write to MCO

34-10 PCD 10 Write to MCO Select the process write data for I/O assembly instances 101/151. Elements [2] and [3] of this array can be selected. Elements [0] and [1] of the array are fixed.

10-12 Process Data Config Read

| Option: | Function: |
|---------|-------------------------------|
| None | |
| 16-00 | Control Word |
| 16-01 | Reference [Unit] |
| 16-02 | Reference % |
| 16-03 | Status Word (Fixed) |
| 16-04 | Main Actual Value [Unit] |
| 16-05 | Main Actual Value [%] (Fixed) |
| 16-10 | Power [kW] |
| 16-11 | Power [HP] |
| 16-12 | Motor Voltage |
| 16-13 | Frequency |
| 16-14 | Motor Current |
| 16-16 | Torque |
| 16-17 | Speed [rpm] |
| 16-18 | Motor Thermal |
| 16-19 | KTY Sensor Temperature |
| 16-21 | Phase Angle |
| 16-30 | DC Link Voltage |
| 16-32 | BrakeEnergy/s |
| 16-33 | BrakeEnergy/2 min |
| 16-34 | Heatsink Temp. |
| 16-35 | Inverter Thermal |
| 16-38 | SL Control State |
| 16-39 | Control Card Temp. |
| 16-50 | External Reference |
| 16-51 | Pulse Reference |

2

16-52 Feedback
[Unit]

16-53 DigiPot Reference

16-60 Digital Input

16-61 Terminal 53
Switch Setting

16-62 Analog Input
53

16-63 Terminal 54
Switch Setting

16-64 Analog Input
54

16-65 Analog Output
42 [mA]

16-66 Digital Output
[bin]

16-67 Freq. Input
#29 [Hz]

16-68 Freq. Input
#33 [Hz]

16-69 Pulse Output
#27 [Hz]

16-70 Pulse Output
#29 [Hz]

16-71 Relay Output
[bin]

16-84 Comm Option
STW

16-85 FC Port CTW 1

16-90 Alarm Word

16-91 Alarm Word 2

16-92 Warning Word

16-93 Warning Word
2

16-94 Extended Status
Word

16-95 Extended Status
Word 2

34-21 PCD 1 Read
from MCO

34-22 PCD 2 Read
from MCO

34-23 PCD 3 Read
from MCO

| | | |
|-------|------------------------|---|
| 34-24 | PCD 4 | Read from MCO |
| 34-25 | PCD 5 | Read from MCO |
| 34-26 | PCD 6 | Read from MCO |
| 34-27 | PCD 7 | Read from MCO |
| 34-28 | PCD 8 | Read from MCO |
| 34-29 | PCD 9 | Read from MCO |
| 34-30 | PCD 10 | Read from MCO |
| 34-40 | Digital Inputs | |
| 34-41 | Digital Outputs | |
| 34-50 | Actual Position | |
| 34-51 | Commanded Position | |
| 34-52 | Actual Master Position | |
| 34-53 | Slave Index Position | |
| 34-54 | Master Index Position | |
| 34-55 | Curve Position | |
| 34-56 | Track Error | |
| 34-57 | Synchronizing Error | |
| 34-58 | Actual Velocity | |
| 34-59 | Actual Master Velocity | |
| 34-60 | Synchronizing Status | |
| 34-61 | Axis Status | |
| 34-62 | Program Status | Select the process read data for I/O assembly instances 101/151. Elements [2] and [3] of this array can be selected. Elements [0] and [1] of the array are fixed. |

10-13 Warning Parameter

| | |
|---------------|---|
| Range: | Function: |
| 0* [0 - FFFF] | View a DeviceNet-specific warning word. One bit is assigned to every warning. Please refer to the DeviceNet Instruction Manual (MG.33.DX.YY) for further information. |

| Bit: | Meaning: |
|------|-----------------------------|
| 0 | Bus not active |
| 1 | Explicit connection timeout |
| 2 | I/O connection |
| 3 | Retry limit reached |
| 4 | Actual is not updated |
| 5 | CAN bus off |
| 6 | I/O send error |
| 7 | Initialization error |
| 8 | No bus supply |
| 9 | Bus off |
| 10 | Error passive |
| 11 | Error warning |
| 12 | Duplicate MAC ID Error |
| 13 | RX queue overrun |
| 14 | TX queue overrun |
| 15 | CAN overrun |

10-14 Net Reference

Read only from LCP.

Select the reference source in instance 21/71 and 20/70.

[0] * Off Enables reference via analog/digital inputs.

[1] On Enables reference via the serial communication bus.

10-15 Net Control

Read only from LCP.

Select the control source in instance 21/71 and 20-70.

[0] * Off Enables control via analog/digital inputs.

[1] On enable control via the serial communication bus.

2.13.4. 10-2* COS Filters

Parameters for configuring COS filter settings.

10-20 COS Filter 1

Range:

0000* [0 - FFFF]

Function:

Enter the value for COS Filter 1 to set up the filter mask for the status word. When operating in COS (change-of-state), this function filters out bits in the status word that should not be sent if they change.

10-21 COS Filter 2

| | |
|-----------------------------------|--|
| Range: 0000* [0 - FFFF] | Function: Enter the value for COS Filter 2 to set up the filter mask for the main actual value. When operating in COS (change-of-state), this function filters out bits in the main actual value that should not be sent if they change. |
|-----------------------------------|--|

10-22 COS Filter 3

| | |
|-----------------------------------|---|
| Range: 0000* [0 - FFFF] | Function: Enter the value for COS Filter 3 in order to set up the filter mask for PCD 3. When operating in COS (change-of-state), this function filters out bits in PCD 3 that should not be sent if they change. |
|-----------------------------------|---|

10-23 COS Filter 4

| | |
|-----------------------------------|--|
| Range: 0000* [0 - FFFF] | Function: Enter the value for COS Filter 4 to set up the filter mask for PCD 4. When operating in COS (change-of-state), this function filters out bits in PCD 4 that should not be sent if they change. |
|-----------------------------------|--|

2.13.5. 10-3* Parameter Access

Parameter group providing access to indexed parameters and defining programming set-up.

10-30 Array Index

| | |
|-------------------------------|---|
| Range: 0* [0 - 255] | Function: View array parameters. This parameter is valid only when a DeviceNet serial communication bus is installed. |
|-------------------------------|---|

10-31 Store Data Values

| | |
|-----------------------|--|
| Option: | Function: Parameter values changed via DeviceNet are not automatically stored in non-volatile memory. Use this parameter to activate a function that stores parameter values in the EEPROM non-volatile memory, so that changed parameter values will be retained at power-down. |
| [0] * Off | Deactivates the non-volatile storage function. |
| [1] Store edit set-up | Stores all parameter values from the active set-up in the non-volatile memory. The selection returns to Off [0] when all values have been stored. |

2

| | | |
|-----|-------------------|--|
| [2] | Store all set-ups | store all parameter values for all set-ups in the non-volatile memory. The selection returns to <i>Off</i> [0] when all parameter values have been stored. |
|-----|-------------------|--|

10-32 DeviceNet Revision**Option:****Function:**

Major revision

Minor revision

View the DeviceNet revision number. This parameter is used for EDS file creation.

10-33 Store Always**Option:****Function:**

[0] * Off

Deactivates non-volatile storage of data.

[1] On

Stores parameter data received via DeviceNet in EEPROM non-volatile memory as default.

10-39 DeviceNet F Parameters

Array [1000]

No LCP access

0* [0 - 0]

This parameter is used to configure the adjustable frequency drive via DeviceNet and build the EDS file.

2.14. Parameters: Smart Logic Control

2.14.1. 13-** Prog. Features

Smart Logic Control (SLC) is essentially a sequence of user-defined actions (see par. 13-52 [x]) executed by the SLC when the associated user-defined *event* (see par. 13-51 [x]) is evaluated as TRUE by the SLC. Events and *actions* are each numbered and linked together in pairs (states). This means that when *event* [0] is fulfilled (attains the value TRUE), *action* [0] is executed. After this, the conditions of *event* [1] will be evaluated, and if evaluated as TRUE, *action* [1] will be executed and so on. Only one *event* will be evaluated at any time. If an *event* is evaluated as FALSE, nothing happens (in the SLC) during the current scan interval, and no other *events* will be evaluated. This means that when the SLC starts, it evaluates *event* [0] (and only *event* [0]) at each scan interval. Only when *event* [0] is evaluated as TRUE will the SLC execute *action* [0] and start evaluating *event* [1]. It is possible to program from 1 to 20 *events* and *actions*. When the last *event/action* has been executed, the sequence starts over again from *event* [0]/*action* [0]. When the last event/action has been executed, the sequence starts over again from event [0]/action [0].

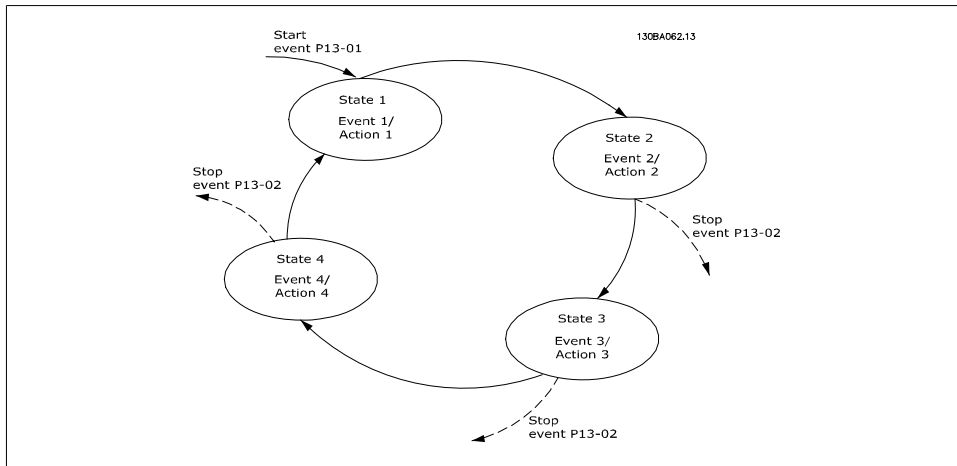

Starting and stopping the SLC:

Starting and stopping the SLC can be done by selecting On [1] or Off [0] in par. 13-00. The SLC always starts in state 0 (where it evaluates *event* [0]). The SLC starts when the start event (defined in par. 13-01 *Start Event*) is evaluated as TRUE (provided that *On* [1] is selected in par. 13-00). The SLC stops when the *Stop Event* (par. 13-02) is TRUE. Par. 13-03 resets all SLC parameters and starts programming from scratch.

2.14.2. 13-0* SLC Settings

Use the SLC settings to activate, deactivate and reset the smart logic control.

13-00 SL Controller Mode

| Option: | Function: |
|-----------|--------------------------------------|
| [0] * Off | Disables the smart logic controller. |
| [1] On | Enables the smart logic controller. |

13-01 Start Event

| Option: | Function: |
|---------------------------------------|-----------|
| [0] False | |
| [1] True | |
| [2] Running | |
| [3] In range | |
| [4] On reference | |
| [5] Torque limit | |
| [6] Current limit | |
| [7] Out of current range | |
| [8] Below I low | |
| [9] Above I high | |
| [10] Out of speed range | |
| [11] Below speed low | |
| [12] Above speed high | |
| [13] Out of feedb. range | |
| [14] Below feedb. low | |
| [15] Above feedb. high | |
| [16] Thermal warning | |
| [17] Line pwr out of range | |
| [18] Reversing | |
| [19] Warning | |
| [20] Alarm (trip) | |
| [21] Alarm (trip lock) | |
| [22] Comparator 0 | |
| [23] Comparator 1 | |
| [24] Comparator 2 | |
| [25] Comparator 3 | |
| [26] Logic rule 0 | |
| [27] Logic rule 1 | |
| [28] Logic rule 2 | |
| [29] Logic rule 3 | |
| [33] Digital input DI18 | |
| [34] Digital input DI19 | |
| [35] Digital input DI27 | |
| [36] Digital input DI29 (FC 302 only) | |

| | | |
|--------|--------------------|---|
| [37] | Digital input DI32 | |
| [38] | Digital input DI33 | |
| [39] * | Start command | |
| [40] | Drive stopped | |
| [41] | Reset Trip | |
| [42] | Auto-reset Trip | |
| [43] | OK key | |
| [44] | Reset key | |
| [45] | Left key | |
| [46] | Right key | |
| [47] | Up key | |
| [48] | Down key | |
| [50] | Comparator 4 | |
| [51] | Comparator 5 | |
| [60] | Logic rule 4 | |
| [61] | Logic rule 5 | <p>Select the Boolean (TRUE or FALSE) input to activate smart logic control.</p> <p><i>False</i> [0]: enters the fixed value - FALSE.</p> <p><i>True</i> [1]: enters the fixed value - TRUE.</p> <p><i>Running</i> [2]: motor is running.</p> <p><i>In range</i> [3]: motor is running within the programmed current and speed ranges set in par. 4-50 to par. 4-53.</p> <p><i>On reference</i> [4]: motor is running on reference.</p> <p><i>Torque limit</i> [5]: torque limit (set in par. 4-16 or 4-17) has been exceeded.</p> <p><i>Current limit</i> [6]: motor current limit (set in par. 4-18) has been exceeded.</p> <p><i>Out of current range</i> [7]: the motor current is outside the range set in par. 4-18.</p> <p><i>Below I low</i> [8]: the motor current is lower than set in par. 4-50.</p> <p><i>Above I high</i> [9]: the motor current is higher than set in par. 4-51.</p> <p><i>Out of speed range</i> [10]: the speed is outside the range set in par. 4-52 and 4-53.</p> <p><i>Below speed low</i> [11]: the output speed is lower than the setting in par. 4-52.</p> <p><i>Above speed high</i> [12]: the output speed is higher than the setting in par. 4-53.</p> <p><i>Out of feedb. Range</i> [13]: the feedback is outside the range set in par. 4-56 and 4-57.</p> <p><i>Below feedb. Low</i> [14]: the feedback is below the limit set in par. 4-56.</p> <p><i>Above feedb. High</i> [15]: the feedback is above the limit set in par. 4-57.</p> <p><i>Thermal warning</i> [16]: the thermal warning turns on when the temperature exceeds the limit in the motor, the adjustable frequency drive, the brake resistor or the thermistor.</p> |

Line voltage out of range [17]: the line voltage is outside the specified voltage range.

Reversing [18]: the output is high when the drive is running counter-clockwise (the logical product of the status bits "running" AND "reverse").

Warning [19]: a warning is active.

Alarm (trip) [20]: a (trip) alarm is active.

Alarm (trip lock) [21]: a (trip lock) alarm is active.

Comparator 0 [22]: use the result of comparator 0.

Comparator 1 [23]: use the result of comparator 1.

Comparator 2 [24]: use the result of comparator 2.

Comparator 3 [25]: use the result of comparator 3.

Logic rule 0 [26]: use the result of logic rule 0.

Logic rule 1 [27]: use the result of logic rule 1.

Logic rule 2 [28]: use the result of logic rule 2.

Logic rule 3 [29]: use the result of logic rule 3.

Digital input DI18 [33]: use the result of digital input 18.

Digital input DI19 [34]: use the result of digital input 19.

Digital input DI27 [35]: use the result of digital input 27.

Digital input DI29 FC302 Only [36]: use the result of digital input 29.

Digital input DI32 [37]: use the result of digital input 32.

Digital input DI33 [38]: use the result of digital input 33.

Start command [39]: a start command is issued.

Drive stopped [40]: a stop command (Jog, Stop, Qstop, Coast) is issued – and not from the SLC itself.

Reset Trip [41]: a reset is issued.

Auto-reset Trip [42]: an auto reset is performed.

OK key [43]: the Ok key is pressed.

Reset key [44]: the reset key is pressed.

Left key [45]: the left key is pressed.

Right key [46]: the right key is pressed.

Up key [47]: the up key is pressed.

Down key [48]: the down key is pressed.

Comparator 4 [50]: use the result of comparator 4.

Comparator 5 [51]: use the result of comparator 5.

Logic rule 4 [60]: use the result of logic rule 4.

Logic rule 5 [61]: use the result of logic rule 5.

13-02 Stop Event

Option:
Function:

| | |
|-----|----------------------|
| [0] | False |
| [1] | True |
| [2] | Running |
| [3] | In range |
| [4] | On reference |
| [5] | Torque limit |
| [6] | Current limit |
| [7] | Out of current range |

| | |
|------|----------------------------------|
| [8] | Below I low |
| [9] | Above I high |
| [10] | Out of speed range |
| [11] | Below speed low |
| [12] | Above speed high |
| [13] | Out of feedb. range |
| [14] | Below feedb. low |
| [15] | Above feedb. high |
| [16] | Thermal warning |
| [17] | Line pwr out of range |
| [18] | Reversing |
| [19] | Warning |
| [20] | Alarm (trip) |
| [21] | Alarm (trip lock) |
| [22] | Comparator 0 |
| [23] | Comparator 1 |
| [24] | Comparator 2 |
| [25] | Comparator 3 |
| [26] | Logic rule 0 |
| [27] | Logic rule 1 |
| [28] | Logic rule 2 |
| [29] | Logic rule 3 |
| [30] | SL Timeout 0 |
| [31] | SL Timeout 1 |
| [32] | SL Timeout 2 |
| [33] | Digital input DI18 |
| [34] | Digital input DI19 |
| [35] | Digital input DI27 |
| [36] | Digital input DI29 (FC 302 only) |
| [37] | Digital input DI32 |
| [38] | Digital input DI33 |
| [39] | Start command |
| [40] | Drive stopped |
| [41] | Reset Trip |
| [42] | Auto-reset Trip |
| [43] | OK key |
| [44] | Reset key |
| [45] | Left key |
| [46] | Right key |
| [47] | Up key |
| [48] | Down key |

2

| | | |
|------|--------------|---|
| [50] | Comparator 4 | |
| [51] | Comparator 5 | |
| [60] | Logic rule 4 | |
| [61] | Logic rule 5 | |
| [70] | SL Timeout 3 | |
| [71] | SL Timeout 4 | |
| [72] | SL Timeout 5 | |
| [73] | SL Timeout 6 | |
| [74] | SL Timeout 7 | Select the Boolean (TRUE or FALSE) input to activate smart logic control. For descriptions [0] - [61], see 13-01 <i>Start Event</i> <i>SL Timeout 3</i> [70] Smart logic controller timer 3 is timed out. <i>SL Timeout 4</i> [71] Smart logic controller timer 4 is timed out. <i>SL Timeout 5</i> [72] Smart logic controller timer 5 is timed out. <i>SL Timeout 6</i> [73] Smart logic controller timer 6 is timed out. <i>SL Timeout 7</i> [74] Smart logic controller timer 7 is timed out. |

13-03 Reset SLC

| Option: | Function: |
|------------------------|--|
| [0] * Do not reset SLC | Retains programmed settings in all group 13 parameters (13-*). |
| [1] Reset SLC | Resets all group 13 parameters (13-*) to default settings. |

2.14.3. 13-1* Comparators

Comparators are used for comparing continuous variables (i.e., output frequency, output current, analog input, etc.) to fixed preset values. In addition, there are digital values that will be compared to fixed time values. See explanation in par. 13-10. Comparators are evaluated once in each scan interval. Use the result (TRUE or FALSE) directly. All parameters in this parameter group are array parameters with index 0 to 5. Select index 0 to program Comparator 0, select index 1 to program Comparator 1, etc.

13-10 Comparator Operand

Array [6]

Choices [1] to [31] are variables that will be compared based on their values. Choices [50] to [186] are digital values (TRUE/FALSE) where the comparison is based on the amount of time during which they are set to TRUE or FALSE, respectively. See par. 13-11. Select the variable to be monitored by the comparator.

| | |
|----------------|--|
| [0] * DISABLED | <i>DISABLED</i> [0] The comparator is disabled. |
| [1] Reference | <i>Reference</i> [1] The resulting remote reference (not local) as a percentage. |
| [2] Feedback | <i>Feedback</i> [2] In the unit [rpm] or [Hz] |

| | | |
|------|--------------------------------|---|
| [3] | Motor speed | <i>Motor speed</i> [3] [rpm] or [Hz] |
| [4] | Motor current | <i>Motor current</i> [4] [A] |
| [5] | Motor torque | <i>Motor torque</i> [5] [Nm] |
| [6] | Motor power | <i>Motor power</i> [6] [kW] or [HP] |
| [7] | Motor voltage | <i>Motor voltage</i> [7] [V] |
| [8] | DC link voltage | <i>DC link voltage</i> [8] [V] |
| [9] | Motor thermal | <i>Motor thermal</i> [9] Expressed as a percentage. |
| [10] | VLT thermal | <i>VLT thermal</i> [10] Expressed as a percentage. |
| [11] | Heatsink temp. | <i>Heatsink temp</i> [11] Expressed as a percentage. |
| [12] | Analog input AI53 | <i>Analog input AI53</i> [12] Expressed as a percentage. |
| [13] | Analog input AI54 | <i>Analog input AI54</i> [13] Expressed as a percentage. |
| [14] | Analog input AIFB10 | <i>Analog input AIFB10</i> [14] [V] |
| [15] | Analog input AIS24V | <i>Analog input AIS24V</i> [15] [V] Analog input AICCT [17] [°]. |
| [17] | Analog input AICCT | |
| [18] | Pulse input FI29 (FC 302 only) | <i>Pulse input FI29 (FC302 Only)</i> [18] Expressed as a percentage. |
| [19] | Pulse input FI33 | <i>Pulse input FI33</i> [19] Expressed as a percentage. |
| [20] | Alarm number | <i>Alarm number</i> [20] The error number. |
| [30] | Counter A | <i>Counter A</i> [30] Number of counts |
| [31] | Counter B | <i>Counter B</i> [31] Number of counts |
| [50] | False | <i>False</i> [50] Enters the fixed value of false in the comparator. |
| [51] | True | <i>True</i> [51] Enters the fixed value of true in the comparator. |
| [52] | Control ready | <i>Control ready</i> [52] The control board receives supply voltage |
| [53] | Drive ready | <i>Drive ready</i> [53] The adjustable frequency drive is ready for operation and applies a supply signal on the control board. |
| [54] | Running | <i>Running</i> [54] The motor is running. |
| [55] | Reversing | <i>Reversing</i> [55] The output is high when the drive is running counter-clockwise (the logical product of the status bits "running" AND "reverse") |
| [56] | In range | <i>In range</i> [56] The motor is running within the programmed current and speed ranges set in par. 4-50 to par. 4-53. |
| [60] | On reference | <i>On reference</i> [60] The motor is running on reference. |
| [61] | Below reference, low | <i>Below reference, low</i> [61] The motor is running below the value given in par. 4-54 "Warning Reference Low" |

| | | |
|------|-----------------------|---|
| [62] | Above reference, high | <i>Above reference, high</i> [62] The motor is running above the value given in par. 4-55 "Warning Reference High" |
| [65] | Torque limit | <i>Torque limit</i> [65] The torque limit, set in par. 4-16 or 4-17, has been exceeded. |
| [66] | Current limit | <i>Current limit</i> [66] The motor current limit, set in par. 4-18, has been exceeded. |
| [67] | Out of current range | <i>Out of current range</i> [67] The motor current is outside the range set in par. 4-18. |
| [68] | Below I low | <i>Below I low</i> [68] The motor current is lower than set in par. 4-50. |
| [69] | Above I high | <i>Above I high</i> [69] The motor current is higher than set in par. 4-51. |
| [70] | Out of speed range | <i>Out of speed range</i> [70] The speed is outside the range set in par. 4-52 and 4-53. |
| [71] | Below speed low | <i>Below speed low</i> [71] The output speed is lower than the setting in par. 4-52. |
| [72] | Above speed high | <i>Above speed high</i> [72] The output speed is higher than the setting in par. 4-53. |
| [75] | Out of feedb. range | <i>Out of feedb. Range</i> [75] The feedback is outside the range set in par. 4-56 and 4-57. |
| [76] | Below feedb. low | <i>Below feedb. Low</i> [76] The feedback is below the limit set in par. 4-56. |
| [77] | Above feedb. high | <i>Above feedb. High</i> [77] The feedback is above the limit set in par. 4-57. |
| [80] | Thermal warning | <i>Thermal warning</i> [80] The thermal warning turns on when the temperature exceeds the limit in the motor, the adjustable frequency drive, the brake resistor or thermistor. |
| [82] | Line pwr out of range | <i>Line voltage out of range</i> [82] The line voltage is outside the specified voltage range. |
| [85] | Warning | <i>Warning</i> [85] A warning is active. |
| [86] | Alarm (trip) | <i>Alarm (trip)</i> [86] A (trip) alarm is active. |
| [87] | Alarm (trip lock) | <i>Alarm (trip lock)</i> [87] A (Trip lock) alarm is active. |
| [90] | Bus OK | <i>Bus OK</i> [90] Active communication (no timeout) via the serial communication port. |
| [91] | Torque limit & stop | <i>Torque limit & stop</i> [91] If the adjustable frequency drive has received a stop signal and is at the torque limit, the signal is logic "0." |
| [92] | Brake fault (IGBT) | <i>Brake fault (IGBT)</i> [92] The brake IGBT is short circuited. |
| [93] | Mech. brake control | <i>Mech. brake control</i> [93] The mechanical brake is active. |

| | | | |
|-------|--------------------------------|-------------------------------------|---|
| [94] | Safe stop active (FC 302 only) | <i>Safe stop active (FC302Only)</i> | [94] Safe stop is active DI 37. |
| [100] | Comparator 0 | <i>Comparator 0</i> | [100] The result of comparator 0. |
| [101] | Comparator 1 | <i>Comparator 1</i> | [101] The result of comparator 1. |
| [102] | Comparator 2 | <i>Comparator 2</i> | [102] The result of comparator 2. |
| [103] | Comparator 3 | <i>Comparator 3</i> | [103] The result of comparator 3. |
| [104] | Comparator 4 | <i>Comparator 4</i> | [104] The result of comparator 4. |
| [105] | Comparator 5 | <i>Comparator 5</i> | [105] The result of comparator 5. |
| [110] | Logic rule 0 | <i>Logic rule 0</i> | [110] The result of logic rule 0. |
| [111] | Logic rule 1 | <i>Logic rule 1</i> | [111] The result of logic rule 1. |
| [112] | Logic rule 2 | <i>Logic rule 2</i> | [112] The result of logic rule 2. |
| [113] | Logic rule 3 | <i>Logic rule 3</i> | [113] The result of logic rule 3. |
| [114] | Logic rule 4 | <i>Logic rule 4</i> | [114] The result of logic rule 4. |
| [115] | Logic rule 5 | <i>Logic rule 5</i> | [115] The result of logic rule 5. |
| [120] | SL Timeout 0 | <i>SL Timeout 0</i> | [120] The result of SLC timer 0. |
| [121] | SL Timeout 1 | <i>SL Timeout 1</i> | [121] The result of SLC timer 1. |
| [122] | SL Timeout 2 | <i>SL Timeout 2</i> | [122] The result of SLC timer 2. |
| [123] | SL Timeout 3 | <i>SL Timeout 3</i> | [123] The result of SLC timer 3. |
| [124] | SL Timeout 4 | <i>SL Timeout 4</i> | [124] The result of SLC timer 4. |
| [125] | SL Timeout 5 | <i>SL Timeout 5</i> | [125] The result of SLC timer 5. |
| [126] | SL Timeout 6 | <i>SL Timeout 6</i> | [126] The result of SLC timer 6. |
| [127] | SL Timeout 7 | <i>SL Timeout 7</i> | [127] The result of SLC timer 7. |
| [130] | Digital input DI18 | <i>Digital input DI18</i> | [130] Digital input 18. High = True. |
| [131] | Digital input DI19 | <i>Digital input DI19</i> | [131] Digital input 19. High = True. |
| [132] | Digital input DI27 | <i>Digital input DI27</i> | [132] Digital input 27. High = True. |
| [133] | Digital input DI29 | <i>Digital input DI29</i> | [133] Digital input 29. High = True. |
| [134] | Digital input DI32 | <i>Digital input DI32</i> | [134] Digital input 32. High = True. |
| [135] | Digital input DI33 | <i>Digital input DI33</i> | [135] Digital input 33. High = True. |
| [150] | SL digital output A | <i>SL digital output A</i> | [150] Use the result of the SLC output A. |
| [151] | SL digital output B | <i>SL digital output B</i> | [151] Use the result of the SLC output B. |
| [152] | SL digital output C | <i>SL digital output C</i> | [152] Use the result of the SLC output C. |
| [153] | SL digital output D | <i>SL digital output D</i> | [153] Use the result of the SLC output D. |
| [154] | SL digital output E | <i>SL digital output E</i> | [154] Use the result of the SLC output E. |

2

| | | |
|-------|---------------------|--|
| [155] | SL digital output F | <i>SL digital output F</i> [155] Use the result of the SLC output F. |
| [160] | Relay 1 | <i>Relay 1</i> [160] Relay 1 is active |
| [161] | Relay 2 | <i>Relay 2</i> [161] Relay 2 is active |
| [180] | Local ref. active | <i>Local ref. active</i> [180] High when par. 3-13 "Reference site" = [2] Local or when par 3-13 is [0] Linked to hand auto, while the LCP is in hand on mode. |
| [181] | Remote ref. active | <i>Remote ref. active</i> [181] High when par. 3-13 "Reference site" = [1] Remote or [0] Linked to hand/auto, while the LCP is in auto on mode. |
| [182] | Start command | <i>Start command</i> [182] High when there is an active start command and no stop command. |
| [183] | Drive stopped | <i>Drive stopped</i> [183] A stop command (Jog, Stop, Qstop, Coast) is issued – and not from the SLC itself. |
| [185] | Drive in hand mode | <i>Drive in hand mode</i> [185] High when the drive is in hand mode. |
| [186] | Drive in auto mode | <i>Drive in auto mode</i> [186] High when the drive is in auto mode. |

13-11 Comparator Operator

Array [6]

For par. 13-10 containing values from [0] to [31], the following is valid:
Select the operator to be used in the comparison.

| | | |
|-----|-----|--|
| [0] | < | Select < [0] for the result of the evaluation to be TRUE, when the variable selected in par. 13-10 is smaller than the fixed value in par. 13-12. The result will be FALSE if the variable selected in par. 13-10 is greater than the fixed value in par. 13-12. |
| [1] | * ≈ | Select ≈ [1] for the result of the evaluation to be TRUE, when the variable selected in par. 13-10 is approximately equal to the fixed value in par. 13-12. |
| [2] | > | Select > [2] for the inverse logic of option < [0]. |

13-12 Comparator Value

Array [6]

0.000 * [-100000.000
100000.000] - Enter the 'trigger level' for the variable that is monitored by this comparator. This is an array parameter containing comparator values 0 to 5.

2.14.4. 13-2* Timers

This parameter group consists of timer parameters. Use the result (TRUE or FALSE) from *timers* directly to define an *event* (see par. 13-51), or as boolean input in a *logic rule* (see par. 13-40, 13-42 or 13-44). A timer is only FALSE when started by an action (i.e., Start timer 1 [29]) until the timer value entered in this parameter is elapsed. Then it becomes TRUE again. All parameters in this parameter group are array parameters with index 0 to 2. Select index 0 to program Timer 0, select index 1 to program Timer 1, and so on.

13-20 SL Controller Timer

Array [8]

0.00 s* [00:00:00.000 - Enter the value to define the duration of the FALSE output from
99:59:59.999] the programmed timer. A timer is only FALSE if it is started by
an action (i.e., *Start timer 1* [29]) and until the given timer value
has elapsed.

2.14.5. 13-4* Logic Rules

Combine up to three boolean inputs (TRUE / FALSE inputs) from timers, comparators, digital inputs, status bits and events using the logical operators AND, OR, and NOT. Select boolean inputs for the calculation in par. 13-40, 13-42, and 13-44. Define the operators used to logically combine the selected inputs in par. 13-41 and 13-43.

Priority of calculation

The results of par. 13-40, 13-41, and 13-42 are calculated first. The outcome (TRUE / FALSE) of this calculation is combined with the settings of par. 13-43 and 13-44, yielding the final result (TRUE / FALSE) of the logic rule.

13-40 Logic Rule Boolean 1

Array [6]

- [0] * False
- [1] True
- [2] Running
- [3] In range
- [4] On reference
- [5] Torque limit
- [6] Current limit
- [7] Out of current range
- [8] Below I low
- [9] Above I high

2

| | |
|------|----------------------------------|
| [10] | Out of speed range |
| [11] | Below speed low |
| [12] | Above speed high |
| [13] | Out of feedb. range |
| [14] | Below feedb. low |
| [15] | Above feedb. high |
| [16] | Thermal warning |
| [17] | Line voltage out of range |
| [18] | Reversing |
| [19] | Warning |
| [20] | Alarm (trip) |
| [21] | Alarm (trip lock) |
| [22] | Comparator 0 |
| [23] | Comparator 1 |
| [24] | Comparator 2 |
| [25] | Comparator 3 |
| [26] | Logic rule 0 |
| [27] | Logic rule 1 |
| [28] | Logic rule 2 |
| [29] | Logic rule 3 |
| [30] | SL Timeout 0 |
| [31] | SL Timeout 1 |
| [32] | SL Timeout 2 |
| [33] | Digital input DI18 |
| [34] | Digital input DI19 |
| [35] | Digital input DI27 |
| [36] | Digital input DI29 (FC 302 only) |
| [37] | Digital input DI32 |
| [38] | Digital input DI33 |
| [39] | Start command |
| [40] | Drive stopped |
| [41] | Reset Trip |
| [42] | Auto-reset Trip |
| [43] | OK key |
| [44] | Reset key |
| [45] | Left key |
| [46] | Right key |
| [47] | Up key |
| [48] | Down key |
| [50] | Comparator 4 |

| | | |
|------|--------------|--|
| [51] | Comparator 5 | |
| [60] | Logic rule 4 | |
| [61] | Logic rule 5 | |
| [70] | SL Timeout 3 | |
| [71] | SL Timeout 4 | |
| [72] | SL Timeout 5 | |
| [73] | SL Timeout 6 | |
| [74] | SL Timeout 7 | Select the first Boolean (TRUE or FALSE) input for the selected logic rule. See par. 13-01, <i>Start Event</i> ([0] - [61]), and par. 13-02, <i>Stop Event</i> ([70] - [74]) , for further description. |

13-41 Logic Rule Operator 1

Array [6]

| | | |
|-------|-------------|---|
| | | Select the first logical operator to use on the boolean inputs from par. 13-40 and 13-42. [13 -XX] signifies the boolean input of par. 13-*. |
| [0] * | DISABLED | Ignores par. 13-42, 13-43, and 13-44. |
| [1] | AND | evaluates the expression [13-40] AND [13-42]. |
| [2] | OR | evaluates the expression [13-40] OR [13-42]. |
| [3] | AND NOT | evaluates the expression [13-40] AND NOT [13-42]. |
| [4] | OR NOT | evaluates the expression [13-40] OR NOT [13-42]. |
| [5] | NOT AND | evaluates the expression NOT [13-40] AND [13-42]. |
| [6] | Not or | evaluates the expression NOT [13-40] OR [13-42]. |
| [7] | Not and not | evaluates the expression NOT [13-40] AND NOT [13-42]. |
| [8] | Not or not | evaluates the expression NOT [13-40] OR NOT [13-42]. |

13-42 Logic Rule Boolean 2

Array [6]

| | |
|-----|--------------|
| [0] | False |
| [1] | True |
| [2] | Running |
| [3] | In range |
| [4] | On reference |
| [5] | Torque limit |

2

| | |
|------|-------------------------------------|
| [6] | Current limit |
| [7] | Out of current range |
| [8] | Below I low |
| [9] | Above I high |
| [10] | Out of speed range |
| [11] | Below speed low |
| [12] | Above speed high |
| [13] | Out of feedb. range |
| [14] | Below feedb. low |
| [15] | Above feedb. high |
| [16] | Thermal warning |
| [17] | Line pwr out of range |
| [18] | Reversing |
| [19] | Warning |
| [20] | Alarm (trip) |
| [21] | Alarm (trip lock) |
| [22] | Comparator 0 |
| [23] | Comparator 1 |
| [24] | Comparator 2 |
| [25] | Comparator 3 |
| [26] | Logic rule 0 |
| [27] | Logic rule 1 |
| [28] | Logic rule 2 |
| [29] | Logic rule 3 |
| [30] | SL Timeout 0 |
| [31] | SL Timeout 1 |
| [32] | SL Timeout 2 |
| [33] | Digital input DI18 |
| [34] | Digital input DI19 |
| [35] | Digital input DI27 |
| [36] | Digital input DI29 (FC 302 only) |
| [37] | Digital input DI32 |
| [38] | Digital input DI33 |
| [39] | Start command |
| [40] | Drive stopped |
| [41] | Reset Trip |
| [42] | Auto-reset Trip |
| [43] | OK key |
| [44] | Reset key |
| [45] | Left key |
| [46] | Right key |

| | | |
|------|--------------|---|
| [47] | Up key | |
| [48] | Down key | |
| [50] | Comparator 4 | |
| [51] | Comparator 5 | |
| [60] | Logic rule 4 | |
| [61] | Logic rule 5 | |
| [70] | SL Timeout 3 | |
| [71] | SL Timeout 4 | |
| [72] | SL Timeout 5 | |
| [73] | SL Timeout 6 | |
| [74] | SL Timeout 7 | Select the second Boolean (TRUE or FALSE) input for the selected logic rule. See par. 13-01, <i>Start Event</i> ([0] - [61]), and par. 13-02, <i>Stop Event</i> ([70] - [74]), for further description. |

13-43 Logic Rule Operator 2

Array [6]

Select the second logical operator to be used on the boolean input calculated in par. 13-40, 13-41 and 13-42, and the boolean input coming from par. 13-42.
 [13-44] signifies the boolean input of par. 13-44.
 [13-40/13-42] signifies the boolean input calculated in par. 13-40, 13-41, and 13-42. DISABLED [0] (factory setting): select this option to ignore par. 13-44.

| | | |
|-------|-------------|---|
| [0] * | DISABLED | |
| [1] | AND | Evaluates the expression [13-40/13-42] AND [13-44]. |
| [2] | OR | Evaluates the expression [13-40/13-42] OR [13-44]. |
| [3] | AND NOT | Evaluates the expression [13-40/13-42] AND NOT [13-44]. |
| [4] | OR NOT | Evaluates the expression [13-40/13-42] OR NOT [13-44]. |
| [5] | NOT AND | evaluates the expression NOT [13-40/13-42] AND [13-44]. |
| [6] | NOT OR | Evaluates the expression NOT [13-40/13-42] OR [13-44]. |
| [7] | NOT AND NOT | Evaluates the expression NOT [13-40/13-42] and evaluates AND NOT [13-44]. |
| [8] | NOT OR NOT | Evaluates the expression NOT [13-40/13-42] OR NOT [13-44]. |

13-44 Logic Rule Boolean 3

Array [6]

2

| | |
|------|----------------------------------|
| [0] | False |
| [1] | True |
| [2] | Running |
| [3] | In range |
| [4] | On reference |
| [5] | Torque limit |
| [6] | Current limit |
| [7] | Out of current range |
| [8] | Below I low |
| [9] | Above I high |
| [10] | Out of speed range |
| [11] | Below speed low |
| [12] | Above speed high |
| [13] | Out of feedb. range |
| [14] | Below feedb. low |
| [15] | Above feedb. high |
| [16] | Thermal warning |
| [17] | Line pwr out of range |
| [18] | Reversing |
| [19] | Warning |
| [20] | Alarm (trip) |
| [21] | Alarm (trip lock) |
| [22] | Comparator 0 |
| [23] | Comparator 1 |
| [24] | Comparator 2 |
| [25] | Comparator 3 |
| [26] | Logic rule 0 |
| [27] | Logic rule 1 |
| [28] | Logic rule 2 |
| [29] | Logic rule 3 |
| [30] | SL Timeout 0 |
| [31] | SL Timeout 1 |
| [32] | SL Timeout 2 |
| [33] | Digital input DI18 |
| [34] | Digital input DI19 |
| [35] | Digital input DI27 |
| [36] | Digital input DI29 (FC 302 only) |
| [37] | Digital input DI32 |
| [38] | Digital input DI33 |
| [39] | Start command |
| [40] | Drive stopped |

| | | |
|------|-----------------|--|
| [41] | Reset Trip | |
| [42] | Auto-reset Trip | |
| [43] | OK key | |
| [44] | Reset key | |
| [45] | Left key | |
| [46] | Right key | |
| [47] | Up key | |
| [48] | Down key | |
| [50] | Comparator 4 | |
| [51] | Comparator 5 | |
| [60] | Logic rule 4 | |
| [61] | Logic rule 5 | |
| [70] | SL Timeout 3 | |
| [71] | SL Timeout 4 | |
| [72] | SL Timeout 5 | |
| [73] | SL Timeout 6 | |
| [74] | SL Timeout 7 | Select the third Boolean (TRUE or FALSE) input for the selected logic rule. See par. 13-01, <i>Start Event</i> ([0] - [61]), and par. 13-02, <i>Stop Event</i> ([70] - [74]), for further description. |

2.14.6. 13-5* States

Parameters for Programming the Smart Logic Controller.

13-51 SL Controller Event

Array [20]

| | |
|------|----------------------|
| [0] | False |
| [1] | True |
| [2] | Running |
| [3] | In range |
| [4] | On reference |
| [5] | Torque limit |
| [6] | Current limit |
| [7] | Out of current range |
| [8] | Below I low |
| [9] | Above I high |
| [10] | Out of speed range |
| [11] | Below speed low |
| [12] | Above speed high |
| [13] | Out of feedb. range |

2

| | |
|------|----------------------------------|
| [14] | Below feedb. low |
| [15] | Above feedb. high |
| [16] | Thermal warning |
| [17] | Line pwr out of range |
| [18] | Reversing |
| [19] | Warning |
| [20] | Alarm (trip) |
| [21] | Alarm (trip lock) |
| [22] | Comparator 0 |
| [23] | Comparator 1 |
| [24] | Comparator 2 |
| [25] | Comparator 3 |
| [26] | Logic rule 0 |
| [27] | Logic rule 1 |
| [28] | Logic rule 2 |
| [29] | Logic rule 3 |
| [30] | SL Timeout 0 |
| [31] | SL Timeout 1 |
| [32] | SL Timeout 2 |
| [33] | Digital input DI18 |
| [34] | Digital input DI19 |
| [35] | Digital input DI27 |
| [36] | Digital input DI29 (FC 302 only) |
| [37] | Digital input DI32 |
| [38] | Digital input DI33 |
| [39] | Start command |
| [40] | Drive stopped |
| [41] | Reset Trip |
| [42] | Auto-reset Trip |
| [43] | OK key |
| [44] | Reset key |
| [45] | Left key |
| [46] | Right key |
| [47] | Up key |
| [48] | Down key |
| [50] | Comparator 4 |
| [51] | Comparator 5 |
| [60] | Logic rule 4 |
| [61] | Logic rule 5 |
| [70] | SL Timeout 3 |
| [71] | SL Timeout 4 |

| | | |
|------|--------------|---|
| [72] | SL Timeout 5 | |
| [73] | SL Timeout 6 | |
| [74] | SL Timeout 7 | Select the Boolean input (TRUE or FALSE) to define the smart logic controller event. See par. 13-01, <i>Start Event</i> ([0] - [61]), and par. 13-02, <i>Stop Event</i> ([70] - [74]), for further description. |

13-52 SL Controller Action

Array [20]

| | | | |
|-------|---------------------------|--------|--|
| [0] * | Disabled | | Select the action corresponding to the SLC event. Actions are executed when the corresponding event (defined in par. 13-51) is evaluated as true. The following actions are available for selection: <i>*DISABLED</i> [0] |
| [1] | No action | | <i>No action</i> [1] |
| [2] | Select set-up 1 | | <i>Select set-up 1</i> [2] - changes the active set-up (par. 0-10) to '1'. |
| [3] | Select set-up 2 | | <i>Select set-up 2</i> [3] - changes the active set-up (par. 0-10) to '2'. |
| [4] | Select set-up 3 | | <i>Select set-up 3</i> [4] - changes the active set-up (par. 0-10) to '3'. |
| [5] | Select set-up 4 | | <i>Select set-up 4</i> [5] - changes the active set-up (par. 0-10) to '4'. If the set-up is changed, it will merge with other set-up commands coming from either the digital inputs or via a serial communication bus. |
| [10] | Select preset reference 0 | refer- | <i>Select preset reference 0</i> [10] – selects preset reference 0. |
| [11] | Select preset reference 1 | refer- | <i>Select preset reference 1</i> [11] – selects preset reference 1. |
| [12] | Select preset reference 2 | refer- | <i>Select preset reference 2</i> [12] – selects preset reference 2. |
| [13] | Select preset reference 3 | refer- | <i>Select preset reference 3</i> [13] – selects preset reference 3. |
| [14] | Select preset reference 4 | refer- | <i>Select preset reference 4</i> [14] – selects preset reference 4. |
| [15] | Select preset reference 5 | refer- | <i>Select preset reference 5</i> [15] – selects preset reference 5. |
| [16] | Select preset reference 6 | refer- | <i>Select preset reference 6</i> [16] – selects preset reference 6. |
| [17] | Select preset reference 7 | refer- | <i>Select preset reference 7</i> [17] - selects preset reference 7. If the active preset reference is changed, it will merge with other preset reference commands coming from either the digital inputs or via a serial communication bus. |
| [18] | Select ramp 1 | | <i>Select ramp 1</i> [18] - selects ramp 1. |

| | | |
|------|---------------------------|--|
| [19] | Select ramp 2 | <i>Select ramp 2</i> [19] - selects ramp 2. |
| [20] | Select ramp 3 | <i>Select ramp 3</i> [20] - selects ramp 3. |
| [21] | Select ramp 4 | <i>Select ramp 4</i> [21] - selects ramp 4. |
| [22] | Run | <i>Run</i> [22] - issues a start command to the adjustable frequency drive. |
| [23] | Run reverse | <i>Run reverse</i> [23] - issues a start reverse command to the adjustable frequency drive. |
| [24] | Stop | <i>Stop</i> [24] - issues a stop command to the adjustable frequency drive. |
| [25] | Qstop | <i>Qstop</i> [25] - issues a quick stop command to the adjustable frequency drive. |
| [26] | Dcstop | <i>Dcstop</i> [26] - issues a DC stop command to the adjustable frequency drive. |
| [27] | Coast | <i>Coast</i> [27] - the adjustable frequency drive coasts immediately. All stop commands (including the coast command) stop the SLC. |
| [28] | Freeze output | <i>Freeze output</i> [28] - freezes the output frequency of the adjustable frequency drive. |
| [29] | Start timer 0 | <i>Start timer 0</i> [29] - starts timer 0; see par. 13-20 for further description. |
| [30] | Start timer 1 | <i>Start timer 1</i> [30] - starts timer 1; see par. 13-20 for further description. |
| [31] | Start timer 2 | <i>Start timer 2</i> [31] - starts timer 2; see par. 13-20 for further description. |
| [32] | Set digital output A low | <i>Set digital output A low</i> [32] - any output with SL output A will be low. |
| [33] | Set digital output B low | <i>Set digital output B low</i> [33] - any output with SL output B will be low. |
| [34] | Set digital output C low | <i>Set digital output C low</i> [34] - any output with SL output C will be low. |
| [35] | Set digital output D low | <i>Set digital output D low</i> [35] - any output with SL output D will be low. |
| [36] | Set digital output E low | <i>Set digital output E low</i> [36] - any output with SL output E will be low. |
| [37] | Set digital output F low | <i>Set digital output F low</i> [37] - any output with SL output F will be low. |
| [38] | Set digital output A high | <i>Set digital output A high</i> [38] - any output with SL output A will be high. |
| [39] | Set digital output B high | <i>Set digital output B high</i> [39] - any output with SL output B will be high. |

| | | |
|------|---------------------------|--|
| [40] | Set digital output C high | <i>Set digital output C high</i> [40] - any output with SL output C will be high. |
| [41] | Set digital output D high | <i>Set digital output D high</i> [41] - any output with SL output D will be high. |
| [42] | Set digital output E high | <i>Set digital output E high</i> [42] - any output with SL output E will be high. |
| [43] | Set digital output F high | <i>Set digital output F high</i> [43] - any output with SL output F will be high. |
| [60] | Reset Counter A | <i>Reset Counter A</i> [60] - resets Counter A to zero. |
| [61] | Reset Counter B | <i>Reset Counter B</i> [61] - resets Counter B to zero. |
| [70] | Start Timer 3 | <i>Start Timer 3</i> [70] - Start Timer 3; see par. 13-20 for further description. |
| [71] | Start Timer 4 | <i>Start Timer 4</i> [71] - Start Timer 4; see par. 13-20 for further description. |
| [72] | Start Timer 5 | <i>Start Timer 5</i> [72] - Start Timer 5; see par. 13-20 for further description. |
| [73] | Start Timer 6 | <i>Start Timer 6</i> [73] - Start Timer 6; see par. 13-20 for further description. |
| [74] | Start Timer 7 | <i>Start Timer 7</i> [74] - Start Timer 7; see par. 13-20 for further description. |

2.15. Parameters: Special Functions

2

2.15.1. 14-** Special Functions

Parameter group for configuring special adjustable frequency drive functions.

2.15.2. Inverter Switching, 14-0*

Parameters for configuring the inverter switching.

14-00 Switching Pattern

| Option: | Function: |
|-------------|---|
| [0] 60 AVM | |
| [1] * SFAVM | Select the switching pattern: 60° AVM or SFAVM. |

14-01 Switching Frequency

| Option: | Function: |
|-------------|-----------|
| [1] 1.5 kHz | |

14-03 Overmodulation

| Option: | Function: |
|----------|--|
| [0] Off | |
| [1] * On | Select <i>On</i> [1] to connect the overmodulation function for the output voltage, and in order to obtain an output voltage of up to 15% higher than the line voltage. Select <i>Off</i> [0] for no overmodulation of the output voltage, and in order to avoid torque ripple on the motor shaft. This feature may be useful for applications such as grinding machines. |

14-04 PWM Random

| Option: | Function: |
|-----------|---|
| [0] * Off | |
| [1] On | Select <i>On</i> [1] to transform the acoustic motor switching noise from a clear ring tone into a less discernable 'white' noise. This is achieved by slightly and randomly altering the synchronism of the pulse width modulated output phases. Select <i>Off</i> [0] for no change to the acoustic motor switching noise. |

2.15.3. 14-1* Line Supply On/Off

Parameters for configuring line failure monitoring and handling. If a line failure appears, the adjustable frequency drive will try to continue in a controlled manner until the power in the DC link has been exhausted.

14-10 Line Failure

| Option: | Function: |
|--------------------------------|-----------------|
| [0] * No function | |
| [1] Controlled ramp-down | ramp-down |
| [2] Controlled ramp-down, trip | ramp-down, trip |
| [3] Coasting | |
| [4] Kinetic backup | |
| [5] Kinetic backup, trip | |
| [6] Alarm | |

Function: Select the function to which the adjustable frequency drive must act when the threshold in par 14-11 has been reached.

Par 14-10 cannot be changed while motor is running.

Controlled ramp-down:

The adjustable frequency drive will perform a controlled ramp-down. If Par 2-10 is [0] or AC brake [2] Off the ramp will follow the overvoltage ramping. If par. 2-10 is [1] *Resistor Brake*, the ramp will follow the setting in par. 3-81, Quick Stop Ramp Time.

Controlled ramp-down [1]:

After power-up, the adjustable frequency drive is ready for start. Controlled ramp-down and trip [2]: after power-up, the adjustable frequency drive needs a reset for starting.

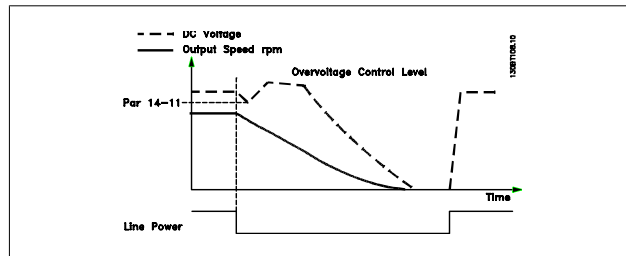
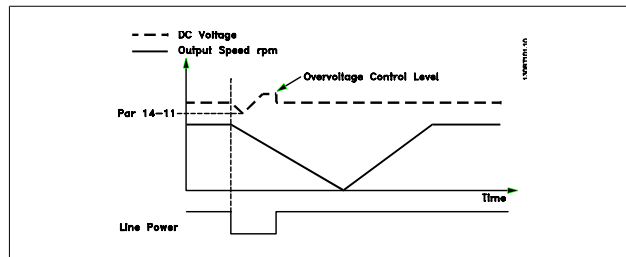

1. The power is back before the energy from DC / moment of inertia from load is too low. The adjustable frequency drive will perform a controlled ramp-down when par 14-11 level has been reached.

- The adjustable frequency drive will perform a controlled ramp-down as long as energy in the DC link is present. After this point, the motor will be coasted.

2

Kinetic backup:

The adjustable frequency drive will perform a kinetic backup. If par. 2-10 is [0] or AC brake [2] *Off*, the ramp will perform overvoltage ramping. If par. 2-10 is [1] *Resistor Brake*, the ramp will follow the setting in par. 3-81 *Quick stop ramp time*.

Kinetic Backup [4]: The adjustable frequency drive will keep on running as long as there is energy in the system due to the moment of inertia produced by the load.

Kinetic Backup [5]: The adjustable frequency drive will ride through on speed as long as the energy is present from moment of inertia from the load. If the DC voltage goes below par. 14-11, the adjustable frequency drive will perform a trip.

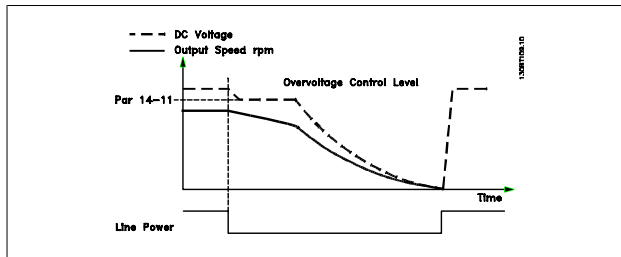
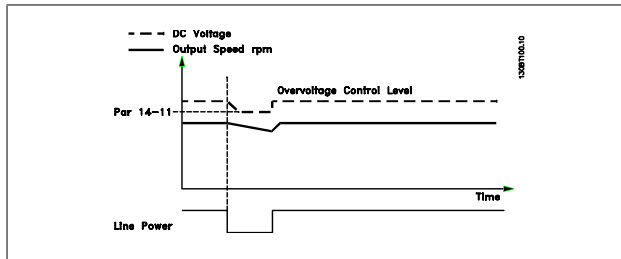

14-11 Line Voltage at Line Fault

| | |
|-------------------------------------|--|
| Range: 342 V* [150-600 V] | Function: This parameter defines the threshold voltage at which the selected function in par. 14-10 should be activated. |
|-------------------------------------|--|

14-12 Function at Line Imbalance

| | |
|---|---|
| Option: [0] * Trip [1] Warning [2] Disabled | Function: When a severe line imbalance is detected: <i>Select Trip</i> [0] to trip the adjustable frequency drive; |
|---|---|

Select *Warning* [1] to issue a warning; or select *Disabled* [2] for no action.

Operating under severe line imbalance conditions reduces the lifetime of the motor. Conditions are considered severe if the motor operates continuously near nominal load (such as when a pump or fan runs near full speed).

2.15.4. Trip Reset, 14-2*

Parameters for configuring auto reset handling, special trip handling and control card self test or initialization.

| 14-20 Reset Mode | |
|------------------|--------------------------|
| Option: | Function: |
| [0] * | Manual reset |
| [1] | Automatic reset x 1 |
| [2] | Automatic reset x 2 |
| [3] | Automatic reset x 3 |
| [4] | Automatic reset x 4 |
| [5] | Automatic reset x 5 |
| [6] | Automatic reset x 6 |
| [7] | Automatic reset x 7 |
| [8] | Automatic reset x 8 |
| [9] | Automatic reset x 9 |
| [10] | Automatic reset x 10 |
| [11] | Automatic reset x 15 |
| [12] | Automatic reset x 20 |
| [13] | Infinite Automatic Reset |

Select the reset function after tripping. Once reset, the drive can be restarted.
 Select *Manual reset* [0] to perform a reset via [RESET] or via the digital inputs.
 Select *Automatic reset x 1... x20* [1]-[12] to perform between one and twenty automatic resets after tripping.
 Select *Infinite Automatic Reset* [13] for continuous resetting after tripping.

**NOTE**

The motor may start without warning. If the specified number of AUTOMATIC RESETs is reached within 10 minutes, the drive enters manual reset [0] mode. After the manual reset is performed, the setting of par. 14-20 reverts to the original selection. If the number of automatic resets is not reached within 10 minutes, or when a manual reset is performed, the internal AUTOMATIC RESET counter returns to zero.

**NOTE**

Automatic reset will also be active for resetting safe stop function in firmware version < 4.3x.

14-21 Automatic Restart Time

Range:

10 s* [0 - 600 s]

Function:

Enter the time interval from trip to start of the automatic reset function. This parameter is active when par. 14-20 is set to *Automatic reset* [1] - [13].

14-22 Operation Mode

Option:

[0] * Normal operation
[1] Control card test
[2] Initialization

Function:

Use this parameter to specify normal operation, to perform tests or to initialize all parameters except par. 15-03, 15-04 and 15-05. This function is active only when the power is cycled to the adjustable frequency drive.

Select *Normal operation* [0] for normal operation of the adjustable frequency drive with the motor in the selected application. Select *Control card test* [1] to test the analog and digital inputs and outputs and the +10 V control voltage. The test requires a test connector with internal connections. Use the following procedure for the control card test:

1. Select *Control card test* [1].
2. Disconnect the line supply and wait for the light in the display to go out.
3. Set switches S201 (A53) and S202 (A54) = 'ON' / I.
4. Insert the test plug (see below).
5. Connect to line supply.
6. Carry out various tests.

7. The results are displayed on the LCP, and the adjustable frequency drive moves into an infinite loop.
8. Par. 14-22 is automatically set to normal operation. Carry out a power cycle to start up in normal operation after a control card test.

If the test is OK:

LCP readout: Control Card OK.

Disconnect the line supply and remove the test plug. The green LED on the control card will light up.

If the test fails:

LCP readout: Control Card I/O failure.

Replace the adjustable frequency drive or control card. The red LED on the control card is turned on. Test plugs (connect the following terminals to each other): 18 - 27 - 32; 19 - 29 - 33; 42 - 53 - 54

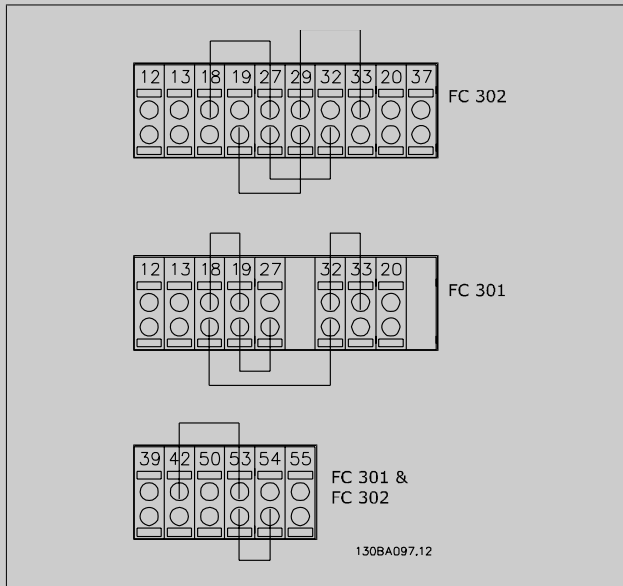

Select Initialization [2] to reset all parameter values to default settings, except for par. 15-03, 15-04 and 15-05. The adjustable frequency drive will reset during the next power-up. Par. 14-22 will also revert to the default setting *Normal operation* [0].

14-25 Trip Delay at Torque Limit

Range:

60 s* [0 - 60 s]

Function:

Enter the torque limit trip delay in seconds. When the output torque reaches the torque limits (par. 4-16 and 4-17), a warning is triggered. When the torque limit warning has been continuously present for the period specified in this parameter, the adjustable frequency drive trips. Disable the trip delay by setting

2

the parameter to 60 s = OFF. Thermal monitoring of the adjustable frequency drive will still remain active.

14-26 Trip Delay at Inverter Fault

Range:

Size re- [0 - 30 s]
lated

Function:

When the adjustable frequency drive detects an overvoltage in the set time, tripping will be affected after the set time.
If value = 0, *protection mode* is disabled

NOTE

It is recommended to disable *protection mode* in hoisting applications.

14-29 Service Code

Range:

000000 [000000 Hex - FFFFF] For internal service only.

Function:

2.15.5. 14-3* Current Limit Control

The FC 300 series features an integral current limit controller, which is activated when the motor current, and thus the torque, are higher than the torque limits set in par. 4-16 and 4-17.

When the current limit is reached during motor operation or regenerative operation, the adjustable frequency drive will try to reduce torque below the preset torque limits as quickly as possible without losing control of the motor.

While the current control is active, the adjustable frequency drive can only be stopped by setting a digital input to *Coast inverse* [2] or *Coast and reset inv.* [3]. Any signal on terminals 18 to 33 will not be active until the adjustable frequency drive is no longer near the current limit.

By using a digital input set to *Coast inverse* [2] or *Coast and reset inv.* [3], the motor does not use the ramp-down time because the drive is coasted. If a quick stop is necessary, use the mechanical brake control function along with an external electro-mechanical brake attached to the application.

14-30 Current Lim Cont, Proportional Gain

Range:

100 %* [0 - 500 %]

Function:

Enter the proportional gain value for the current limit controller. Selection of a high value makes the controller react faster. Too high a setting leads to controller instability.

14-31 Current Lim. Contr., Integration Time

Range:

0.020 s* [0.002 - 2.000 s]

Function:

Controls the current limit control integration time. Setting it to a lower value makes it react faster. A setting that is too low leads to control instability.

2.15.6. 14-4* Energy Optimizing

Parameters for adjusting the energy optimization level in both Variable Torque (VT) and Automatic Energy Optimization (AEO) mode.

14-40 VT Level

Range:

66%* [40 - 90%]

Function:

Enter the level of motor magnetization at low speed. Selection of a low value reduces energy loss in the motor, but also reduces load capability.

This parameter cannot be adjusted while the motor is running.

14-41 AEO Minimum Magnetization

Range:

40%* [40 - 75%]

Function:

Enter the minimum allowable magnetization for AEO. Selection of a low value reduces energy loss in the motor, but can also reduce resistance to sudden load changes.

14-42 Minimum AEO Frequency

Range:

10Hz* [5 - 40 Hz]

Function:

Enter the minimum frequency at which Automatic Energy Optimization (AEO) is to be active.

14-43 Motor Cos-phi

Range:

0.66* [0.40 - 0.95]

Function:

The Cos(phi) setpoint is automatically set for optimum AEO performance. This parameter should normally not be altered. However, in some situations it may be necessary to enter a new value to fine tune.

2.15.7. Environment, 14-5*

These parameters help the adjustable frequency drive to operate under special environmental conditions.

14-50 RFI 1

Option:

[0] Off

[1] * On

Function:

Select *On* [1] to ensure the adjustable frequency drive complies with EMC standards.

Select *Off* [0] only when the adjustable frequency drive is supplied from an isolated line power source, i.e., IT line power. In this mode, the internal RFI capacities (filter capacitors) between chassis and the Line Power RFI Filter Circuit are cut off to avoid damage to the intermediate circuit and to reduce the ground capacity currents (according to IEC 61800-3).

14-52 Fan Control

Option:
Function:

[0] * Auto

[1] On 50%

[2] On 75%

[3] On 100%

Select minimum speed of the internal fan.

Select *Auto* [0] to run fan only when internal temperature in adjustable frequency drive is in the range of 95°F [35°C] to approximately 131°F [55°C].

Fan runs at low speed below 95°F [35°C], and at full speed at approximately 131°F [55°C].

14-53 Fan Monitor

Option:
Function:

[0] Disabled

[1] * Warning

[2] Trip

Select which action the adjustable frequency drive should take in case a fan fault is detected.

14-55 Output Filter

Option:
Function:

[0] * No filter

[1] Sine-Wave Filter

Select the type of output filter connected. This parameter cannot be adjusted while motor is running.

14-56 Capacitance Output Filter

Range:
Function:

2.0 μF * [0.1 - 6500.0 μF]

Set the capacitance of the output filter. The value can be found on the filter label.

NOTE

This is required for correct compensation in flux mode (par. 1-01)

14-57 Inductance Output Filter

Range:

 7.000 [0.001 - 65.000 mH]
 mH*

Function:

Set the inductance of the output filter. The value can be found on the filter label.

NOTE

This is required for correct compensation in flux mode (par. 1-01)

2.15.8. 14-7* Compatibility

This parameter is used for setting the compatibility for the VLT 3000, VLT 5000 to the FC 300

14-72 VLT Alarm Word

Range:

0* [0 - 4294967295]

Function:

Read out the alarm word corresponding to VLT 3000 or VLT 5000

14-73 VLT Warning Word

Range:

0* [0 - 4294967295]

Function:

Read out the warning word corresponding to VLT 3000 or VLT 5000

14-74 VLT Ext. Status Word

Range:

0* [0 - 4294967295]

Function:

Read out the ext. status word corresponding to VLT 3000 or VLT 5000

2.16. Parameters: Drive Information

2

2.16.1. 15-** Drive Information

Parameter group containing adjustable frequency drive information such as operating data, hardware configuration and software versions.

2.16.2. 15-0* Operating Data

Parameter group containing operating data, such as operating hours, kWh counters, power-ups, etc.

15-00 Operating Hours

| | |
|---------------------------|---|
| Range: | Function: |
| 0h* [0 - 2,147,483,647 h] | View how many hours the adjustable frequency drive has run. The value is saved when the adjustable frequency drive is turned off. |

15-01 Running Hours

| | |
|---------------------------|---|
| Range: | Function: |
| 0h* [0 - 2,147,483,647 h] | View how many hours the motor has run. Reset the counter in par. 15-07. The value is saved when the adjustable frequency drive is turned off. |

15-02 kWh Counter

| | |
|--------------------------------|--|
| Range: | Function: |
| 0 kWh* [0 - 2,147,483,647 kWh] | Registering the power consumption of the motor as a mean value over one hour. Reset the counter in par. 15-06. |

15-03 Power-ups

| | |
|---------------------|--|
| Range: | Function: |
| 0* [0 - 2147483647] | View the number of times the adjustable frequency drive has been powered up. |

15-04 Overtmps

| | |
|----------------|--|
| Range: | Function: |
| 0* [0 - 65535] | View the number of adjustable frequency drive temperature faults that have occurred. |

15-05 Overvolts

| | |
|----------------|--|
| Range: | Function: |
| 0* [0 - 65535] | View the number of adjustable frequency drive overvoltages that have occurred. |

15-06 Reset kWh Counter

| | |
|--------------------|---|
| Option: | Function: |
| [0] * Do not reset | |
| [1] Reset counter | Select <i>Reset</i> [1] and press [OK] to reset the kWh counter to zero (see par 15-02). Select <i>Do not reset</i> [0] if no reset of the kWh counter is desired. |



NOTE
The reset is carried out by pressing [OK].

15-07 Reset Running Hours Counter

| | |
|--------------------|---|
| Option: | Function: |
| [0] * Do not reset | |
| [1] Reset counter | Select <i>Reset</i> [1] and press [OK] to reset the Running Hours counter to zero (see par. 15-01). This parameter cannot be selected via the serial port, RS-485. Select <i>Do not reset</i> [0] if no reset of the Running Hours counter is desired. |

2.16.3. Data Log Settings, 15-1*

The data log enables continuous logging of up to 4 data sources (par. 15-10) at individual rates (par. 15-11). A trigger event (par. 15-12) and window (par. 15-14) are used to start and stop the logging conditionally.

15-10 Logging Source

| |
|-------------------------------|
| Array [4] |
| None |
| 14-72 VLT Alarm Word |
| 14-73 VLT Warning Word |
| 14-74 VLT Ext. Status Word |

2

[16-00
Control
Word]

16-01 Reference
[Unit]

16-02 Reference %

16-03 Status Word

16-10 Power [kW]

16-11 Power [HP]

16-12 Motor Voltage

16-13 Frequency

16-14 Motor Current

16-16 Torque

16-17 Speed [rpm]

16-18 Motor Thermal

16-30 DC Link Voltage

16-32 Brake Energy/
sec.

16-33 Brake Energy/2
min

16-34 Heatsink Temp.

16-35 Inverter Ther-
mal

16-50 External Refer-
ence

16-51 Pulse Refer-
ence

16-52 Feedback
[Unit]

16-54 Feedback 1
[Unit]

16-55 Feedback 2
[Unit]

16-56 Feedback 3
[Unit]

16-60 Digital Input

16-62 Analog Input
53

16-64 Analog Input
54

16-65 Analog Output
42 [mA]

16-66 Digital Output
[bin]

16-75 Analog In
X30/11

16-76 Analog In
X30/12

16-77 Analog Out
X30/8 [mA]

16-90 Alarm Word

16-92 Warning Word

16-94 Extended Sta-
tus Word

34-70 MCO Alarm
Word 1

34-71 MCO Alarm Select which variables are to be logged.
Word 2

15-11 Logging Interval

Range:

1ms* [1 - 86400000 ms]

Function:

Enter the interval in milliseconds between each sampling of the variables to be logged.

15-12 Trigger Event

Option:

[0] * False

[1] True

[2] Running

[3] In range

[4] On reference

[5] Torque limit

[6] Current limit

[7] Out of current range

[8] Below I low

[9] Above I high

[10] Out of speed range

[11] Below speed low

[12] Above speed high

[13] Out of feedb. range

[14] Below feedb. low

[15] Above feedb. high

[16] Thermal warning

[17] Line voltage out of
range

[18] Reversing

| | | |
|------|----------------------------------|---|
| [19] | Warning | |
| [20] | Alarm (trip) | |
| [21] | Alarm (trip lock) | |
| [22] | Comparator 0 | |
| [23] | Comparator 1 | |
| [24] | Comparator 2 | |
| [25] | Comparator 3 | |
| [26] | Logic rule 0 | |
| [27] | Logic rule 1 | |
| [28] | Logic rule 2 | |
| [29] | Logic rule 3 | |
| [33] | Digital input DI18 | |
| [34] | Digital input DI19 | |
| [35] | Digital input DI27 | |
| [36] | Digital input DI29 (FC 302 only) | |
| [37] | Digital input DI32 | |
| [38] | Digital input DI33 | |
| [50] | Comparator 4 | |
| [51] | Comparator 5 | |
| [60] | Logic rule 4 | |
| [61] | Logic rule 5 | Select the trigger event. When the trigger event occurs, a window is applied to freeze the log. The log will then retain a specified percentage of samples before the occurrence of the trigger event (par. 15-14). |

15-13 Logging Mode

| Option: | Function: |
|-------------------------|---|
| [0] * Log always | |
| [1] Log once on trigger | Select <i>Log always</i> [0] for continuous logging. Select <i>Log once on trigger</i> [1] to conditionally start and stop logging using par. 15-12 and par. 15-14. |

15-14 Samples Before Trigger

| Range: | Function: |
|---------------|---|
| 50* [0 - 100] | Enter the percentage of all samples prior to trigger events, which are to be retained in the log. See also par. 15-12 and par. 15-13. |

2.16.4. Historic Log,15-2*

View up to 50 logged data items via the array parameters in this parameter group. For all parameters in the group, [0] is the most recent data and [49] the oldest data. Data is logged every time an *event* occurs (not to be confused with SLC events). *Events* in this context are defined as a change in one of the following areas:

1. Digital input
2. Digital outputs (not monitored in this SW release)
3. Warning word
4. Alarm word
5. Status word
6. Control word
7. Extended status word

Events are logged with value, and time stamp in msec. The time interval between two events depends on how often *events* occur (maximum once every scan time). Data logging is continuous, but if an alarm occurs, the log is saved, and the values can be viewed on the display. This feature is useful, for example, when carrying out service following a trip. View the historic log contained in this parameter via the serial communication port or via the display.

15-20 Historic Log: Event

Array [50]

0* [0 - 255] View the event type of the logged events.

15-21 Historic Log: Value

Array [50]

0* [0 - 2147483647] View the value of the logged event. Interpret the event values according to this table:

| | |
|---|---|
| Digital input | Decimal value. See par. 16-60 for description after converting to binary value. |
| Digital output (not monitored in this SW release) | Decimal value. See par. 16-66 for description after converting to binary value. |
| Warning word | Decimal value. See par. 16-92 for description. |
| Alarm word | Decimal value. See par. 16-90 for description. |
| Status word | Decimal value. See par. 16-03 for description after converting to binary value. |
| Control word | Decimal value. See par. 16-00 for description. |
| Extended status word | Decimal value. See par. 16-94 for description. |

2

15-22 Historic Log: Time

Array [50]

0* [0 - 2147483647] View the time at which the logged event occurred. Time is measured in ms, from the time the adjustable frequency drive was started. The max. value corresponds to approx. 24 days, which means that the count will restart at zero after this time period.

2.16.5. Fault Log, 15-3*

Parameters in this group are array parameters in which up to 10 fault logs can be viewed. [0] is the most recent logged data, and [9] the oldest. Error codes, values and time stamp can be viewed for all logged data.

15-30 Fault Log: Error Code

Array [10]

0* [0 - 255] View the error code and look up its meaning in the *Troubleshooting* chapter in the FC 300 Design Guide.

15-31 Fault Log: Value

Array [10]

0* [-32767 - 32767] View an extra description of the error. This parameter is mostly used in combination with alarm 38, 'internal fault.'

15-32 Fault Log: Time

Array [10]

0* [0 - 2147483647] View the time when the logged event occurred. Time is measured in seconds, from the time the adjustable frequency drive was started.

2.16.6. Drive Identification, 15-4*

Parameters containing read only information about the hardware and software configuration of the adjustable frequency drive.

15-40 FC Type

Option:**Function:**

View the FC type. The readout is identical to the FC 300 Series power field of the type code definition, characters 1-6.

15-41 Power Section

Option:**Function:**

View the FC type. The readout is identical to the FC 300 Series power field of the type code definition, characters 7-10.

15-42 Voltage

Option:**Function:**

View the FC type. The readout is identical to the FC 300 Series power field of the type code definition, characters 11-12.

15-43 Software Version

Option:**Function:**

View the combined SW version (or 'package version') consisting of power SW and control SW.

15-44 Ordered Typecode String

Option:**Function:**

View the type code string used for re-ordering the adjustable frequency drive in its original configuration.

15-45 Actual Typecode String

Option:**Function:**

View the actual type code string.

15-46 Adjustable Frequency Drive Ordering No.

Option:**Function:**

View the 8-digit ordering number used for re-ordering the adjustable frequency drive in its original configuration.

15-47 Power Card Ordering No.**Option:****Function:**

View the power card ordering number.

15-48 LCP ID No.**Option:****Function:**

View the LCP ID number.

15-49 SW ID Control Card**Option:****Function:**

View the control card software version number.

15-50 SW ID Power Card**Option:****Function:**

View the power card software version number.

15-51 Adjustable Frequency Drive Serial Number**Option:****Function:**

View the adjustable frequency drive serial number.

15-53 Power Card Serial Number**Option:****Function:**

View the power card serial number.

2.16.7. Option Ident. 15-6*

This read-only parameter group contains information about the hardware and software configuration of the options installed in slots A, B C0 and C1.

15-60 Option Mounted**Option:****Function:**

View the installed option type.

15-61 Option SW Version

Option: **Function:**
View the installed option software version.

15-62 Option Ordering No.

Option: **Function:**
Shows the ordering number for the installed options.

15-63 Option Serial No.

Option: **Function:**
View the installed option serial number.

2.16.8. Parameter Info, 15-9*

Parameter lists

15-92 Defined Parameters

Array [1000]

0* [0 - 9999] View a list of all defined parameters in the adjustable frequency drive. The list ends with 0.

15-93 Modified Parameters

Array [1000]

0* [0 - 9999] View a list of the parameters that have been changed from their default settings. The list ends with 0. Changes may not be visible until up to 30 seconds after implementation.

15-99 Parameter Metadata

Array [30]

0* [0 - 9999] This parameter contains data used by the MCT10 software tool.

2.17. Parameters: Data Read-outs

2

2.17.1. 16-** Data Readouts

Parameter group for data readouts, such as current references, voltages, control, alarm, warning and status words.

2.17.2. 16-0* General Status

Parameters for reading the general status, such as the calculated reference, the active control word and status.

16-00 Control Word

| | |
|---------------|---|
| Range: | Function: |
| 0* [0 - FFFF] | View the control word sent from the adjustable frequency drive via the serial communication port in hex code. |

16-01 Reference [Unit]

| | |
|------------------------------------|---|
| Range: | Function: |
| 0.000* [-999999.000 999999.000] | - View the present reference value applied on impulse or analog basis in the unit resulting from the configuration selected in par. 1-00 (Hz, Nm or rpm). |

16-02 -200.0 - 200.0 %

| | |
|---------------|--|
| Range: | Function: |
| 0.0%* [] | View the total reference. The total reference is the sum of the digital, analog, preset, bus and freeze references, plus catch-up and slow-down. |

16-03 Status Word

| | |
|---------------|--|
| Range: | Function: |
| 0* [0 - FFFF] | View the status word sent from the adjustable frequency drive via the serial communication port in hex code. |

16-05 Main Actual Value [%]

| | |
|---------------------|---|
| Range: | Function: |
| 0%* [-100 to +100%] | View the two-byte word sent with the status word to the bus master reporting the main actual value. |

16-09 Custom Readout

| | |
|----------------------------------|--|
| Range: | Function: |
| 0.00 [x.xx - x.xx unit] unit* | View the value of custom readout from par. 0-30 to par. 0-32 |

2.17.3. 16-1* Motor Status

Parameters for reading the motor status values.

16-10 Power [kW]

| | |
|---------------------------|--|
| Range: | Function: |
| 0.0kW* [0.0 - 1,000.0 kW] | View the motor power in kW. The value shown is calculated on the basis of the actual motor voltage and motor current. The value is filtered, and therefore approx. 30 ms may pass from when an input value changes to when the data readout values change. |

16-11 Power [HP]

| | |
|----------------------------------|--|
| Range: | Function: |
| 0.00 [0.00 - 1,000.00 HP] hp* | View the motor power in HP. The value shown is calculated on the basis of the actual motor voltage and motor current. The value is filtered, and therefore approx. 30 ms may pass from when an input value changes to when the data readout values change. |

16-12 Motor Voltage

| | |
|--------------------------|---|
| Range: | Function: |
| 0.0 V* [0.0 - 6,000.0 V] | View the motor voltage, which is a calculated value used for controlling the motor. |

16-13 Motor Frequency

| | |
|--------------------------|--|
| Range: | Function: |
| 0.0 Hz* [0.0 6,500.0 Hz] | View the motor frequency, without resonance damping. |

16-14 Motor Current

| | |
|-------------------------|--|
| Range: | Function: |
| 0.00 A* [0.00 - 0.00 A] | View the motor current measured as a mean value, IRMS. The value is filtered, and thus approx. 30 ms may pass from when an input value changes to when the data readout values change. |

16-15 Frequency [%]

Range:

0.00%* [0.00 - 0.00 %]

Function:

View a two-byte word reporting the actual motor frequency (without resonance damping) as a percentage (scale 0000-4000 Hex) of par. 4-19 *Max. Output Frequency*. Set par. 9-16 index 1 to send it with the status word instead of the MAV.

16-16 Torque

Range:

0.0 Nm* [-3,000.0 - +3,000.0 Nm]

Function:

View the torque value with sign, applied to the motor shaft. Linearity is not exact between 160% motor current and torque in relation to the rated torque. Some motors supply more than 160% torque. Consequently, the minimum and maximum values will depend on the maximum motor current, as well as the motor type being used. The value is filtered, and thus approx. 30 ms may pass from when an input changes value to when the data readout values change.

16-17 Speed [rpm]

Range:

0 rpm* [0 - 0 rpm]

Function:

View the actual motor rpm. Motor rpm is estimated in open-loop or closed-loop process control, and it is measured in speed closed-loop modes.

16-18 Motor Thermal

Range:

0 %* [0 - 100 %]

Function:

View the calculated thermal load on the motor. The cut-out limit is 100%. The basis for calculation is the ETR function selected in par.1-90.

16-19 KTY Sensor Temperature

Range:

32° F [32°-xxx° F [0°-xxx° [0° C]* C]]

Function:

Returning the actual temperature on the KTY sensor built into the motor.
See par. 1-9*.

16-20 Motor Angle

Range:

0* [0 - 65535]

Function:

View the current encoder/resolver angle offset relative to the index position. The value range of 0-65535 corresponds to 0-2*pi (radians).

16-22 Torque [%]**Range:**

0%* [-200 - 200%]

Function:

Value shown is the torque as a percentage of nominal torque, with sign, applied to the motor shaft.

2.17.4. 16-3* Drive Status

Parameters for reporting the status of the adjustable frequency drive.

16-30 DC Link Voltage**Range:**

0V* [0 - 10000 V]

Function:

View a measured value. The value is filtered, and thus approx. 30 ms may pass from when an input value changes to when the data readout value changes.

16-32 Braking Energy/sec.**Range:**0.000 [0.000 - 0.000 kW]
kW***Function:**

View the braking energy transmitted to an external brake resistor, stated as an instantaneous value.

16-33 Braking Energy/2 min**Range:**0.000 [0.000 - 500,000 kW]
kW***Function:**

View the braking energy transmitted to an external brake resistor. The mean power is calculated on an average basis for the most recent 120 seconds.

16-34 Heatsink Temp.**Range:**32° F [32°-491° F [0°-255 °
[0° C]* C]]**Function:**

View the adjustable frequency drive heatsink temperature. The cut-out limit is 203° ± 9° F [90° ± 5° C], and the motor cuts back in at 158° ± 9° F [60° ± 5°C].

16-35 Inverter Thermal**Range:**

0 %* [0 - 0 %]

Function:

View the percentage load on the inverter.

16-36 Inv. Nom. Current**Range:**

A* [0.01 - 10,000.00 A]

Function:

View the inverter nominal current, which should match the nameplate data on the connected motor. The data is used for motor protection, calculating torque, etc.

16-37 Inv. Max. Current**Range:**

A* [0.01 - 10,000.00 A]

Function:

View the inverter maximum current, which should match the nameplate data on the connected motor. The data is used for motor protection, calculating torque, etc.

16-38 SL Controller State**Range:**

0* [0 - 100]

Function:

View the state of the event under execution by the SL controller.

16-39 Control Card Temp.**Range:**32° F [32°-212° F [0°-100°
[0° C]* C]]**Function:**

View the temperature on the control card, stated in °C.

16-40 Logging Buffer Full**Option:**

[0] * No

Function:

[1] Yes

View whether the logging buffer is full (see par. 15-1*). The logging buffer will never be full when par. 15-13 *Logging Mode* is set to *Log always* [0].**2.17.5. 16-5* Ref. & Feedb.**

Parameters for reporting the reference and feedback input.

16-50 External Reference**Range:**

0.0* [-200.0 - 200.0]

Function:

View the total reference, the sum of digital, analog, preset, bus and freeze references, plus catch-up and slow-down.

16-51 Pulse Reference**Range:**

0.0* [-200 - 200]

Function:

View the reference value from programmed digital input(s). The readout can also reflect the impulses from an incremental encoder.

16-52 Feedback [Unit]**Range:**0.0* [-999999.999
999999.999]**Function:**

- View the feedback unit resulting from the selection of unit and scaling in par. 3-00, 3-01, 3-02 and 3-03.

16-53 DigiPot Reference

Range: 0.0* [-200 - 200] **Function:** View the contribution of the digital potentiometer to the actual reference.

2.17.6. 16-6* Inputs and Outputs

Parameters for reporting the digital and analog IO ports.

16-60 Digital Input

Range: 0* [0 - 63] **Function:** View the signal states from the active digital inputs. Example: Input 18 corresponds to bit no. 5, '0' = no signal, '1' = connected signal.

| | |
|-----------|----------------------------------|
| Bit 0 | Digital input term. 33 |
| Bit 1 | Digital input term. 32 |
| Bit 2 | Digital input term. 29 |
| Bit 3 | Digital input term. 27 |
| Bit 4 | Digital input term. 19 |
| Bit 5 | Digital input term. 18 |
| Bit 6 | Digital input term. 37 |
| Bit 7 | Digital input GP I/O term. X30/4 |
| Bit 8 | Digital input GP I/O term. X30/3 |
| Bit 9 | Digital input GP I/O term. X30/2 |
| Bit 10-63 | Reserved for future terminals |

16-61 Terminal 53 Switch Setting

Option: [0] * Current **Function:** View the setting of input terminal 53. Current = 0; Voltage = 1.
 [1] Voltage

16-62 Analog Input 53

Range: 0.000* [-20.000 - 20.000] **Function:** View the actual value at input 53.

16-63 Terminal 54 Switch Setting

Option: [0] * Current **Function:** View the setting of input terminal 54. Current = 0; Voltage = 1.
 [1] Voltage

16-64 Analog Input 54

| | |
|---------------------------|------------------------------------|
| Range: | Function: |
| 0.000* [-20.000 - 20.000] | View the actual value at input 54. |

16-65 Analog Output 42 [mA]

| | |
|-------------------------|---|
| Range: | Function: |
| 0.000* [0.000 - 30.000] | View the actual value at output 42 in mA. The value shown reflects the selection in par. 06-50. |

16-66 Digital Output [bin]

| | |
|---------------|---|
| Range: | Function: |
| 0* [0 - 115] | View the binary value of all digital outputs. |

16-67 Freq. Input 29 [Hz]

| | |
|---------------|--|
| Range: | Function: |
| 0* [0 - 0] | View the actual frequency rate on terminal 29. |

16-68 Freq. Input #33 [Hz]

| | |
|-----------------|--|
| Range: | Function: |
| 0* [0 - 130000] | View the actual value of the frequency applied at terminal 33 as an impulse input. |

16-69 Pulse Output #27 [Hz]

| | |
|----------------|--|
| Range: | Function: |
| 0* [0 - 40000] | View the actual value of pulses applied to terminal 27 in digital output mode. |

16-70 Pulse Output #29 [Hz]

| | |
|----------------|--|
| Range: | Function: |
| 0* [0 - 40000] | View the actual value of pulses at terminal 29 in digital output mode. This parameter is available for the FC 302 only. |

16-71 Relay Output [bin]

| | |
|---------------|----------------------------------|
| Range: | Function: |
| 0* [0 - 31] | View the settings of all relays. |

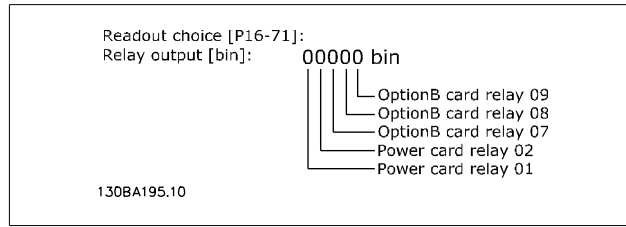

16-72 Counter A

Range:
 0* [-2147483648 -2147483647]

Function:
 View the present value of counter A. Counters are useful as comparator operands; see par. 13-10. The value can be reset or changed either via digital inputs (parameter group 5-1*) or by using an SLC action (par. 13-52).

16-73 Counter B

Range:
 0* [-2147483648 -2147483647]

Function:
 View the present value of counter B. Counters are useful as comparator operands (par. 13-10). The value can be reset or changed either via digital inputs (parameter group 5-1*) or by using an SLC action (par. 13-52).

16-74 Precise Stop Counter

Range:
 0* [0 - 2147483647]

Function:
 Returns the current counter value of precise counter (par. 1-84).

16-75 Analog In X30/11

Range:
 0.000* [0.000 - 0.000]

Function:
 View the actual value at input X30/11 of MCB 101.

16-76 Analog In X30/12

Range:
 0.000* [0.000 - 0.000]

Function:
 View the actual value at input X30/12 of MCB 101.

16-77 Analog Out X30/8 16-77 [mA]

Range:
 0.000* [0.000 - 0.000]

Function:
 View the actual value at input X30/8 in mA.

2.17.7. 16-8* Ser. Com. Bus & FC Port

Parameters for reporting the BUS references and control words.

16-80 Ser. Com. Bus CTW 1**Range:**

0* [0 - 65535]

Function:

View the two-byte control word (CTW) received from the bus master. Interpretation of the control word depends on the serial communication option installed and the control word profile selected in par. 8-10.

For more information, please refer to the relevant serial communication bus manual.

16-82 Ser. com. bus REF 1**Range:**

0* [-200 - 200]

Function:

View the two-byte word sent with the control word from the bus master to set the reference value.

For more information, please refer to the relevant serial communication bus manual.

16-84 Comm. Option STW**Range:**

0* [0 - 65535]

Function:

View the extended ser. com. bus option status word.

For more information, please refer to the relevant serial communication bus manual.

16-85 FC Port CTW 1**Range:**

0* [0 - 65535]

Function:

View the two-byte control word (CTW) received from the bus master. Interpretation of the control word depends on the serial communication option installed and the control word profile selected in par. 8-10.

16-86 FC Port REF 1**Range:**

0* [0 - 0]

Function:

View the two-byte status word (STW) sent to the bus master. Interpretation of the status word depends on the serial communication bus option installed and the control word profile selected in par. 8-10.

2.17.8. 16-9* Diagnosis Readout

Parameters displaying alarm, warning and extended status words.

16-90 Alarm Word**Range:**

0* [0 - FFFFFFFF]

Function:

View the alarm word sent via the serial communication port in hex code.

16-90 Alarm Word 2**Range:**

0* [0 - FFFFFFFF]

Function:

View the alarm word sent via the serial communication port in hex code.

16-92 Warning Word**Range:**

0* [0 - FFFFFFFF]

Function:

View the warning word sent via the serial communication port in hex code.

16-93 Warning Word 2**Range:**

0* [0 - FFFF]

Function:

View the warning word sent via the serial communication port in hex code.

16-94 Ext. Status Word**Range:**

0* [0 - FFFF]

Function:

Returns the extended warning word sent via the serial communication port in hex code.

2.18. Parameters: Encoder Input

2

2.18.1. 17-** Motor Feedb. Option

Additional parameters to configure the Encoder (MCB102) or the Resolver (MCB103) Feedback Option.

2.18.2. 17-1* Inc. Enc. Interface

Parameters in this group configure the incremental interface of the MCB102 option. Note that both the incremental and absolute interfaces are active at the same time.

17-10 Signal Type

| Option: | Function: |
|--------------------------------|---|
| [0] None | |
| [1] * RS422 (5V TTL/ linedrv.) | |
| [2] Sinusoidal 1Vpp | Select the incremental type (A/B channel) of the encoder in use. Find the information on the encoder data sheet. Select <i>None</i> [0] if the feedback sensor is an absolute encoder only. This parameter cannot be adjusted while the motor is running. |

17-11 Resolution (PPR)

| Range: | Function: |
|--------------------|--|
| 1024* [10 - 10000] | Enter the resolution of the incremental track, i.e., the number of pulses or periods per revolution. This parameter cannot be adjusted while the motor is running. |

2.18.3. 17-2* Abs. Enc. Interface

Parameters in this group configure the absolute interface of the MCB102 option. Note that both the incremental and absolute interfaces are active at the same time.

17-20 Protocol Selection

| Option: | Function: |
|---------------|--|
| [0] * None | |
| [1] HIPERFACE | |
| [2] EnDat | |
| [4] SSI | Select <i>HIPERFACE</i> [1] if the encoder is absolute only. Select <i>None</i> [0] if the feedback sensor is an incremental encoder only. This parameter cannot be adjusted while the motor is running. |

17-21 Resolution (Positions/Rev)

| Option: | Function: |
|--------------------------------|--|
| [512] 512 | |
| [1024] 1024 | |
| [2048] 2048 | |
| [4096] 4096 | |
| [8192] SSI 4 - 8192 | |
| [16384] 16384 | |
| [32768] HIPERFACE 512 32768 | - Select the resolution of the absolute encoder, i.e., the number of counts per revolution. This parameter cannot be adjusted while the motor is running. The value depends on the setting in par. 17-20. |

17-24 SSI Data Length

| Range: | Function: |
|---------------|--|
| 13* [13 - 25] | Set the number of bits for the SSI telegram. Choose 13 bits for single-turn encoders, and 25 bits for multi-turn encoders. |

17-25 Clock Rate

| Range: | Function: |
|-----------------------------|--|
| 260 [100 - 260 kHz] kHz* | Set the SSI clock rate. The clock rate must be reduced with long encoder cables. |

17-26 SSI Data Format

| Option: | Function: |
|-----------------|--|
| [0] * Gray Code | |
| [1] Binary Code | Set the data format of the SSI data. Choose between Gray or Binary format. |

17-34 HIPERFACE Baud rate

| Option: | Function: |
|------------|--|
| [0] 600 | |
| [1] 1200 | |
| [2] 2400 | |
| [3] 4800 | |
| [4] * 9600 | |
| [5] 19200 | |
| [6] 38400 | Select the baud rate of the attached encoder. This parameter cannot be adjusted while the motor is running. The parameter is only accessible when par. 17-20 is set to HIPERFACE [1]. |

2.18.4. 17-5* Resolver Interface

Parameter group 17-5* is used for setting parameters for the MCB 103 resolver option. The resolver feedback is usually used for motor feedback from permanent magnet motors, with par. 1-01 set to flux with motor feedback. Resolver parameters cannot be adjusted while the motor is running.

17-50 Resolver Poles

| | |
|---------------|--|
| Range: | Function: |
| 2* [2-2] | Set the number of poles on the resolver. The value is stated in the data sheet for resolvers. |

17-51 Resolver Input Voltage

| | |
|----------------------|---|
| Range: | Function: |
| 7.0 V* [4.0 - 8.0 V] | Set the input voltage to the resolver. The voltage is stated as an RMS value. The value is stated in the data sheet for resolvers. |

17-52 Resolver Input Frequency

| | |
|-------------------------------|--|
| Range: | Function: |
| 10.0 [2.0 - 15.0 kHz] kHz* | Set the input frequency to the resolver. The value is stated in the data sheet for resolvers. |

17-53 Resolver Transformation Ratio

| | |
|------------------|---|
| Range: | Function: |
| 0.5* [0.1 - 1.1] | Set the transformation ratio for the resolver. The transformation ration is: |
| | $T_{ratio} = \frac{V_{Out}}{V_{In}}$ |
| | The value is stated in the data sheet for resolvers. |

17-59 Resolver Interface

| | |
|----------------|---|
| Option: | Function: |
| [0] * Disabled | |
| [1] Enabled | Activate the MCB 103 resolver option when the resolver parameters are selected. To avoid damage to resolvers, par. 17-50 through par. 17-53 must be adjusted before activating this parameter. |

2.18.5. 17-6* Monitoring and Application

This parameter group is used for selecting additional functions when the MCB 102 Encoder option or MCB 103 Resolver option is fitted into option slot B as speed feedback. Monitoring and application parameters cannot be adjusted while the motor is running.

17-60 Encoder Positive Direction

| Option: | Function: |
|-----------------------|---|
| [0] * Clockwise | |
| [1] Counter-clockwise | Change the detected encoder rotation direction without changing the wiring to the encoder. This parameter cannot be adjusted while the motor is running. |

2**17-61 Encoder Signal Monitoring**

| Option: | Function: |
|----------------|---|
| [0] Disabled | |
| [1] * Warning | |
| [2] Trip | Select which reaction the adjustable frequency drive should take in case a faulty encoder signal is detected. The encoder function in par. 17-61 is an electrical check of the hardware circuit in the encoder system. |

2.19. Parameter lists

2

FC Series

All = valid for FC 301 and FC 302 series

01 = valid for FC 301 only

02 = valid for FC 302 only

Changes during operation

"TRUE" means that the parameter can be changed while the adjustable frequency drive is in operation, and "FALSE" means that the adjustable frequency drive must be stopped before a change can be made.

4-Set-up

'All set-ups': the parameter can be set individually in each of the four set-ups, i.e., one single parameter can have four different data values.

'1 set-up': the data value will be the same in all set-ups.

Conversion index

This number refers to a conversion figure used when writing or reading by means of an adjustable frequency drive.

| | | | | | | | | | | | | | | | |
|---------------------|-----|------|-------------|--------|-------|------|-----|----|---|-----|------|------|-------|--------|----------|
| Conv. index | 100 | 67 | 6 | 5 | 4 | 3 | 2 | 1 | 0 | -1 | -2 | -3 | -4 | -5 | -6 |
| Conv. factor | 1 | 1/60 | 100000 0 | 100000 | 10000 | 1000 | 100 | 10 | 1 | 0.1 | 0.01 | 0.00 | 0.000 | 0.0000 | 0.000001 |

| Data type | Description | Type |
|-----------|--------------------------------------|--------|
| 2 | Integer 8 | Int8 |
| 3 | Integer 16 | Int16 |
| 4 | Integer 32 | Int32 |
| 5 | Unsigned 8 | UInt8 |
| 6 | Unsigned 16 | UInt16 |
| 7 | Unsigned 32 | UInt32 |
| 9 | Visible String | VisStr |
| 33 | Normalized value 2 bytes | N2 |
| 35 | Bit sequence of 16 boolean variables | V2 |
| 54 | Time difference w/o date | TimD |

2.19.1.1. 0-**- Operation/Display

| Par. No. # | Parameter description | Default value | 4-set-up | FC 302 only | Change during operation | Conversion index | Type |
|-------------------------------|------------------------------------|--------------------------|-------------|-------------|-------------------------|------------------|--------|
| 0-0* Basic Settings | | | | | | | |
| 0-01 | Language | [0] English | 1 set-up | | TRUE | - | Uint8 |
| 0-02 | Motor Speed Unit | [0] RPM | 2 set-ups | | FALSE | - | Uint8 |
| 0-03 | Regional Settings | [0] International | 2 set-ups | | FALSE | - | Uint8 |
| 0-04 | Operating State at Power-up (Hand) | [1] Forced stop, ref=old | All set-ups | | TRUE | - | Uint8 |
| 0-1* Set-up Operations | | | | | | | |
| 0-10 | Active Set-up | [1] Set-up 1 | 1 set-up | | TRUE | - | Uint8 |
| 0-11 | Edit Set-up | [1] Set-up 1 | All set-ups | | TRUE | - | Uint8 |
| 0-12 | This Set-up Linked to | [0] Not linked | All set-ups | | FALSE | - | Uint8 |
| 0-13 | Readout: Linked Set-ups | 0 N/A | All set-ups | | FALSE | 0 | Uint16 |
| 0-14 | Readout: Edit Set-ups / Channel | 0 N/A | All set-ups | | TRUE | 0 | Int32 |
| 0-2* LCP Display | | | | | | | |
| 0-20 | Display Line 1.1 Small | 1617 | All set-ups | | TRUE | - | Uint16 |
| 0-21 | Display Line 1.2 Small | 1614 | All set-ups | | TRUE | - | Uint16 |
| 0-22 | Display Line 1.3 Small | 1610 | All set-ups | | TRUE | - | Uint16 |
| 0-23 | Display Line 2 Large | 1613 | All set-ups | | TRUE | - | Uint16 |
| 0-24 | Display Line 3 Large | 1602 | All set-ups | | TRUE | - | Uint16 |
| 0-25 | My Personal Menu | ExpressionLimit | 1 set-up | | TRUE | 0 | Uint16 |
| 0-3* LCP Cust. Readout | | | | | | | |
| 0-30 | Unit for User-defined Readout | [0] None | All set-ups | | TRUE | - | Uint8 |
| 0-31 | Min Value of User-defined Readout | 0.00 CustomReadoutUnit | All set-ups | | TRUE | -2 | Int32 |
| 0-32 | Max Value of User-defined Readout | 100.00 CustomReadoutUnit | All set-ups | | TRUE | -2 | Int32 |
| 0-4* LCP Keypad | | | | | | | |
| 0-40 | [Hand on] Key on LCP | [1] Enabled | All set-ups | | TRUE | - | Uint8 |
| 0-41 | [Off] Key on LCP | [1] Enabled | All set-ups | | TRUE | - | Uint8 |
| 0-42 | [Auto on] Key on LCP | [1] Enabled | All set-ups | | TRUE | - | Uint8 |
| 0-43 | [Reset] Key on LCP | [1] Enabled | All set-ups | | TRUE | - | Uint8 |
| 0-5* Copy/Save | | | | | | | |
| 0-50 | LCP Copy | [0] No copy | All set-ups | | FALSE | - | Uint8 |
| 0-51 | Set-up Copy | [0] No copy | All set-ups | | FALSE | - | Uint8 |
| 0-6* Password | | | | | | | |
| 0-60 | Main Menu Password | 100 N/A | 1 set-up | | TRUE | 0 | Int16 |
| 0-61 | Access to Main Menu w/o Password | [0] Full access | 1 set-up | | TRUE | - | Uint8 |
| 0-65 | Quick Menu Password | 200 N/A | 1 set-up | | TRUE | 0 | Int16 |
| 0-66 | Access to Quick Menu w/o Password | [0] Full access | 1 set-up | | TRUE | - | Uint8 |
| 0-67 | Bus Password Access | 0 N/A | All set-ups | | TRUE | 0 | Uint16 |

2

2.19.2. 1-**- Load/Motor

| Par. No. # | Parameter description | Default value | 4-set-up | FC 302 only | Change during operation | Conversion index | Type |
|---------------------------------|------------------------------------|-----------------------|-------------|-------------|-------------------------|------------------|--------|
| 1-0* General Settings | | | | | | | |
| 1-00 | Configuration Mode | null | All set-ups | | TRUE | - | Uint8 |
| 1-01 | Motor Control Principle | null | All set-ups | | FALSE | - | Uint8 |
| 1-02 | Flux Motor Feedback Source | [1] 24V encoder | All set-ups | x | FALSE | - | Uint8 |
| 1-03 | Torque Characteristics | [0] Constant torque | All set-ups | | TRUE | - | Uint8 |
| 1-04 | Overload Mode | [0] High torque | All set-ups | | FALSE | - | Uint8 |
| 1-05 | Local Mode Configuration | [2] As mode par. 1-00 | All set-ups | | TRUE | - | Uint8 |
| 1-1* Motor Selection | | | | | | | |
| 1-10 | Motor Construction | [0] Asynchron | All set-ups | | FALSE | - | Uint8 |
| 1-2* Motor Data | | | | | | | |
| 1-20 | Motor Power [kW] | ExpressionLimit | All set-ups | | FALSE | 1 | Uint32 |
| 1-21 | Motor Power [HP] | ExpressionLimit | All set-ups | | FALSE | -2 | Uint32 |
| 1-22 | Motor Voltage | ExpressionLimit | All set-ups | | FALSE | 0 | Uint16 |
| 1-23 | Motor Frequency | ExpressionLimit | All set-ups | | FALSE | 0 | Uint16 |
| 1-24 | Motor Current | ExpressionLimit | All set-ups | | FALSE | -2 | Uint32 |
| 1-25 | Motor Nominal Speed | ExpressionLimit | All set-ups | | FALSE | 67 | Uint16 |
| 1-26 | Motor Cont. Rated Torque | ExpressionLimit | All set-ups | | FALSE | -1 | Uint32 |
| 1-29 | Automatic Motor Adaptation (AMA) | [0] Off | All set-ups | | FALSE | - | Uint8 |
| 1-3* Addl. Motor Data | | | | | | | |
| 1-30 | Stator Resistance (Rs) | ExpressionLimit | All set-ups | | FALSE | -4 | Uint32 |
| 1-31 | Rotor Resistance (Rr) | ExpressionLimit | All set-ups | | FALSE | -4 | Uint32 |
| 1-33 | Stator Leakage Reactance (X1) | ExpressionLimit | All set-ups | | FALSE | -4 | Uint32 |
| 1-34 | Rotor Leakage Reactance (X2) | ExpressionLimit | All set-ups | | FALSE | -4 | Uint32 |
| 1-35 | Main Reactance (Xh) | ExpressionLimit | All set-ups | | FALSE | -4 | Uint32 |
| 1-36 | Iron Loss Resistance (Rfe) | ExpressionLimit | All set-ups | | FALSE | -3 | Uint32 |
| 1-37 | d-axis Inductance (Ld) | ExpressionLimit | All set-ups | x | FALSE | -4 | Int32 |
| 1-39 | Motor Poles | ExpressionLimit | All set-ups | | FALSE | 0 | Uint8 |
| 1-40 | Back EMF at 1000 RPM | ExpressionLimit | All set-ups | x | FALSE | 0 | Uint16 |
| 1-41 | Motor Angle Offset | 0 N/A | All set-ups | | FALSE | 0 | Int16 |
| 1-5* Load-Indep. Setting | | | | | | | |
| 1-50 | Motor Magnetization at Zero Speed | 100 % | All set-ups | | TRUE | 0 | Uint16 |
| 1-51 | Min Speed Normal Magnetizing [RPM] | ExpressionLimit | All set-ups | | TRUE | 67 | Uint16 |
| 1-52 | Min Speed Normal Magnetizing [Hz] | ExpressionLimit | All set-ups | | TRUE | -1 | Uint16 |
| 1-53 | Model Shift Frequency | ExpressionLimit | All set-ups | x | FALSE | -1 | Uint16 |
| 1-55 | U/f Characteristic - U | ExpressionLimit | All set-ups | | TRUE | -1 | Uint16 |
| 1-56 | U/f Characteristic - F | ExpressionLimit | All set-ups | | TRUE | -1 | Uint16 |

| Par. No. # | Parameter description | Default value | 4-set-up | FC 302 only | Change during operation | Conversion index | Type |
|---------------------------------|---------------------------------------|-----------------------|-------------|-------------|-------------------------|------------------|--------|
| 1-6* Load-Depend. Settg. | | | | | | | |
| 1-60 | Low Speed Load Compensation | 100 % | All set-ups | | TRUE | 0 | Int16 |
| 1-61 | High Speed Load Compensation | 100 % | All set-ups | | TRUE | 0 | Int16 |
| 1-62 | Slip Compensation | ExpressionLimit | All set-ups | | TRUE | 0 | Int16 |
| 1-63 | Slip Compensation Time Constant | ExpressionLimit | All set-ups | | TRUE | -2 | Uint16 |
| 1-64 | Resonance Dampening | 100 % | All set-ups | | TRUE | 0 | Uint16 |
| 1-65 | Resonance Dampening Time Constant | 5 ms | All set-ups | | TRUE | -3 | Uint8 |
| 1-66 | Min. Current at Low Speed | 100 % | All set-ups | x | TRUE | 0 | Uint8 |
| 1-67 | Load Type | [0] Passive load | All set-ups | x | TRUE | - | Uint8 |
| 1-68 | Minimum Inertia | ExpressionLimit | All set-ups | x | FALSE | -4 | Uint32 |
| 1-69 | Maximum Inertia | ExpressionLimit | All set-ups | x | FALSE | -4 | Uint32 |
| 1-7* Start Adjustments | | | | | | | |
| 1-71 | Start Delay | 0.0 s | All set-ups | | TRUE | -1 | Uint8 |
| 1-72 | Start Function | [2] Coast/delay time | All set-ups | | TRUE | - | Uint8 |
| 1-73 | Flying Start | [0] Disabled | All set-ups | | FALSE | - | Uint8 |
| 1-74 | Start Speed [RPM] | ExpressionLimit | All set-ups | | TRUE | 67 | Uint16 |
| 1-75 | Start Speed [Hz] | ExpressionLimit | All set-ups | | TRUE | -1 | Uint16 |
| 1-76 | Start Current | 0.00 A | All set-ups | | TRUE | -2 | Uint32 |
| 1-8* Stop Adjustments | | | | | | | |
| 1-80 | Function at Stop | [0] Coast | All set-ups | | TRUE | - | Uint8 |
| 1-81 | Min Speed for Function at Stop [RPM] | ExpressionLimit | All set-ups | | TRUE | 67 | Uint16 |
| 1-82 | Min Speed for Function at Stop [Hz] | ExpressionLimit | All set-ups | | TRUE | -1 | Uint16 |
| 1-83 | Precise Stop Function | [0] Precise ramp stop | All set-ups | | FALSE | - | Uint8 |
| 1-84 | Precise Stop Counter Value | 100000 N/A | All set-ups | | TRUE | 0 | Uint32 |
| 1-85 | Precise Stop Speed Compensation Delay | 10 ms | All set-ups | | TRUE | -3 | Uint8 |
| 1-9* Motor Temperature | | | | | | | |
| 1-90 | Motor Thermal Protection | [0] No protection | All set-ups | | TRUE | - | Uint8 |
| 1-91 | Motor External Fan | [0] No | All set-ups | | TRUE | - | Uint16 |
| 1-93 | Thermistor Resource | [0] None | All set-ups | | TRUE | - | Uint8 |
| 1-95 | KTY Sensor Type | [0] KTY Sensor 1 | All set-ups | x | TRUE | - | Uint8 |
| 1-96 | KTY Thermistor Resource | [0] None | All set-ups | x | TRUE | - | Uint8 |
| 1-97 | KTY Threshold level | 80 °C | 1 set-up | x | TRUE | 100 | Int16 |

2.19.3. 2-** Brakes

| Par. No. # | Parameter description | Default value | 4-set-up | FC 302 only | Change during operation | Conversion index | Type |
|---------------------------------|-----------------------------|-----------------|-------------|-------------|-------------------------|------------------|--------|
| 2-0* DC Brake | | | | | | | |
| 2-00 | DC Hold Current | 50 % | All set-ups | | TRUE | 0 | Uint8 |
| 2-01 | DC Brake Current | 50 % | All set-ups | | TRUE | 0 | Uint16 |
| 2-02 | DC Braking Time | 10.0 s | All set-ups | | TRUE | -1 | Uint16 |
| 2-03 | DC Brake Cut-in Speed [RPM] | ExpressionLimit | All set-ups | | TRUE | 67 | Uint16 |
| 2-04 | DC Brake Cut-in Speed [Hz] | ExpressionLimit | All set-ups | | TRUE | -1 | Uint16 |
| 2-1* Brake Energy Funct. | | | | | | | |
| 2-10 | Brake Function | null | All set-ups | | TRUE | - | Uint8 |
| 2-11 | Brake Resistor (ohm) | ExpressionLimit | All set-ups | | TRUE | -2 | Uint32 |
| 2-12 | Brake Power Limit (kW) | ExpressionLimit | All set-ups | | TRUE | 0 | Uint32 |
| 2-13 | Brake Power Monitoring | [0] Off | All set-ups | | TRUE | - | Uint8 |
| 2-15 | Brake Check | [0] Off | All set-ups | | TRUE | - | Uint8 |
| 2-16 | AC Brake Max. Current | 100.0 % | All set-ups | | TRUE | -1 | Uint32 |
| 2-17 | Over-voltage Control | [0] Disabled | All set-ups | | TRUE | - | Uint8 |
| 2-2* Mechanical Brake | | | | | | | |
| 2-20 | Release Brake Current | ImaxVLT (P1637) | All set-ups | | TRUE | -2 | Uint32 |
| 2-21 | Activate Brake Speed [RPM] | ExpressionLimit | All set-ups | | TRUE | 67 | Uint16 |
| 2-22 | Activate Brake Speed [Hz] | ExpressionLimit | All set-ups | | TRUE | -1 | Uint16 |
| 2-23 | Activate Brake Delay | 0.0 s | All set-ups | | TRUE | -1 | Uint8 |
| 2-24 | Stop Delay | 0.0 s | All set-ups | | TRUE | -1 | Uint8 |
| 2-25 | Brake Release Time | 0.20 s | All set-ups | | TRUE | -2 | Uint16 |
| 2-26 | Torque Ref | 0.00 % | All set-ups | | TRUE | -2 | Int16 |
| 2-27 | Torque Ramp Time | 0.2 s | All set-ups | | TRUE | -1 | Uint8 |
| 2-28 | Gain Boost Factor | 1.00 N/A | All set-ups | | TRUE | -2 | Uint16 |

2.19.4. 3-** Reference / Ramps

| Par. No. # | Parameter description | Default value | 4-set-up | FC 302 only | Change during operation | Conversion index | Type |
|------------------------------|-------------------------------------|---------------------------|-------------|-------------|-------------------------|------------------|--------|
| 3-0* Reference Limits | | | | | | | |
| 3-00 | Reference Range | null | All set-ups | | TRUE | - | Uint8 |
| 3-01 | Reference/Feedback Unit | null | All set-ups | | TRUE | - | Uint8 |
| 3-02 | Minimum Reference | 0 ReferenceFeedbackUnit | All set-ups | | TRUE | -3 | Int32 |
| 3-03 | Maximum Reference | ExpressionLimit | All set-ups | | TRUE | -3 | Int32 |
| 3-04 | Reference Function | [0] Sum | All set-ups | | TRUE | - | Uint8 |
| 3-1* References | | | | | | | |
| 3-10 | Preset Reference | 0.00 % | All set-ups | | TRUE | -2 | Int16 |
| 3-11 | Jog Speed [Hz] | ExpressionLimit | All set-ups | | TRUE | -1 | Uint16 |
| 3-12 | Catch up/slow-down Value | 0.00 % | All set-ups | | TRUE | -2 | Int16 |
| 3-13 | Reference Site | [0] Linked to Hand / Auto | All set-ups | | TRUE | - | Uint8 |
| 3-14 | Preset Relative Reference | 0.00 % | All set-ups | | TRUE | -2 | Int32 |
| 3-15 | Reference Resource 1 | null | All set-ups | | TRUE | - | Uint8 |
| 3-16 | Reference Resource 2 | null | All set-ups | | TRUE | - | Uint8 |
| 3-17 | Reference Resource 3 | null | All set-ups | | TRUE | - | Uint8 |
| 3-18 | Relative Scaling Reference Resource | [0] No function | All set-ups | | TRUE | - | Uint8 |
| 3-19 | Jog Speed [RPM] | ExpressionLimit | All set-ups | | TRUE | 67 | Uint16 |
| 3-4* Ramp 1 | | | | | | | |
| 3-40 | Ramp 1 Type | [0] Linear | All set-ups | | TRUE | - | Uint8 |
| 3-41 | Ramp 1 Ramp-up Time | ExpressionLimit | All set-ups | | TRUE | -2 | Uint32 |
| 3-42 | Ramp 1 Ramp-down Time | ExpressionLimit | All set-ups | | TRUE | -2 | Uint32 |
| 3-45 | Ramp 1 S-ramp Ratio at Accel. Start | 50 % | All set-ups | | TRUE | 0 | Uint8 |
| 3-46 | Ramp 1 S-ramp Ratio at Accel. End | 50 % | All set-ups | | TRUE | 0 | Uint8 |
| 3-47 | Ramp 1 S-ramp Ratio at Decel. Start | 50 % | All set-ups | | TRUE | 0 | Uint8 |
| 3-48 | Ramp 1 S-ramp Ratio at Decel. End | 50 % | All set-ups | | TRUE | 0 | Uint8 |
| 3-5* Ramp 2 | | | | | | | |
| 3-50 | Ramp 2 Type | [0] Linear | All set-ups | | TRUE | - | Uint8 |
| 3-51 | Ramp 2 Ramp-up Time | ExpressionLimit | All set-ups | | TRUE | -2 | Uint32 |
| 3-52 | Ramp 2 Ramp-down Time | ExpressionLimit | All set-ups | | TRUE | -2 | Uint32 |
| 3-55 | Ramp 2 S-ramp Ratio at Accel. Start | 50 % | All set-ups | | TRUE | 0 | Uint8 |
| 3-56 | Ramp 2 S-ramp Ratio at Accel. End | 50 % | All set-ups | | TRUE | 0 | Uint8 |
| 3-57 | Ramp 2 S-ramp Ratio at Decel. Start | 50 % | All set-ups | | TRUE | 0 | Uint8 |
| 3-58 | Ramp 2 S-ramp Ratio at Decel. End | 50 % | All set-ups | | TRUE | 0 | Uint8 |

| Par. No. # | Parameter description | Default value | 4-set-up | FC 302 only | Change during operation | Conversion index | Type |
|--------------------------------|-------------------------------------|-----------------|-------------|-------------|-------------------------|------------------|--------|
| 3-6* Ramp 3 | | | | | | | |
| 3-60 | Ramp 3 Type | [0] Linear | All set-ups | | TRUE | - | Uint8 |
| 3-61 | Ramp 3 Ramp-up Time | ExpressionLimit | All set-ups | | TRUE | -2 | Uint32 |
| 3-62 | Ramp 3 Ramp-down Time | ExpressionLimit | All set-ups | | TRUE | -2 | Uint32 |
| 3-65 | Ramp 3 S-ramp Ratio at Accel. Start | 50 % | All set-ups | | TRUE | 0 | Uint8 |
| 3-66 | Ramp 3 S-ramp Ratio at Accel. End | 50 % | All set-ups | | TRUE | 0 | Uint8 |
| 3-67 | Ramp 3 S-ramp Ratio at Decel. Start | 50 % | All set-ups | | TRUE | 0 | Uint8 |
| 3-68 | Ramp 3 S-ramp Ratio at Decel. End | 50 % | All set-ups | | TRUE | 0 | Uint8 |
| 3-7* Ramp 4 | | | | | | | |
| 3-70 | Ramp 4 Type | [0] Linear | All set-ups | | TRUE | - | Uint8 |
| 3-71 | Ramp 4 Ramp-up Time | ExpressionLimit | All set-ups | | TRUE | -2 | Uint32 |
| 3-72 | Ramp 4 Ramp-down Time | ExpressionLimit | All set-ups | | TRUE | -2 | Uint32 |
| 3-75 | Ramp 4 S-ramp Ratio at Accel. Start | 50 % | All set-ups | | TRUE | 0 | Uint8 |
| 3-76 | Ramp 4 S-ramp Ratio at Accel. End | 50 % | All set-ups | | TRUE | 0 | Uint8 |
| 3-77 | Ramp 4 S-ramp Ratio at Decel. Start | 50 % | All set-ups | | TRUE | 0 | Uint8 |
| 3-78 | Ramp 4 S-ramp Ratio at Decel. End | 50 % | All set-ups | | TRUE | 0 | Uint8 |
| 3-8* Other Ramps | | | | | | | |
| 3-80 | Jog Ramp Time | ExpressionLimit | All set-ups | | TRUE | -2 | Uint32 |
| 3-81 | Quick Stop Ramp Time | ExpressionLimit | 2 set-ups | | TRUE | -2 | Uint32 |
| 3-9* Digital Pot. meter | | | | | | | |
| 3-90 | Step Size | 0.10 % | All set-ups | | TRUE | -2 | Uint16 |
| 3-91 | Ramp Time | 1.00 s | All set-ups | | TRUE | -2 | Uint32 |
| 3-92 | Power Restore | [0] Off | All set-ups | | TRUE | - | Uint8 |
| 3-93 | Maximum Limit | 100 % | All set-ups | | TRUE | 0 | Int16 |
| 3-94 | Minimum Limit | -100 % | All set-ups | | TRUE | 0 | Int16 |
| 3-95 | Ramp Delay | 1.000 N/A | All set-ups | | TRUE | -3 | TimD |

2.19.5. 4-** Limits / Warnings

| Par. No. # | Parameter description | Default value | 4-set-up | FC 302 only | Change during operation | Conversion index | Type |
|------------------------------|------------------------------|-----------------------------------|-------------|-------------|-------------------------|------------------|--------|
| 4-1* Motor Limits | | | | | | | |
| 4-10 | Motor Speed Direction | null | All set-ups | | FALSE | - | Uint8 |
| 4-11 | Motor Speed Low Limit [RPM] | ExpressionLimit | All set-ups | | TRUE | 67 | Uint16 |
| 4-12 | Motor Speed Low Limit [Hz] | ExpressionLimit | All set-ups | | TRUE | -1 | Uint16 |
| 4-13 | Motor Speed High Limit [RPM] | ExpressionLimit | All set-ups | | TRUE | 67 | Uint16 |
| 4-14 | Motor Speed High Limit [Hz] | ExpressionLimit | All set-ups | | TRUE | -1 | Uint16 |
| 4-16 | Torque Limit Motor Mode | ExpressionLimit | All set-ups | | TRUE | -1 | Uint16 |
| 4-17 | Torque Limit Generator Mode | 100.0 % | All set-ups | | TRUE | -1 | Uint16 |
| 4-18 | Current Limit | ExpressionLimit | All set-ups | | TRUE | -1 | Uint32 |
| 4-19 | Max Output Frequency | 132.0 Hz | All set-ups | | FALSE | -1 | Uint16 |
| 4-2* Limit Factors | | | | | | | |
| 4-20 | Torque Limit Factor Source | [0] No function | All set-ups | | TRUE | - | Uint8 |
| 4-21 | Speed Limit Factor Source | [0] No function | All set-ups | | TRUE | - | Uint8 |
| 4-3* Motor Fb Monitor | | | | | | | |
| 4-30 | Motor Feedback Loss Function | [2] Trip | All set-ups | | TRUE | - | Uint8 |
| 4-31 | Motor Feedback Speed Error | 300 RPM | All set-ups | | TRUE | 67 | Uint16 |
| 4-32 | Motor Feedback Loss Timeout | 0.05 s | All set-ups | | TRUE | -2 | Uint16 |
| 4-5* Adj. Warnings | | | | | | | |
| 4-50 | Warning Current Low | 0.00 A | All set-ups | | TRUE | -2 | Uint32 |
| 4-51 | Warning Current High | ImaxVLT (P1637) | All set-ups | | TRUE | -2 | Uint32 |
| 4-52 | Warning Speed Low | 0 RPM | All set-ups | | TRUE | 67 | Uint16 |
| 4-53 | Warning Speed High | outputSpeedHighLimit (P413) | All set-ups | | TRUE | 67 | Uint16 |
| 4-54 | Warning Reference Low | -999999.999 N/A | All set-ups | | TRUE | -3 | Int32 |
| 4-55 | Warning Reference High | 999999.999 N/A | All set-ups | | TRUE | -3 | Int32 |
| 4-56 | Warning Feedback Low | -999999.999 ReferenceFeedbackUnit | All set-ups | | TRUE | -3 | Int32 |
| 4-57 | Warning Feedback High | 999999.999 ReferenceFeedbackUnit | All set-ups | | TRUE | -3 | Int32 |
| 4-58 | Missing Motor Phase Function | [1] On | All set-ups | | TRUE | - | Uint8 |
| 4-6* Speed Bypass | | | | | | | |
| 4-60 | Bypass Speed From [RPM] | ExpressionLimit | All set-ups | | TRUE | 67 | Uint16 |
| 4-61 | Bypass Speed From [Hz] | ExpressionLimit | All set-ups | | TRUE | -1 | Uint16 |
| 4-62 | Bypass Speed To [RPM] | ExpressionLimit | All set-ups | | TRUE | 67 | Uint16 |
| 4-63 | Bypass Speed To [Hz] | ExpressionLimit | All set-ups | | TRUE | -1 | Uint16 |

2.19.6. 5-** Digital In/Out

| Par. No. # | Parameter description | Default value | 4-set-up | FC 302 only | Change during operation | Conversion index | Type |
|------------------------------|---------------------------------|-----------------------------|-------------|-------------|-------------------------|------------------|--------|
| 5-0* Digital I/O mode | | | | | | | |
| 5-00 | Digital I/O Mode | [0] PNP | All set-ups | | FALSE | - | Uint8 |
| 5-01 | Terminal 27 Mode | [0] Input | All set-ups | | TRUE | - | Uint8 |
| 5-02 | Terminal 29 Mode | [0] Input | All set-ups | x | TRUE | - | Uint8 |
| 5-1* Digital Inputs | | | | | | | |
| 5-10 | Terminal 18 Digital Input | null | All set-ups | | TRUE | - | Uint8 |
| 5-11 | Terminal 19 Digital Input | null | All set-ups | | TRUE | - | Uint8 |
| 5-12 | Terminal 27 Digital Input | null | All set-ups | | TRUE | - | Uint8 |
| 5-13 | Terminal 29 Digital Input | null | All set-ups | x | TRUE | - | Uint8 |
| 5-14 | Terminal 32 Digital Input | [0] No operation | All set-ups | | TRUE | - | Uint8 |
| 5-15 | Terminal 33 Digital Input | [0] No operation | All set-ups | | TRUE | - | Uint8 |
| 5-16 | Terminal X30/2 Digital Input | [0] No operation | All set-ups | | TRUE | - | Uint8 |
| 5-17 | Terminal X30/3 Digital Input | [0] No operation | All set-ups | | TRUE | - | Uint8 |
| 5-18 | Terminal X30/4 Digital Input | [0] No operation | All set-ups | | TRUE | - | Uint8 |
| 5-19 | Terminal 37 Safe Stop | [1] Safe Stop Alarm | 1 set-up | x | TRUE | - | Uint8 |
| 5-3* Digital Outputs | | | | | | | |
| 5-30 | Terminal 27 Digital Output | null | All set-ups | | TRUE | - | Uint8 |
| 5-31 | Terminal 29 digital Output | null | All set-ups | x | TRUE | - | Uint8 |
| 5-32 | Term X30/6 Digi Out (MCB 101) | null | All set-ups | | TRUE | - | Uint8 |
| 5-33 | Term X30/7 Digi Out (MCB 101) | null | All set-ups | | TRUE | - | Uint8 |
| 5-4* Relays | | | | | | | |
| 5-40 | Function Relay | null | All set-ups | | TRUE | - | Uint8 |
| 5-41 | On Delay, Relay | 0.01 s | All set-ups | | TRUE | -2 | Uint16 |
| 5-42 | Off Delay, Relay | 0.01 s | All set-ups | | TRUE | -2 | Uint16 |
| 5-5* Pulse Input | | | | | | | |
| 5-50 | Term. 29 Low Frequency | 100 Hz | All set-ups | x | TRUE | 0 | Uint32 |
| 5-51 | Term. 29 High Frequency | 100 Hz | All set-ups | x | TRUE | 0 | Uint32 |
| 5-52 | Term. 29 Low Ref./Feedb. Value | 0.000 ReferenceFeedBackUnit | All set-ups | x | TRUE | -3 | Int32 |
| 5-53 | Term. 29 High Ref./Feedb. Value | ExpressionLimit | All set-ups | x | TRUE | -3 | Int32 |
| 5-54 | Pulse Filter Time Constant #29 | 100 ms | All set-ups | x | FALSE | -3 | Uint16 |
| 5-55 | Term. 33 Low Frequency | 100 Hz | All set-ups | | TRUE | 0 | Uint32 |
| 5-56 | Term. 33 High Frequency | 100 Hz | All set-ups | | TRUE | 0 | Uint32 |
| 5-57 | Term. 33 Low Ref./Feedb. Value | 0.000 ReferenceFeedBackUnit | All set-ups | | TRUE | -3 | Int32 |
| 5-58 | Term. 33 High Ref./Feedb. Value | ExpressionLimit | All set-ups | | TRUE | -3 | Int32 |
| 5-59 | Pulse Filter Time Constant #33 | 100 ms | All set-ups | | FALSE | -3 | Uint16 |

| Par. No. # | Parameter description | Default value | 4-set-up | FC 302 only | Change during operation | Conversion index | Type |
|-------------------------------|--------------------------------------|-----------------|-------------|-------------|-------------------------|------------------|--------|
| 5-6* Pulse Output | | | | | | | |
| 5-60 | Terminal 27 Pulse Output Variable | null | All set-ups | | TRUE | - | Uint8 |
| 5-62 | Pulse Output Max Freq #27 | ExpressionLimit | All set-ups | | TRUE | 0 | Uint32 |
| 5-63 | Terminal 29 Pulse Output Variable | null | All set-ups | x | TRUE | - | Uint8 |
| 5-65 | Pulse Output Max Freq #29 | ExpressionLimit | All set-ups | x | TRUE | 0 | Uint32 |
| 5-66 | Terminal X30/6 Pulse Output Variable | null | All set-ups | | TRUE | - | Uint8 |
| 5-68 | Pulse Output Max Freq #X30/6 | ExpressionLimit | All set-ups | | TRUE | 0 | Uint32 |
| 5-7* 24V Encoder Input | | | | | | | |
| 5-70 | Term 32/33 Pulses per Revolution | 1024 N/A | All set-ups | | FALSE | 0 | Uint16 |
| 5-71 | Term 32/33 Encoder Direction | [0] Clockwise | All set-ups | | FALSE | - | Uint8 |
| 5-9* Bus Controlled | | | | | | | |
| 5-90 | Digital & Relay Bus Control | 0 N/A | All set-ups | | TRUE | 0 | Uint32 |
| 5-93 | Pulse Out #27 Bus Control | 0.00 % | All set-ups | | TRUE | -2 | N2 |
| 5-94 | Pulse Out #27 Timeout Preset | 0.00 % | 1 set-up | | TRUE | -2 | Uint16 |
| 5-95 | Pulse Out #29 Bus Control | 0.00 % | All set-ups | x | TRUE | -2 | N2 |
| 5-96 | Pulse Out #29 Timeout Preset | 0.00 % | 1 set-up | x | TRUE | -2 | Uint16 |

2

2.19.7. 6-** Analog In/Out

| Par. No. # | Parameter description | Default value | 4-set-up | FC 302 only | Change during operation | Conversion index | Type |
|-----------------------------|-------------------------------------|----------------------|-------------|-------------|-------------------------|------------------|--------|
| 6-0* Analog I/O Mode | | | | | | | |
| 6-00 | Live Zero Timeout Time | 10 s | All set-ups | | TRUE | 0 | Uint8 |
| 6-01 | Live Zero Timeout Function | [0] Off | All set-ups | | TRUE | - | Uint8 |
| 6-1* Analog Input 1 | | | | | | | |
| 6-10 | Terminal 53 Low Voltage | 0.07 V | All set-ups | | TRUE | -2 | Int16 |
| 6-11 | Terminal 53 High Voltage | 10.00 V | All set-ups | | TRUE | -2 | Int16 |
| 6-12 | Terminal 53 Low Current | 0.14 mA | All set-ups | | TRUE | -5 | Int16 |
| 6-13 | Terminal 53 High Current | 20.00 mA | All set-ups | | TRUE | -5 | Int16 |
| 6-14 | Terminal 53 Low Ref./Feedb. Value | 0 ReferenceFeedbUnit | All set-ups | | TRUE | -3 | Int32 |
| 6-15 | Terminal 53 High Ref./Feedb. Value | ExpressionLimit | All set-ups | | TRUE | -3 | Int32 |
| 6-16 | Terminal 53 Filter Time Constant | 0.001 s | All set-ups | | TRUE | -3 | Uint16 |
| 6-2* Analog Input 2 | | | | | | | |
| 6-20 | Terminal 54 Low Voltage | 0.07 V | All set-ups | | TRUE | -2 | Int16 |
| 6-21 | Terminal 54 High Voltage | 10.00 V | All set-ups | | TRUE | -2 | Int16 |
| 6-22 | Terminal 54 Low Current | 0.14 mA | All set-ups | | TRUE | -5 | Int16 |
| 6-23 | Terminal 54 High Current | 20.00 mA | All set-ups | | TRUE | -5 | Int16 |
| 6-24 | Terminal 54 Low Ref./Feedb. Value | 0 ReferenceFeedbUnit | All set-ups | | TRUE | -3 | Int32 |
| 6-25 | Terminal 54 High Ref./Feedb. Value | ExpressionLimit | All set-ups | | TRUE | -3 | Int32 |
| 6-26 | Terminal 54 Filter Time Constant | 0.001 s | All set-ups | | TRUE | -3 | Uint16 |
| 6-3* Analog Input 3 | | | | | | | |
| 6-30 | Terminal X30/11 Low Voltage | 0.07 V | All set-ups | | TRUE | -2 | Int16 |
| 6-31 | Terminal X30/11 High Voltage | 10.00 V | All set-ups | | TRUE | -2 | Int16 |
| 6-34 | Term. X30/11 Low Ref./Feedb. Value | 0 ReferenceFeedbUnit | All set-ups | | TRUE | -3 | Int32 |
| 6-35 | Term. X30/11 High Ref./Feedb. Value | ExpressionLimit | All set-ups | | TRUE | -3 | Int32 |
| 6-36 | Term. X30/11 Filter Time Constant | 0.001 s | All set-ups | | TRUE | -3 | Uint16 |
| 6-4* Analog Input 4 | | | | | | | |
| 6-40 | Terminal X30/12 Low Voltage | 0.07 V | All set-ups | | TRUE | -2 | Int16 |
| 6-41 | Terminal X30/12 High Voltage | 10.00 V | All set-ups | | TRUE | -2 | Int16 |
| 6-44 | Term. X30/12 Low Ref./Feedb. Value | 0 ReferenceFeedbUnit | All set-ups | | TRUE | -3 | Int32 |
| 6-45 | Term. X30/12 High Ref./Feedb. Value | ExpressionLimit | All set-ups | | TRUE | -3 | Int32 |
| 6-46 | Term. X30/12 Filter Time Constant | 0.001 s | All set-ups | | TRUE | -3 | Uint16 |
| 6-5* Analog Output 1 | | | | | | | |
| 6-50 | Terminal 42 Output | null | All set-ups | | TRUE | - | Uint8 |
| 6-51 | Terminal 42 Output Min Scale | 0.00 % | All set-ups | | TRUE | -2 | Int16 |
| 6-52 | Terminal 42 Output Max Scale | 100.00 % | All set-ups | | TRUE | -2 | Int16 |
| 6-53 | Terminal 42 Output Bus Control | 0.00 % | All set-ups | | TRUE | -2 | N2 |
| 6-54 | Terminal 42 Output Timeout Preset | 0.00 % | 1 set-up | | TRUE | -2 | Uint16 |
| 6-6* Analog Output 2 | | | | | | | |
| 6-60 | Terminal X30/8 Output | null | All set-ups | | TRUE | - | Uint8 |
| 6-61 | Terminal X30/8 Min. Scale | 0.00 % | All set-ups | | TRUE | -2 | Int16 |
| 6-62 | Terminal X30/8 Max. Scale | 100.00 % | All set-ups | | TRUE | -2 | Int16 |

2.19.8. 7-**-** Controllers

| Par. No. # | Parameter description | Default value | 4-set-up | FC 302 only | Change during operation | Conversion index | Type |
|---------------------------------|--|-----------------|-------------|-------------|-------------------------|------------------|--------|
| 7-0* Speed PID Ctrl. | | | | | | | |
| 7-00 | Speed PID Feedback Source | null | All set-ups | | FALSE | - | Uint8 |
| 7-02 | Speed PID Proportional Gain | ExpressionLimit | All set-ups | | TRUE | -3 | Uint16 |
| 7-03 | Speed PID Integral Time | ExpressionLimit | All set-ups | | TRUE | -4 | Uint32 |
| 7-04 | Speed PID Differentiation Time | ExpressionLimit | All set-ups | | TRUE | -4 | Uint16 |
| 7-05 | Speed PID Diff. Gain Limit | 5.0 N/A | All set-ups | | TRUE | -1 | Uint16 |
| 7-06 | Speed PID Lowpass Filter Time | 10.0 ms | All set-ups | | TRUE | -4 | Uint16 |
| 7-08 | Speed PID Feed Forward Factor | 0 % | All set-ups | | FALSE | 0 | Uint16 |
| 7-2* Process Ctrl. Feedb | | | | | | | |
| 7-20 | Process CL Feedback 1 Resource | [0] No function | All set-ups | | TRUE | - | Uint8 |
| 7-22 | Process CL Feedback 2 Resource | [0] No function | All set-ups | | TRUE | - | Uint8 |
| 7-3* Process PID Ctrl. | | | | | | | |
| 7-30 | Process PID Normal/Inverse Control | [0] Normal | All set-ups | | TRUE | - | Uint8 |
| 7-31 | Process PID Anti Windup | [1] On | All set-ups | | TRUE | - | Uint8 |
| 7-32 | Process PID Controller Start Value | 0 RPM | All set-ups | | TRUE | 67 | Uint16 |
| 7-33 | Process PID Proportional Gain | 0.01 N/A | All set-ups | | TRUE | -2 | Uint16 |
| 7-34 | Process PID Integral Time | 10000.00 s | All set-ups | | TRUE | -2 | Uint32 |
| 7-35 | Process PID Differentiation Time | 0.00 s | All set-ups | | TRUE | -2 | Uint16 |
| 7-36 | Process PID Differentiation Gain Limit | 5.0 N/A | All set-ups | | TRUE | -1 | Uint16 |
| 7-38 | Process PID Feed Forward Factor | 0 % | All set-ups | | TRUE | 0 | Uint16 |
| 7-39 | On Reference Bandwidth | 5 % | All set-ups | | TRUE | 0 | Uint8 |

2.19.9. 8-** Comm. and Options

| Par. No. # | Parameter description | Default value | 4-set-up | FC 302 only | Change during operation | Conversion index | Type |
|---------------------------------|-------------------------------|---------------------------------|-------------|-------------|-------------------------|------------------|--------|
| 8-0* General Settings | | | | | | | |
| 8-01 | Control Site | [0] Digital and ctrl. word null | All set-ups | | TRUE | - | Uint8 |
| 8-02 | Control Word Source | | All set-ups | | TRUE | - | Uint8 |
| 8-03 | Control Word Timeout | 1.0 s | 1 set-up | | TRUE | -1 | Uint32 |
| 8-04 | Control Word Timeout Function | [0] Off | 1 set-up | | TRUE | - | Uint8 |
| 8-05 | End-of-Timeout Function | [1] Resume set-up | 1 set-up | | TRUE | - | Uint8 |
| 8-06 | Reset Control Word Timeout | [0] Do not reset | All set-ups | | TRUE | - | Uint8 |
| 8-07 | Diagnosis Trigger | [0] Disable | 2 set-ups | | TRUE | - | Uint8 |
| 8-1* Ctrl. Word Settings | | | | | | | |
| 8-10 | Control Word Profile | [0] FC profile | All set-ups | | TRUE | - | Uint8 |
| 8-13 | Configurable Status Word STW | [1] Profile Default | All set-ups | | TRUE | - | Uint8 |
| 8-3* FC Port Settings | | | | | | | |
| 8-30 | Protocol | [0] FC | 1 set-up | | TRUE | - | Uint8 |
| 8-31 | Address | 1 N/A | 1 set-up | | TRUE | 0 | Uint8 |
| 8-32 | FC Port Baud Rate | [2] 9600 Baud | 1 set-up | | TRUE | - | Uint8 |
| 8-35 | Minimum Response Delay | 10 ms | All set-ups | | TRUE | -3 | Uint16 |
| 8-36 | Max Response Delay | 5000 ms | 1 set-up | | TRUE | -3 | Uint16 |
| 8-37 | Max Inter-Char Delay | 25 ms | 1 set-up | | TRUE | -3 | Uint16 |
| 8-4* FC MC protocol set | | | | | | | |
| 8-40 | Telegram selection | [1] Standard telegram 1 | 2 set-ups | | TRUE | - | Uint8 |
| 8-5* Digital/Bus | | | | | | | |
| 8-50 | Coasting Select | [3] Logic OR | All set-ups | | TRUE | - | Uint8 |
| 8-51 | Quick Stop Select | [3] Logic OR | All set-ups | | TRUE | - | Uint8 |
| 8-52 | DC Brake Select | [3] Logic OR | All set-ups | | TRUE | - | Uint8 |
| 8-53 | Start Select | [3] Logic OR | All set-ups | | TRUE | - | Uint8 |
| 8-54 | Reverse Select | [3] Logic OR | All set-ups | | TRUE | - | Uint8 |
| 8-55 | Set-up Select | [3] Logic OR | All set-ups | | TRUE | - | Uint8 |
| 8-56 | Preset Reference Select | [3] Logic OR | All set-ups | | TRUE | - | Uint8 |
| 8-9* Bus Jog | | | | | | | |
| 8-90 | Bus Jog 1 Speed | 100 RPM | All set-ups | | TRUE | 67 | Uint16 |
| 8-91 | Bus Jog 2 Speed | 200 RPM | All set-ups | | TRUE | 67 | Uint16 |

2.19.10. 9-** Profibus

| Par. No. # | Parameter description | Default value | 4-set-up | FC 302 only | Change during operation | Conver- sion index | Type |
|---------------|---------------------------|--------------------------|-------------|----------------|----------------------------|-----------------------|-----------|
| 9-00 | Setpoint | 0 N/A | All set-ups | | TRUE | 0 | Uint16 |
| 9-07 | Actual Value | 0 N/A | All set-ups | | FALSE | 0 | Uint16 |
| 9-15 | PCD Write Configuration | ExpressionLimit | 2 set-ups | | TRUE | - | Uint16 |
| 9-16 | PCD Read Configuration | ExpressionLimit | 2 set-ups | | TRUE | - | Uint16 |
| 9-18 | Node Address | 126 N/A | 1 set-up | | TRUE | 0 | Uint8 |
| 9-22 | Telegram Selection | [108] PPO 8 | 1 set-up | | TRUE | - | Uint8 |
| 9-23 | Parameters for Signals | 0 | All set-ups | | TRUE | - | Uint16 |
| 9-27 | Parameter Edit | [1] Enabled | 2 set-ups | | FALSE | - | Uint16 |
| 9-28 | Process Control | [1] Enable cyclic master | 2 set-ups | | FALSE | - | Uint8 |
| 9-31 | Safe Address | 0 N/A | 1 set-up | | TRUE | 0 | Uint16 |
| 9-44 | Fault Message Counter | 0 N/A | All set-ups | | TRUE | 0 | Uint16 |
| 9-45 | Fault Code | 0 N/A | All set-ups | | TRUE | 0 | Uint16 |
| 9-47 | Fault Number | 0 N/A | All set-ups | | TRUE | 0 | Uint16 |
| 9-52 | Fault Situation Counter | 0 N/A | All set-ups | | TRUE | 0 | Uint16 |
| 9-53 | Profibus Warning Word | 0 N/A | All set-ups | | TRUE | 0 | Uint16 |
| 9-63 | Actual Baud Rate | 0 N/A | All set-ups | | TRUE | 0 | V2 |
| 9-64 | Device Identification | [255] No baud rate found | All set-ups | | TRUE | - | Uint8 |
| 9-65 | Profile Number | 0 N/A | All set-ups | | TRUE | 0 | Uint16 |
| 9-67 | Control Word 1 | 0 N/A | All set-ups | | TRUE | 0 | OctStr[2] |
| 9-68 | Status Word 1 | 0 N/A | All set-ups | | TRUE | 0 | V2 |
| 9-71 | Profibus Save Data Values | [0] Off | All set-ups | | TRUE | - | Uint8 |
| 9-72 | ProfibusDriveReset | [0] No action | 1 set-up | | FALSE | - | Uint8 |
| 9-80 | Defined Parameters (1) | 0 N/A | All set-ups | | FALSE | 0 | Uint16 |
| 9-81 | Defined Parameters (2) | 0 N/A | All set-ups | | FALSE | 0 | Uint16 |
| 9-82 | Defined Parameters (3) | 0 N/A | All set-ups | | FALSE | 0 | Uint16 |
| 9-83 | Defined Parameters (4) | 0 N/A | All set-ups | | FALSE | 0 | Uint16 |
| 9-84 | Defined Parameters (5) | 0 N/A | All set-ups | | FALSE | 0 | Uint16 |
| 9-90 | Changed Parameters (1) | 0 N/A | All set-ups | | FALSE | 0 | Uint16 |
| 9-91 | Changed Parameters (2) | 0 N/A | All set-ups | | FALSE | 0 | Uint16 |
| 9-92 | Changed Parameters (3) | 0 N/A | All set-ups | | FALSE | 0 | Uint16 |
| 9-93 | Changed Parameters (4) | 0 N/A | All set-ups | | FALSE | 0 | Uint16 |
| 9-94 | Changed Parameters (5) | 0 N/A | All set-ups | | FALSE | 0 | Uint16 |
| 9-99 | Profibus Revision Counter | 0 N/A | All set-ups | | TRUE | 0 | Uint16 |

2.19.11. 10- CAN Ser. Com. Bus**

| Par. No. # | Parameter description | Default value | 4-set-up | FC 302 only | Change during operation | Conversion index | Type |
|-------------------------------|--------------------------------|-----------------|-------------|-------------|-------------------------|------------------|--------|
| 10-0* Common Settings | | | | | | | |
| 10-00 | CAN Protocol | null | 2 set-ups | | FALSE | - | Uint8 |
| 10-01 | Baud Rate Select | null | 2 set-ups | | TRUE | - | Uint8 |
| 10-02 | MAC ID | ExpressionLimit | 2 set-ups | | TRUE | 0 | Uint8 |
| 10-05 | Readout Transmit Error Counter | 0 N/A | All set-ups | | TRUE | 0 | Uint8 |
| 10-06 | Readout Receive Error Counter | 0 N/A | All set-ups | | TRUE | 0 | Uint8 |
| 10-07 | Readout Bus Off Counter | 0 N/A | All set-ups | | TRUE | 0 | Uint8 |
| 10-1* DeviceNet | | | | | | | |
| 10-10 | Process Data Type Selection | null | All set-ups | | TRUE | - | Uint8 |
| 10-11 | Process Data Config Write | ExpressionLimit | 2 set-ups | | TRUE | - | Uint16 |
| 10-12 | Process Data Config Read | ExpressionLimit | 2 set-ups | | TRUE | - | Uint16 |
| 10-13 | Warning Parameter | 0 N/A | All set-ups | | TRUE | 0 | Uint16 |
| 10-14 | Net Reference | [0] Off | 2 set-ups | | TRUE | - | Uint8 |
| 10-15 | Net Control | [0] Off | 2 set-ups | | TRUE | - | Uint8 |
| 10-2* COS Filters | | | | | | | |
| 10-20 | COS Filter 1 | 0 N/A | All set-ups | | FALSE | 0 | Uint16 |
| 10-21 | COS Filter 2 | 0 N/A | All set-ups | | FALSE | 0 | Uint16 |
| 10-22 | COS Filter 3 | 0 N/A | All set-ups | | FALSE | 0 | Uint16 |
| 10-23 | COS Filter 4 | 0 N/A | All set-ups | | FALSE | 0 | Uint16 |
| 10-3* Parameter Access | | | | | | | |
| 10-30 | Array Index | 0 N/A | 2 set-ups | | TRUE | 0 | Uint8 |
| 10-31 | Store Data Values | [0] Off | All set-ups | | TRUE | - | Uint8 |
| 10-32 | DeviceNet Revision | ExpressionLimit | All set-ups | | TRUE | 0 | Uint16 |
| 10-33 | Store Always | [0] Off | 1 set-up | | TRUE | - | Uint8 |
| 10-34 | DeviceNet Product Code | ExpressionLimit | 1 set-up | | TRUE | 0 | Uint16 |
| 10-39 | DeviceNet F Parameters | 0 N/A | All set-ups | | TRUE | 0 | Uint32 |
| 10-5* CANopen | | | | | | | |
| 10-50 | Process Data Config Write. | ExpressionLimit | 2 set-ups | | TRUE | - | Uint16 |
| 10-51 | Process Data Config Read. | ExpressionLimit | 2 set-ups | | TRUE | - | Uint16 |

2.19.12. 13-*-* Smart Logic

| Par. No. # | Parameter description | Default value | 4-set-up | FC 302 only | Change during operation | Conversion index | Type |
|---------------------------|-----------------------|----------------------|-------------|-------------|-------------------------|------------------|-------|
| 13-0* SLC Settings | | | | | | | |
| 13-00 | SL Controller Mode | null | 2 set-ups | | TRUE | - | Uint8 |
| 13-01 | Start Event | null | 2 set-ups | | TRUE | - | Uint8 |
| 13-02 | Stop Event | null | 2 set-ups | | TRUE | - | Uint8 |
| 13-03 | Reset SLC | [0] Do not reset SLC | All set-ups | | TRUE | - | Uint8 |
| 13-1* Comparators | | | | | | | |
| 13-10 | Comparator Operand | null | 2 set-ups | | TRUE | - | Uint8 |
| 13-11 | Comparator Operator | null | 2 set-ups | | TRUE | - | Uint8 |
| 13-12 | Comparator Value | ExpressionLimit | 2 set-ups | | TRUE | -3 | Int32 |
| 13-2* Timers | | | | | | | |
| 13-20 | SL Controller Timer | ExpressionLimit | 1 set-up | | TRUE | -3 | TimD |
| 13-4* Logic Rules | | | | | | | |
| 13-40 | Logic Rule Boolean 1 | null | 2 set-ups | | TRUE | - | Uint8 |
| 13-41 | Logic Rule Operator 1 | null | 2 set-ups | | TRUE | - | Uint8 |
| 13-42 | Logic Rule Boolean 2 | null | 2 set-ups | | TRUE | - | Uint8 |
| 13-43 | Logic Rule Operator 2 | null | 2 set-ups | | TRUE | - | Uint8 |
| 13-44 | Logic Rule Boolean 3 | null | 2 set-ups | | TRUE | - | Uint8 |
| 13-5* States | | | | | | | |
| 13-51 | SL Controller Event | null | 2 set-ups | | TRUE | - | Uint8 |
| 13-52 | SL Controller Action | null | 2 set-ups | | TRUE | - | Uint8 |

2.19.13. 14-** Special Functions

| Par. No. # | Parameter description | Default value | 4-set-up | FC 302 only | Change during operation | Conversion index | Type |
|----------------------------------|-------------------------------------|----------------------|-------------|-------------|-------------------------|------------------|--------|
| 14-0* Inverter Switching | | | | | | | |
| 14-00 | Switching Pattern | [1] SFAVM | All set-ups | | TRUE | - | Uint8 |
| 14-01 | Switching Frequency | null | All set-ups | | TRUE | - | Uint8 |
| 14-03 | Overmodulation | [1] On | All set-ups | | FALSE | - | Uint8 |
| 14-04 | PWM Random | [0] Off | All set-ups | | TRUE | - | Uint8 |
| 14-1* Mains On/Off | | | | | | | |
| 14-10 | Line Failure | [0] No function | All set-ups | | FALSE | - | Uint8 |
| 14-11 | Line Voltage at Line Fault | ExpressionLimit | All set-ups | | TRUE | 0 | Uint16 |
| 14-12 | Function at Mains Imbalance | [0] Trip | All set-ups | | TRUE | - | Uint8 |
| 14-2* Trip Reset | | | | | | | |
| 14-20 | Reset Mode | [0] Manual reset | All set-ups | | TRUE | - | Uint8 |
| 14-21 | Automatic Restart Time | 10 s | All set-ups | | TRUE | 0 | Uint16 |
| 14-22 | Operation Mode | [0] Normal operation | All set-ups | | TRUE | - | Uint8 |
| 14-23 | Typecode Setting | null | 2 set-ups | | FALSE | - | Uint8 |
| 14-25 | Trip Delay at Torque Limit | 60 s | All set-ups | | TRUE | 0 | Uint8 |
| 14-26 | Trip Delay at Inverter Fault | ExpressionLimit | All set-ups | | TRUE | 0 | Uint8 |
| 14-28 | Production Settings | [0] No action | All set-ups | | TRUE | - | Uint8 |
| 14-29 | Service Code | 0 N/A | All set-ups | | TRUE | 0 | Int32 |
| 14-3* Current Limit Ctrl. | | | | | | | |
| 14-30 | Current Lim Cont, Proportional Gain | 100 % | All set-ups | | FALSE | 0 | Uint16 |
| 14-31 | Current Lim Contr, Integration Time | 0.020 s | All set-ups | | FALSE | -3 | Uint16 |
| 14-4* Energy Optimizing | | | | | | | |
| 14-40 | VT Level | 66 % | All set-ups | | FALSE | 0 | Uint8 |
| 14-41 | AEO Minimum Magnetization | 40 % | All set-ups | | TRUE | 0 | Uint8 |
| 14-42 | Minimum AEO Frequency | 10 Hz | All set-ups | | TRUE | 0 | Uint8 |
| 14-43 | Motor Cos-Phi | ExpressionLimit | All set-ups | | TRUE | -2 | Uint16 |
| 14-5* Environment | | | | | | | |
| 14-50 | RFI 1 | [1] On | 1 set-up | x | FALSE | - | Uint8 |
| 14-52 | Fan Control | [0] Auto | All set-ups | | TRUE | - | Uint8 |
| 14-53 | Fan Monitor | [1] Warning | All set-ups | | TRUE | - | Uint8 |
| 14-55 | Output Filter | [0] No Filter | 1 set-up | | FALSE | - | Uint8 |
| 14-56 | Capactance Output Filter | 2.0 uF | 1 set-up | | FALSE | -7 | Uint16 |
| 14-57 | Inductance Output Filter | 7.000 mH | 1 set-up | | FALSE | -6 | Uint16 |
| 14-7* Compatibility | | | | | | | |
| 14-72 | VLT Alarm Word | 0 N/A | All set-ups | | FALSE | 0 | Uint32 |
| 14-73 | VLT Warning Word | 0 N/A | All set-ups | | FALSE | 0 | Uint32 |
| 14-74 | VLT Ext. Status Word | 0 N/A | All set-ups | | FALSE | 0 | Uint32 |

2.19.14. 15-*-* Drive Information

| Par. No. # | Parameter description | Default value | 4-set-up | FC 302 only | Change during operation | Conversion index | Type |
|-----------------------------------|-----------------------------|------------------|-------------|-------------|-------------------------|------------------|------------|
| 15-0* Operating Data | | | | | | | |
| 15-00 | Operating Hours | 0 h | All set-ups | | FALSE | 74 | Uint32 |
| 15-01 | Running Hours | 0 h | All set-ups | | FALSE | 74 | Uint32 |
| 15-02 | kWh Counter | 0 kWh | All set-ups | | FALSE | 75 | Uint32 |
| 15-03 | Power-ups | 0 N/A | All set-ups | | FALSE | 0 | Uint32 |
| 15-04 | Over Temps | 0 N/A | All set-ups | | FALSE | 0 | Uint16 |
| 15-05 | Over Volts | 0 N/A | All set-ups | | FALSE | 0 | Uint16 |
| 15-06 | Reset kWh Counter | [0] Do not reset | All set-ups | | TRUE | - | Uint8 |
| 15-07 | Reset Running Hours Counter | [0] Do not reset | All set-ups | | TRUE | - | Uint8 |
| 15-1* Data Log Settings | | | | | | | |
| 15-10 | Logging Source | 0 | 2 set-ups | | TRUE | - | Uint16 |
| 15-11 | Logging Interval | ExpressionLimit | 2 set-ups | | TRUE | -3 | TimD |
| 15-12 | Trigger Event | [0] FALSE | 1 set-up | | TRUE | - | Uint8 |
| 15-13 | Logging Mode | [0] Log always | 2 set-ups | | TRUE | - | Uint8 |
| 15-14 | Samples Before Trigger | 50 N/A | 2 set-ups | | TRUE | 0 | Uint8 |
| 15-2* Historic Log | | | | | | | |
| 15-20 | Historic Log: Event | 0 N/A | All set-ups | | FALSE | 0 | Uint8 |
| 15-21 | Historic Log: Value | 0 N/A | All set-ups | | FALSE | 0 | Uint32 |
| 15-22 | Historic Log: Time | 0 ms | All set-ups | | FALSE | -3 | Uint32 |
| 15-3* Fault Log | | | | | | | |
| 15-30 | Fault Log: Error Code | 0 N/A | All set-ups | | FALSE | 0 | Uint8 |
| 15-31 | Fault Log: Value | 0 N/A | All set-ups | | FALSE | 0 | Int16 |
| 15-32 | Fault Log: Time | 0 s | All set-ups | | FALSE | 0 | Uint32 |
| 15-4* Drive Identification | | | | | | | |
| 15-40 | FC Type | 0 N/A | All set-ups | | FALSE | 0 | VisStr[6] |
| 15-41 | Power Section | 0 N/A | All set-ups | | FALSE | 0 | VisStr[20] |
| 15-42 | Voltage | 0 N/A | All set-ups | | FALSE | 0 | VisStr[20] |
| 15-43 | Software Version | 0 N/A | All set-ups | | FALSE | 0 | VisStr[5] |
| 15-44 | Ordered Typecode String | 0 N/A | All set-ups | | FALSE | 0 | VisStr[40] |
| 15-45 | Actual Typecode String | 0 N/A | All set-ups | | FALSE | 0 | VisStr[40] |
| 15-46 | Adj Freq Dr Ordering No. | 0 N/A | All set-ups | | FALSE | 0 | VisStr[8] |
| 15-47 | Power Card Ordering No. | 0 N/A | All set-ups | | FALSE | 0 | VisStr[8] |
| 15-48 | LCP ID Num. | 0 N/A | All set-ups | | FALSE | 0 | VisStr[8] |
| 15-49 | SW ID Control Card | 0 N/A | All set-ups | | FALSE | 0 | VisStr[20] |
| 15-50 | SW ID Power Card | 0 N/A | All set-ups | | FALSE | 0 | VisStr[20] |
| 15-51 | Adj Freq Dr Serial No. | 0 N/A | All set-ups | | FALSE | 0 | VisStr[10] |
| 15-53 | Power Card Serial Number | 0 N/A | All set-ups | | FALSE | 0 | VisStr[19] |

| Par. No. # | Parameter description | Default value | 4-set-up | FC 302 only | Change during operation | Conver- sion index | Type |
|-----------------------------|---------------------------|---------------|-------------|----------------|----------------------------|-----------------------|-------------|
| 15-6* Option Ident | | | | | | | |
| 15-60 | Option Mounted | 0 N/A | All set-ups | | FALSE | 0 | VisStrf[30] |
| 15-61 | Option SW Version | 0 N/A | All set-ups | | FALSE | 0 | VisStrf[20] |
| 15-62 | Option Ordering No | 0 N/A | All set-ups | | FALSE | 0 | VisStrf[8] |
| 15-63 | Option Serial No | 0 N/A | All set-ups | | FALSE | 0 | VisStrf[18] |
| 15-70 | Option in Slot A | 0 N/A | All set-ups | | FALSE | 0 | VisStrf[30] |
| 15-71 | Slot A Option SW Version | 0 N/A | All set-ups | | FALSE | 0 | VisStrf[20] |
| 15-72 | Option in Slot B | 0 N/A | All set-ups | | FALSE | 0 | VisStrf[30] |
| 15-73 | Slot B Option SW Version | 0 N/A | All set-ups | | FALSE | 0 | VisStrf[20] |
| 15-74 | Option in Slot C0 | 0 N/A | All set-ups | | FALSE | 0 | VisStrf[30] |
| 15-75 | Slot C0 Option SW Version | 0 N/A | All set-ups | | FALSE | 0 | VisStrf[20] |
| 15-76 | Option in Slot C1 | 0 N/A | All set-ups | | FALSE | 0 | VisStrf[30] |
| 15-77 | Slot C1 Option SW Version | 0 N/A | All set-ups | | FALSE | 0 | VisStrf[20] |
| 15-9* Parameter Info | | | | | | | |
| 15-92 | Defined Parameters | 0 N/A | All set-ups | | FALSE | 0 | Uint16 |
| 15-93 | Modified Parameters | 0 N/A | All set-ups | | FALSE | 0 | Uint16 |
| 15-99 | Parameter Metadata | 0 N/A | All set-ups | | FALSE | 0 | Uint16 |

2.19.15. 16-*** Data Readouts

| Par. No. # | Parameter description | Default value | 4-set-up | FC 302 only | Change during operation | Conversion index | Type |
|---------------------------------|------------------------|-----------------------------|-------------|-------------|-------------------------|------------------|--------|
| 16-0* General Status | | | | | | | |
| 16-00 | Control Word | 0 N/A | All set-ups | | FALSE | 0 | V2 |
| 16-01 | Reference [Unit] | 0.000 ReferenceFeedbackUnit | All set-ups | | FALSE | -3 | Int32 |
| 16-02 | Reference % | 0.0 % | All set-ups | | FALSE | -1 | Int16 |
| 16-03 | Status Word | 0 N/A | All set-ups | | FALSE | 0 | V2 |
| 16-05 | Main Actual Value [%] | 0.00 % | All set-ups | | FALSE | -2 | N2 |
| 16-09 | Custom Readout | 0.00 CustomReadoutUnit | All set-ups | | FALSE | -2 | Int32 |
| 16-1* Motor Status | | | | | | | |
| 16-10 | Power [kW] | 0.00 kW | All set-ups | | FALSE | 1 | Int32 |
| 16-11 | Power [hp] | 0.00 hp | All set-ups | | FALSE | -2 | Int32 |
| 16-12 | Motor voltage | 0.0 V | All set-ups | | FALSE | -1 | UInt16 |
| 16-13 | Frequency | 0.0 Hz | All set-ups | | FALSE | -1 | UInt16 |
| 16-14 | Motor Current | 0.00 A | All set-ups | | FALSE | -2 | Int32 |
| 16-15 | Frequency [%] | 0.00 % | All set-ups | | FALSE | -2 | N2 |
| 16-16 | Torque [Nm] | 0.0 Nm | All set-ups | | FALSE | -1 | Int32 |
| 16-17 | Speed [RPM] | 0 RPM | All set-ups | | FALSE | 67 | Int32 |
| 16-18 | Motor Thermal | 0 % | All set-ups | | FALSE | 0 | UInt8 |
| 16-19 | KTY sensor temperature | 0 °C | All set-ups | | FALSE | 100 | Int16 |
| 16-20 | Motor Angle | 0 N/A | All set-ups | | TRUE | 0 | UInt16 |
| 16-22 | Torque [%] | 0 % | All set-ups | | FALSE | 0 | Int16 |
| 16-3* Drive Status | | | | | | | |
| 16-30 | DC Link Voltage | 0 V | All set-ups | | FALSE | 0 | UInt16 |
| 16-32 | Brake Energy/s | 0.000 kW | All set-ups | | FALSE | 0 | UInt32 |
| 16-33 | Brake Energy/2 min | 0.000 kW | All set-ups | | FALSE | 0 | UInt32 |
| 16-34 | Heatsink Temp. | 0 °C | All set-ups | | FALSE | 100 | UInt8 |
| 16-35 | Inverter Thermal | 0 % | All set-ups | | FALSE | 0 | UInt8 |
| 16-36 | Inv. Nom. Current | ExpressionLimit | All set-ups | | FALSE | -2 | UInt32 |
| 16-37 | Inv. Max. Current | ExpressionLimit | All set-ups | | FALSE | -2 | UInt32 |
| 16-38 | SL Controller State | 0 N/A | All set-ups | | FALSE | 0 | UInt8 |
| 16-39 | Control Card Temp. | 0 °C | All set-ups | | FALSE | 100 | UInt8 |
| 16-40 | Logging Buffer Full | [0] No | All set-ups | | TRUE | - | UInt8 |
| 16-5* Ref. & Feedsb. | | | | | | | |
| 16-50 | External Reference | 0.0 N/A | All set-ups | | FALSE | -1 | Int16 |
| 16-51 | Pulse Reference | 0.0 N/A | All set-ups | | FALSE | -1 | Int16 |
| 16-52 | Feedback [Unit] | 0.000 ReferenceFeedbackUnit | All set-ups | | FALSE | -3 | Int32 |
| 16-53 | Digi Pot. Reference | 0.00 N/A | All set-ups | | FALSE | -2 | Int16 |

| Par. No. # | Parameter description | Default value | 4-set-up | FC 302 only | Change during operation | Conver- sion index | Type |
|-------------------------------------|----------------------------|---------------|-------------|----------------|----------------------------|--------------------------|--------|
| 16-6* Inputs & Outputs | | | | | | | |
| 16-60 | Digital Input | 0 N/A | All set-ups | | FALSE | 0 | Uint16 |
| 16-61 | Terminal 53 Switch Setting | [0] Current | All set-ups | | FALSE | - | Uint8 |
| 16-62 | Analogue Input 53 | 0.000 N/A | All set-ups | | FALSE | -3 | Int32 |
| 16-63 | Terminal 54 Switch Setting | [0] Current | All set-ups | | FALSE | - | Uint8 |
| 16-64 | Analogue Input 54 | 0.000 N/A | All set-ups | | FALSE | -3 | Int32 |
| 16-65 | Analogue Output 42 [mA] | 0.000 N/A | All set-ups | | FALSE | -3 | Int16 |
| 16-66 | Digital Output [bin] | 0 N/A | All set-ups | | FALSE | 0 | Int16 |
| 16-67 | Freq. Input #29 [Hz] | 0 N/A | All set-ups | x | FALSE | 0 | Int32 |
| 16-68 | Freq. Input #33 [Hz] | 0 N/A | All set-ups | | FALSE | 0 | Int32 |
| 16-69 | Pulse Output #27 [Hz] | 0 N/A | All set-ups | | FALSE | 0 | Int32 |
| 16-70 | Pulse Output #29 [Hz] | 0 N/A | All set-ups | x | FALSE | 0 | Int32 |
| 16-71 | Relay Output [bin] | 0 N/A | All set-ups | | FALSE | 0 | Int16 |
| 16-72 | Counter A | 0 N/A | All set-ups | | TRUE | 0 | Int32 |
| 16-73 | Counter B | 0 N/A | All set-ups | | TRUE | 0 | Int32 |
| 16-74 | Prec. Stop Counter | 0 N/A | All set-ups | | TRUE | 0 | Uint32 |
| 16-75 | Analogue In X30/11 | 0.000 N/A | All set-ups | | FALSE | -3 | Int32 |
| 16-76 | Analogue In X30/12 | 0.000 N/A | All set-ups | | FALSE | -3 | Int32 |
| 16-77 | Analogue Out X30/8 [mA] | 0.000 N/A | All set-ups | | FALSE | -3 | Int16 |
| 16-8* Fieldbus & FC Port | | | | | | | |
| 16-80 | Fieldbus CTW 1 | 0 N/A | All set-ups | | FALSE | 0 | V2 |
| 16-82 | Fieldbus REF 1 | 0 N/A | All set-ups | | FALSE | 0 | N2 |
| 16-84 | Comm. Option Status | 0 N/A | All set-ups | | FALSE | 0 | V2 |
| 16-85 | FC Port CTW 1 | 0 N/A | All set-ups | | FALSE | 0 | V2 |
| 16-86 | FC Port REF 1 | 0 N/A | All set-ups | | FALSE | 0 | N2 |
| 16-9* Diagnosis Readouts | | | | | | | |
| 16-90 | Alarm Word | 0 N/A | All set-ups | | FALSE | 0 | Uint32 |
| 16-91 | Alarm word 2 | 0 N/A | All set-ups | | FALSE | 0 | Uint32 |
| 16-92 | Warning Word | 0 N/A | All set-ups | | FALSE | 0 | Uint32 |
| 16-93 | Warning word 2 | 0 N/A | All set-ups | | FALSE | 0 | Uint32 |
| 16-94 | Ext. Status Word | 0 N/A | All set-ups | | FALSE | 0 | Uint32 |

2.19.16. 17-*** Motor Feedb.Option

| Par. No. # | Parameter description | Default value | 4-set-up | FC 302 only | Change during operation | Conversion index | Type |
|----------------------------------|----------------------------|---------------------|-------------|-------------|-------------------------|------------------|--------|
| 17-1* Inc. Enc. Interface | | | | | | | |
| 17-10 | Signal Type | [1] TTL (5V, RS422) | All set-ups | | FALSE | - | Uint8 |
| 17-11 | Resolution (PPR) | 1024 N/A | All set-ups | | FALSE | 0 | Uint16 |
| 17-2* Abs. Enc. Interface | | | | | | | |
| 17-20 | Protocol Selection | [0] None | All set-ups | | FALSE | - | Uint8 |
| 17-21 | Resolution (Positions/Rev) | ExpressionLimit | All set-ups | | FALSE | 0 | Uint32 |
| 17-24 | SSI Data Length | 13 N/A | All set-ups | | FALSE | 0 | Uint8 |
| 17-25 | Clock Rate | ExpressionLimit | All set-ups | | FALSE | 3 | Uint16 |
| 17-26 | SSI Data Format | [0] Gray code | All set-ups | | FALSE | - | Uint8 |
| 17-34 | HIPERFACE Baud rate | [4] 9600 | All set-ups | | FALSE | - | Uint8 |
| 17-5* Resolver Interface | | | | | | | |
| 17-50 | Poles | 2 N/A | 1 set-up | | FALSE | 0 | Uint8 |
| 17-51 | Input Voltage | 7.0 V | 1 set-up | | FALSE | -1 | Uint8 |
| 17-52 | Input Frequency | 10.0 kHz | 1 set-up | | FALSE | 2 | Uint8 |
| 17-53 | Transformation Ratio | 0.5 N/A | 1 set-up | | FALSE | -1 | Uint8 |
| 17-59 | Resolver Interface | [0] Disabled | All set-ups | | FALSE | - | Uint8 |
| 17-6* Monitoring and App. | | | | | | | |
| 17-60 | Feedback Direction | [0] Clockwise | All set-ups | | FALSE | - | Uint8 |
| 17-61 | Feedback Signal Monitoring | [1] Warning | All set-ups | | TRUE | - | Uint8 |

2.19.17. 32-** MCO Basic Settings

| Par. No. # | Parameter description | Default value | 4-set-up | FC 302 only | Change during operation | Conversion index | Type |
|------------------------------|-----------------------------------|---------------------|-----------|-------------|-------------------------|------------------|--------|
| 32-0* Encoder 2 | | | | | | | |
| 32-00 | Incremental Signal Type | [1] TTL (5V, RS422) | 2 set-ups | | TRUE | - | Uint8 |
| 32-01 | Incremental Resolution | 1024 N/A | 2 set-ups | | TRUE | 0 | Uint32 |
| 32-02 | Absolute Protocol | [0] None | 2 set-ups | | TRUE | - | Uint8 |
| 32-03 | Absolute Resolution | 8192 N/A | 2 set-ups | | TRUE | 0 | Uint32 |
| 32-05 | Absolute Encoder Data Length | 25 N/A | 2 set-ups | | TRUE | 0 | Uint8 |
| 32-06 | Absolute Encoder Clock Frequency | 262.000 kHz | 2 set-ups | | TRUE | 0 | Uint32 |
| 32-07 | Absolute Encoder Clock Generation | [1] On | 2 set-ups | | TRUE | - | Uint8 |
| 32-08 | Absolute Encoder Cable Length | 0 m | 2 set-ups | | TRUE | 0 | Uint16 |
| 32-09 | Encoder Monitoring | [0] Off | 2 set-ups | | TRUE | - | Uint8 |
| 32-10 | Rotational Direction | [1] No action | 2 set-ups | | TRUE | - | Uint8 |
| 32-11 | User Unit Denominator | 1 N/A | 2 set-ups | | TRUE | 0 | Uint32 |
| 32-12 | User Unit Numerator | 1 N/A | 2 set-ups | | TRUE | 0 | Uint32 |
| 32-3* Encoder 1 | | | | | | | |
| 32-30 | Incremental Signal Type | [1] TTL (5V, RS422) | 2 set-ups | | TRUE | - | Uint8 |
| 32-31 | Incremental Resolution | 1024 N/A | 2 set-ups | | TRUE | 0 | Uint32 |
| 32-32 | Absolute Protocol | [0] None | 2 set-ups | | TRUE | - | Uint8 |
| 32-33 | Absolute Resolution | 8192 N/A | 2 set-ups | | TRUE | 0 | Uint32 |
| 32-35 | Absolute Encoder Data Length | 25 N/A | 2 set-ups | | TRUE | 0 | Uint8 |
| 32-36 | Absolute Encoder Clock Frequency | 262.000 kHz | 2 set-ups | | TRUE | 0 | Uint32 |
| 32-37 | Absolute Encoder Clock Generation | [1] On | 2 set-ups | | TRUE | - | Uint8 |
| 32-38 | Absolute Encoder Cable Length | 0 m | 2 set-ups | | TRUE | 0 | Uint16 |
| 32-39 | Encoder Monitoring | [0] Off | 2 set-ups | | TRUE | - | Uint8 |
| 32-40 | Encoder Termination | [1] On | 2 set-ups | | TRUE | - | Uint8 |
| 32-5* Feedback Source | | | | | | | |
| 32-50 | Source Slave | [2] Encoder 2 | 2 set-ups | | TRUE | - | Uint8 |

| Par. No. # | Parameter description | Default value | 4-set-up | FC 302 only | Change during operation | Conversion index | Type |
|------------------------------------|---|-----------------------|-----------|-------------|-------------------------|------------------|--------|
| 32-6* PID Controller | | | | | | | |
| 32-60 | Proportional factor | 30 N/A | 2 set-ups | | TRUE | 0 | Uint32 |
| 32-61 | Derivative factor | 0 N/A | 2 set-ups | | TRUE | 0 | Uint32 |
| 32-62 | Integral factor | 0 N/A | 2 set-ups | | TRUE | 0 | Uint32 |
| 32-63 | Limit Value for Integral Sum | 1000 N/A | 2 set-ups | | TRUE | 0 | Uint16 |
| 32-64 | PID Bandwidth | 1000 N/A | 2 set-ups | | TRUE | 0 | Uint16 |
| 32-65 | Velocity Feed-Forward | 0 N/A | 2 set-ups | | TRUE | 0 | Uint32 |
| 32-66 | Acceleration Feed-Forward | 0 N/A | 2 set-ups | | TRUE | 0 | Uint32 |
| 32-67 | Max. Tolerated Position Error | 20000 N/A | 2 set-ups | | TRUE | 0 | Uint32 |
| 32-68 | Reverse Behavior for Slave | [0] Reversing allowed | 2 set-ups | | TRUE | - | Uint8 |
| 32-69 | Sampling Time for PID Control | 1 ms | 2 set-ups | | TRUE | -3 | Uint16 |
| 32-70 | Scan Time for Profile Generator | 1 ms | 2 set-ups | | TRUE | -3 | Uint8 |
| 32-71 | Size of the Control Window (Activation) | 0 N/A | 2 set-ups | | TRUE | 0 | Uint32 |
| 32-72 | Size of the Control Window (Deactiv.) | 0 N/A | 2 set-ups | | TRUE | 0 | Uint32 |
| 32-8* Velocity & Accel. | | | | | | | |
| 32-80 | Maximum Velocity (Encoder) | 1500 RPM | 2 set-ups | | TRUE | 67 | Uint32 |
| 32-81 | Shortest Ramp | 1.000 s | 2 set-ups | | TRUE | -3 | Uint32 |
| 32-82 | Ramp Type | [0] Linear | 2 set-ups | | TRUE | - | Uint8 |
| 32-83 | Velocity Resolution | 100 N/A | 2 set-ups | | TRUE | 0 | Uint32 |
| 32-84 | Default Velocity | 50 N/A | 2 set-ups | | TRUE | 0 | Uint32 |
| 32-85 | Default Acceleration | 50 N/A | 2 set-ups | | TRUE | 0 | Uint32 |

2

2.19.18. 33- MCO Adv. Settings**

| Par. No. # | Parameter description | Default value | 4-set-up | FC 302 only | Change during operation | Conversion index | Type |
|------------------------------|-------------------------------------|------------------------|-----------|-------------|-------------------------|------------------|--------|
| 33-0* Home Motion | | | | | | | |
| 33-00 | Force HOME | [0] Home not forced | 2 set-ups | | TRUE | - | Uint8 |
| 33-01 | Zero Point Offset from Home Pos. | 0 N/A | 2 set-ups | | TRUE | 0 | Int32 |
| 33-02 | Ramp for Home Motion | 10 N/A | 2 set-ups | | TRUE | 0 | Uint32 |
| 33-03 | Velocity of Home Motion | 10 N/A | 2 set-ups | | TRUE | 0 | Int32 |
| 33-04 | Behavior during Home Motion | [0] Reverse and Index | 2 set-ups | | TRUE | - | Uint8 |
| 33-1* Synchronization | | | | | | | |
| 33-10 | Synchronization Factor Master (M:S) | 1 N/A | 2 set-ups | | TRUE | 0 | Int32 |
| 33-11 | Synchronization Factor Slave (M:S) | 1 N/A | 2 set-ups | | TRUE | 0 | Int32 |
| 33-12 | Position Offset for Synchronization | 0 N/A | 2 set-ups | | TRUE | 0 | Int32 |
| 33-13 | Accuracy Window for Position Sync. | 1000 N/A | 2 set-ups | | TRUE | 0 | Int32 |
| 33-14 | Relative Slave Velocity Limit | 0 % | 2 set-ups | | TRUE | 0 | Uint8 |
| 33-15 | Marker Number for Master | 1 N/A | 2 set-ups | | TRUE | 0 | Uint16 |
| 33-16 | Marker Number for Slave | 1 N/A | 2 set-ups | | TRUE | 0 | Uint16 |
| 33-17 | Master Marker Distance | 4096 N/A | 2 set-ups | | TRUE | 0 | Uint32 |
| 33-18 | Slave Marker Distance | 4096 N/A | 2 set-ups | | TRUE | 0 | Uint32 |
| 33-19 | Master Marker Type | [0] Encoder Z positive | 2 set-ups | | TRUE | - | Uint8 |
| 33-20 | Slave Marker Type | [0] Encoder Z positive | 2 set-ups | | TRUE | - | Uint8 |
| 33-21 | Master Marker Tolerance Window | 0 N/A | 2 set-ups | | TRUE | 0 | Uint32 |
| 33-22 | Slave Marker Tolerance Window | 0 N/A | 2 set-ups | | TRUE | 0 | Uint32 |
| 33-23 | Start Behavior for Marker Sync | [0] Start Function 1 | 2 set-ups | | TRUE | - | Uint16 |
| 33-24 | Marker Number for Fault | 10 N/A | 2 set-ups | | TRUE | 0 | Uint16 |
| 33-25 | Marker Number for Ready | 1 N/A | 2 set-ups | | TRUE | 0 | Uint16 |
| 33-26 | Velocity Filter | 0 us | 2 set-ups | | TRUE | -6 | Int32 |
| 33-27 | Offset Filter Time | 0 ms | 2 set-ups | | TRUE | -3 | Uint32 |
| 33-28 | Marker Filter Configuration | [0] Marker filter 1 | 2 set-ups | | TRUE | - | Uint8 |
| 33-29 | Filter Time for Marker Filter | 0 ms | 2 set-ups | | TRUE | -3 | Int32 |
| 33-30 | Maximum Marker Correction | 0 N/A | 2 set-ups | | TRUE | 0 | Uint32 |
| 33-31 | Synchronization Type | [0] Standard | 2 set-ups | | TRUE | - | Uint8 |
| 33-4* Limit Handling | | | | | | | |
| 33-40 | Behavior at End Limit Switch | [0] Call error handler | 2 set-ups | | TRUE | - | Uint8 |
| 33-41 | Negative Software End Limit | -500000 N/A | 2 set-ups | | TRUE | 0 | Int32 |
| 33-42 | Positive Software End Limit | 500000 N/A | 2 set-ups | | TRUE | 0 | Int32 |
| 33-43 | Negative Software End Limit Active | [0] Inactive | 2 set-ups | | TRUE | - | Uint8 |
| 33-44 | Positive Software End Limit Active | [0] Inactive | 2 set-ups | | TRUE | - | Uint8 |
| 33-45 | Time in Target Window | 0 ms | 2 set-ups | | TRUE | -3 | Uint8 |
| 33-46 | Target Window LimitValue | 1 N/A | 2 set-ups | | TRUE | 0 | Uint16 |
| 33-47 | Size of Target Window | 0 N/A | 2 set-ups | | TRUE | 0 | Uint16 |

| Par. No. # | Parameter description | Default value | 4-set-up | FC 302 only | Change during operation | Conversion index | Type |
|--------------------------------|--------------------------------|---------------------|-----------|-------------|-------------------------|------------------|-------|
| 33-5* I/O Configuration | | | | | | | |
| 33-50 | Terminal X57/1 Digital Input | [0] No function | 2 set-ups | | TRUE | - | UInt8 |
| 33-51 | Terminal X57/2 Digital Input | [0] No function | 2 set-ups | | TRUE | - | UInt8 |
| 33-52 | Terminal X57/3 Digital Input | [0] No function | 2 set-ups | | TRUE | - | UInt8 |
| 33-53 | Terminal X57/4 Digital Input | [0] No function | 2 set-ups | | TRUE | - | UInt8 |
| 33-54 | Terminal X57/5 Digital Input | [0] No function | 2 set-ups | | TRUE | - | UInt8 |
| 33-55 | Terminal X57/6 Digital Input | [0] No function | 2 set-ups | | TRUE | - | UInt8 |
| 33-56 | Terminal X57/7 Digital Input | [0] No function | 2 set-ups | | TRUE | - | UInt8 |
| 33-57 | Terminal X57/8 Digital Input | [0] No function | 2 set-ups | | TRUE | - | UInt8 |
| 33-58 | Terminal X57/9 Digital Input | [0] No function | 2 set-ups | | TRUE | - | UInt8 |
| 33-59 | Terminal X57/10 Digital Input | [0] No function | 2 set-ups | | TRUE | - | UInt8 |
| 33-60 | Terminal X59/1 and X59/2 Mode | [1] Output | 2 set-ups | | FALSE | - | UInt8 |
| 33-61 | Terminal X59/1 Digital Input | [0] No function | 2 set-ups | | TRUE | - | UInt8 |
| 33-62 | Terminal X59/2 Digital Input | [0] No function | 2 set-ups | | TRUE | - | UInt8 |
| 33-63 | Terminal X59/1 Digital Output | [0] No function | 2 set-ups | | TRUE | - | UInt8 |
| 33-64 | Terminal X59/2 Digital Output | [0] No function | 2 set-ups | | TRUE | - | UInt8 |
| 33-65 | Terminal X59/3 Digital Output | [0] No function | 2 set-ups | | TRUE | - | UInt8 |
| 33-66 | Terminal X59/4 Digital Output | [0] No function | 2 set-ups | | TRUE | - | UInt8 |
| 33-67 | Terminal X59/5 Digital Output | [0] No function | 2 set-ups | | TRUE | - | UInt8 |
| 33-68 | Terminal X59/6 Digital Output | [0] No function | 2 set-ups | | TRUE | - | UInt8 |
| 33-69 | Terminal X59/7 Digital Output | [0] No function | 2 set-ups | | TRUE | - | UInt8 |
| 33-70 | Terminal X59/8 Digital Output | [0] No function | 2 set-ups | | TRUE | - | UInt8 |
| 33-8* Global Parameters | | | | | | | |
| 33-80 | Activated Program Number | -1 N/A | 2 set-ups | | TRUE | 0 | Int8 |
| 33-81 | Power-up State | [1] Motor ON | 2 set-ups | | TRUE | - | UInt8 |
| 33-82 | Drive Status Monitoring | [1] On | 2 set-ups | | TRUE | - | UInt8 |
| 33-83 | Behavior After Error | [0] Coast | 2 set-ups | | TRUE | - | UInt8 |
| 33-84 | Behavior after Esc. | [0] Controlled stop | 2 set-ups | | TRUE | - | UInt8 |
| 33-85 | MCO Supplied by External 24VDC | [0] No | 2 set-ups | | TRUE | - | UInt8 |

2

2.19.19. 34-** MCO Data Readouts

| Par. No. # | Parameter description | Default value | 4-set-up | FC 302 only | Change during operation | Conversion index | Type |
|-----------------------------------|------------------------|---------------|-------------|-------------|-------------------------|------------------|--------|
| 34-0* PCD Write Par. | | | | | | | |
| 34-01 | PCD 1 Write to MCO | 0 N/A | All set-ups | | TRUE | 0 | Uint16 |
| 34-02 | PCD 2 Write to MCO | 0 N/A | All set-ups | | TRUE | 0 | Uint16 |
| 34-03 | PCD 3 Write to MCO | 0 N/A | All set-ups | | TRUE | 0 | Uint16 |
| 34-04 | PCD 4 Write to MCO | 0 N/A | All set-ups | | TRUE | 0 | Uint16 |
| 34-05 | PCD 5 Write to MCO | 0 N/A | All set-ups | | TRUE | 0 | Uint16 |
| 34-06 | PCD 6 Write to MCO | 0 N/A | All set-ups | | TRUE | 0 | Uint16 |
| 34-07 | PCD 7 Write to MCO | 0 N/A | All set-ups | | TRUE | 0 | Uint16 |
| 34-08 | PCD 8 Write to MCO | 0 N/A | All set-ups | | TRUE | 0 | Uint16 |
| 34-09 | PCD 9 Write to MCO | 0 N/A | All set-ups | | TRUE | 0 | Uint16 |
| 34-10 | PCD 10 Write to MCO | 0 N/A | All set-ups | | TRUE | 0 | Uint16 |
| 34-2* PCD Read Par. | | | | | | | |
| 34-21 | PCD 1 Read from MCO | 0 N/A | All set-ups | | TRUE | 0 | Uint16 |
| 34-22 | PCD 2 Read from MCO | 0 N/A | All set-ups | | TRUE | 0 | Uint16 |
| 34-23 | PCD 3 Read from MCO | 0 N/A | All set-ups | | TRUE | 0 | Uint16 |
| 34-24 | PCD 4 Read from MCO | 0 N/A | All set-ups | | TRUE | 0 | Uint16 |
| 34-25 | PCD 5 Read from MCO | 0 N/A | All set-ups | | TRUE | 0 | Uint16 |
| 34-26 | PCD 6 Read from MCO | 0 N/A | All set-ups | | TRUE | 0 | Uint16 |
| 34-27 | PCD 7 Read from MCO | 0 N/A | All set-ups | | TRUE | 0 | Uint16 |
| 34-28 | PCD 8 Read from MCO | 0 N/A | All set-ups | | TRUE | 0 | Uint16 |
| 34-29 | PCD 9 Read from MCO | 0 N/A | All set-ups | | TRUE | 0 | Uint16 |
| 34-30 | PCD 10 Read from MCO | 0 N/A | All set-ups | | TRUE | 0 | Uint16 |
| 34-4* Inputs & Outputs | | | | | | | |
| 34-40 | Digital Inputs | 0 N/A | All set-ups | | TRUE | 0 | Uint16 |
| 34-41 | Digital Outputs | 0 N/A | All set-ups | | TRUE | 0 | Uint16 |
| 34-5* Process Data | | | | | | | |
| 34-50 | Actual Position | 0 N/A | All set-ups | | TRUE | 0 | Int32 |
| 34-51 | Commanded Position | 0 N/A | All set-ups | | TRUE | 0 | Int32 |
| 34-52 | Actual Master Position | 0 N/A | All set-ups | | TRUE | 0 | Int32 |
| 34-53 | Slave Index Position | 0 N/A | All set-ups | | TRUE | 0 | Int32 |
| 34-54 | Master Index Position | 0 N/A | All set-ups | | TRUE | 0 | Int32 |
| 34-55 | Curve Position | 0 N/A | All set-ups | | TRUE | 0 | Int32 |
| 34-56 | Track Error | 0 N/A | All set-ups | | TRUE | 0 | Int32 |
| 34-57 | Synchronizing Error | 0 N/A | All set-ups | | TRUE | 0 | Int32 |
| 34-58 | Actual Velocity | 0 N/A | All set-ups | | TRUE | 0 | Int32 |
| 34-59 | Actual Master Velocity | 0 N/A | All set-ups | | TRUE | 0 | Int32 |
| 34-60 | Synchronizing Status | 0 N/A | All set-ups | | TRUE | 0 | Int32 |
| 34-61 | Axis Status | 0 N/A | All set-ups | | TRUE | 0 | Int32 |
| 34-62 | Program Status | 0 N/A | All set-ups | | TRUE | 0 | Int32 |
| 34-7* Diagnosis readouts | | | | | | | |
| 34-70 | MCO Alarm Word 1 | 0 N/A | All set-ups | | FALSE | 0 | Uint32 |
| 34-71 | MCO Alarm Word 2 | 0 N/A | All set-ups | | FALSE | 0 | Uint32 |

Index

1

| | |
|--------------------|-----|
| 10-1* Devicenet | 161 |
| 16-1* Motor Status | 211 |

2

| | |
|--------------|----|
| 24 V Encoder | 47 |
|--------------|----|

5

| | |
|---------------------|-----|
| 5-9* Bus Controlled | 121 |
|---------------------|-----|

A

| | |
|-----------------------------------|-----|
| Abbreviations | 4 |
| Access To Quick Menu W/o Password | 44 |
| Active Set-up | 30 |
| Actual Typecode String, 15-45 | 207 |
| Alarm Word | 142 |
| Alarm Word, 16-90 | 218 |
| Alarm Word, 16-91 | 219 |
| Analog Inputs | 6 |
| Analog Inputs | 6 |
| Automatic Motor Adaptation (ama) | 50 |
| Automatic Restart Time, 14-21 | 194 |

B

| | |
|---------------------------|-----|
| Back Emf At 1000 Rpm | 54 |
| Baud Rate | 25 |
| Brake Check | 71 |
| Brake Current | 74 |
| Brake Resistor (ohm) 2-11 | 70 |
| Braking Energy | 7 |
| Braking Energy | 71 |
| Braking Energy | 70 |
| Braking Energy Monitoring | 71 |
| Break-away Torque | 6 |
| Bus Jog 2 Speed | 147 |
| Bus Password Access | 45 |

C

| | |
|---|--------------|
| Catch Up | 106 |
| Catch Up/slow-down Value | 80 |
| Changing A Data Value | 22 |
| Changing A Group Of Numeric Data Values | 21 |
| Changing A Text Value | 21 |
| Changing Data | 20 |
| Clockwise | 60 |
| Clockwise | 94, 120, 223 |
| Coasting | 5, 14 |
| Coasting Select, 8-50 | 144 |
| Configurable Status Word Stw, 8-13 | 142 |
| Configuration Mode | 46 |
| Control Site, 8-01 | 139 |
| Control Word Timeout Function | 140 |
| Cooling | 63 |
| Counter-clockwise | 94 |

| | |
|--|---------|
| Current Lim Cont, 14-30 | 196 |
| Current Lim. Contr., Int. Time, 14-31 | 196 |
| D | |
| Data Log Settings, 15-1* | 201 |
| D-axis Inductance (Id) | 53 |
| Dc Brake | 69 |
| Dc Brake Select, 8-52 | 145 |
| Dc Braking Time | 70 |
| Dc Hold | 60, 62 |
| Dc Hold | 69 |
| Dc Link Voltage | 213 |
| Default Settings | 224 |
| Default Settings | 25 |
| Defined Parameters, 15-92 | 209 |
| Definitions | 4 |
| Devicenet And Can Serial Communication Bus | 160 |
| Devicenet F Parameters 10-39 | 168 |
| Digital Input, 16-60 | 215 |
| Display Line 2 Large | 38 |
| Display Line 3 Large, 0-24 | 38 |
| Display Mode | 16 |
| Display Mode - Selection Of Readouts | 16 |
| Drive Identification, 15-4* | 207 |
| Drive Information | 200 |
| Drive Ordering Number, 15-46 | 207 |
| Drive Serial No., 15-51 | 208 |
| E | |
| Electronic Terminal Relay | 66 |
| Encoder Positive Direction | 223 |
| Encoder Pulses | 120 |
| Encoder Signal Monitoring | 223 |
| End-of-timeout Function, 8-05 | 141 |
| Environment, 14-5* | 197 |
| Etr | 64, 212 |
| Ext. Status Word | 219 |
| External Reference | 214 |
| F | |
| Fan Monitor, 14-53 | 198 |
| Fault Log, 15-3* | 206 |
| Fault Log: Error Code | 206 |
| Fault Log: Time, 15-32 | 206 |
| Fault Log: Value, 15-31 | 206 |
| Flying Start | 61 |
| Freeze Output | 5 |
| Freq. Input #33 [hz] | 216 |
| Function At Stop | 62 |
| G | |
| General Warning | 3 |
| Graphical Display | 11 |
| H | |
| Heatsink Temp. | 213 |
| Hist. Log: Time, 15-22 | 205 |
| Hist. Log: Value, 15-21 | 205 |

| | |
|--|------------------|
| Historic Log,15-2* | 205 |
| Historic Log: Event, 15-20 | 205 |
| I | |
| Incremental Encoder | 214 |
| Indexed Parameters | 22 |
| Infinitely Variable Change Of Numeric Data Value | 21 |
| Initialization | 25 |
| Inverter Switching, 14-0* | 190 |
| Iron Loss Resistance (rfe) | 53 |
| It Line Power | 198 |
| J | |
| Jog | 5 |
| Jog Ramp Time | 91 |
| Jog Speed | 80, 83 |
| K | |
| Kwh Counter, 15-02 | 200 |
| L | |
| Language | 28 |
| Language Package 1 | 28 |
| Language Package 2 | 28 |
| Language Package 3 | 28 |
| Language Package 4 | 28 |
| Lcp | 5, 7, 11, 15, 23 |
| Lcp 102 | 11 |
| Lcp Copy | 43 |
| Lcp Id No, 15-48 | 208 |
| Lcp Id No. | 208 |
| Lcp Keypad, 0-4* | 42 |
| Leds | 11, 12 |
| Line Failure | 191 |
| Line Power Rfi Filter Circuit | 198 |
| Line Supply | 9 |
| Line Voltage At Line Fault, 14-11 | 192 |
| Live Zero Timeout Time, 6-00 | 123 |
| Load Type | 59 |
| Local Control Keys | 24 |
| Local Reference | 30 |
| Logging Interval, 15-11 | 203 |
| Logging Mode, 15-13 | 204 |
| M | |
| Main Actual Value [%], 16-05 | 210 |
| Main Menu | 17 |
| Main Menu Mode | 13 |
| Main Menu Mode | 20 |
| Main Reactance | 50 |
| Main Reactance (xh) | 52 |
| Max Output Frequency | 96 |
| Maximum Inertia | 59 |
| Maximum Limit | 93 |
| Maximum Reference | 79 |
| Min. Frequency For Function At Stop, 1-81 | 62 |
| Min. Speed For Function At Stop [hz], 1-82 | 62 |
| Minimum Aeo Frequency, 14-42 | 197 |

| | |
|---------------------------------------|---------|
| Minimum Inertia | 59 |
| Minimum Limit | 93 |
| Minimum Magnetization, 14-41 | 197 |
| Missing Motor Phase Function, 4-58 | 100 |
| Modified Parameters, 15-93 | 209 |
| Motor Angle Offset | 54 |
| Motor Cont. Rated Torque | 50 |
| Motor Current | 49 |
| Motor Feedback | 46 |
| Motor Frequency | 49, 211 |
| Motor Magnetizing At Zero Speed, 1-50 | 54 |
| Motor Nominal Speed | 50 |
| Motor Poles | 53 |
| Motor Power | 49 |
| Motor Power [hp] | 49 |
| Motor Protection | 63 |
| Motor Speed High Limit [hz], 4-14 | 95 |
| Motor Speed Unit | 29 |
| Motor Thermal Protection | 63 |
| Motor Voltage | 49, 211 |
| | |
| N | |
| Net Control 10-15 | 166 |
| Net Reference 10-14 | 166 |
| Normal Torque | 48 |
| Numerical Local Control Panel | 23 |
| | |
| O | |
| Operating Hours, 15-00 | 200 |
| Operating Mode | 30 |
| Operating State At Power-up (hand) | 30 |
| Operation Mode | 194 |
| Option Ident. 15-6* | 208 |
| Option Mounted, 15-60 | 208 |
| Option Ordering No., 15-62 | 209 |
| Option Serial No., 15-63 | 209 |
| Option Sw Version, 15-61 | 208 |
| Ordered Type Code String, 15-44 | 207 |
| Output Filter, 14-55 | 198 |
| Output Speed | 60 |
| Overtmps, 15-04 | 200 |
| Overvoltage Control | 73 |
| Overvolts, 15-05 | 200 |
| | |
| P | |
| Parameter Access | 167 |
| Parameter Info, 15-9* | 209 |
| Parameter Selection | 20 |
| Parameter Set-up | 17 |
| Passive Load | 59 |
| Power Card Ordering No, 15-47 | 207 |
| Power Card Serial No., 15-53 | 208 |
| Power Hp, 16-11 | 211 |
| Power Restore | 93 |
| Power-ups, 15-03 | 200 |
| Precise Stop | 63 |
| Precise Stop Counter | 217 |
| Precise Stop Function | 62 |
| Pre-magnetizing | 62 |
| Preset Reference | 79 |

| | |
|---|-----|
| Preset Reference Select, 8-56 | 147 |
| Process Control, 9-28 | 153 |
| Profibus Warning Word | 154 |
| Proportional Gain | 133 |
| Pulse Filter Time Constant #33, 5-59 | 117 |
| Pulse Input 29, 16-67 | 216 |
| Pulse Output Maximum Frequency #29, 5-65 | 119 |
| Pulse Output Maximum Frequency #x30/6, 5-68 | 119 |
| Pulse Reference | 214 |
| Pwm Random, 14-04 | 190 |

Q

| | |
|---|--------|
| Quick Menu | 13, 17 |
| Quick Menu Mode | 13, 17 |
| Quick Menu Password | 44 |
| Quick Stop Ramp Time | 91 |
| Quick Stop Select | 144 |
| Quick Transfer Of Parameter Settings Between Multiple Adjustable Frequency Drives | 15 |

R

| | |
|-----------------------------------|-----|
| Ramp 1 Ramp-down Time | 85 |
| Ramp 1 Ramp-up Time | 85 |
| Ramp 1 Type | 84 |
| Ramp 2 Ramp-down Time | 87 |
| Ramp 3 Ramp-down Time | 88 |
| Ramp 3 Ramp-up Time | 88 |
| Ramp 4 Ramp-down Time | 90 |
| Ramp Delay | 93 |
| Ramp Time | 93 |
| Rated Motor Speed | 5 |
| Rcd | 8 |
| Reference Source 1 | 81 |
| Regional Settings | 29 |
| Relative Scaling Reference Source | 82 |
| Relay Outputs | 110 |
| Reset | 14 |
| Reset Control Word Timeout | 141 |
| Reset Kwh Counter, 15-06 | 201 |
| Reset Mode, 14-20 | 193 |
| Reset] Key On Lcp | 42 |
| Rfi, 14-50 | 197 |
| Rotor Leakage Reactance (x2) | 52 |
| Rotor Resistance (rr) | 52 |
| Running Hours, 15-01 | 200 |

S

| | |
|--------------------------------|-----|
| Serial Communication | 6 |
| SI Controller Mode, 13-00 | 169 |
| Special Functions | 190 |
| Speed Pid Feed Forward Factor | 135 |
| Speed Pid Low-pass Filter Time | 134 |
| Start Delay | 60 |
| Start Delay | 59 |
| Start Function | 60 |
| Start Function | 60 |
| Start Select, 8-53 | 145 |
| Start Speed [hz] | 61 |
| Start Speed [rpm] | 61 |
| Stator Leakage Reactance | 50 |
| Stator Leakage Reactance (x1) | 52 |

| | |
|--|---------|
| Stator Resistance (rs) | 51 |
| Status | 13 |
| Status Messages | 11 |
| Step Size | 92 |
| Step-by-step | 22 |
| Store Always 10-33 | 168 |
| Store Data Values 10-31 | 167 |
| Sw Id Control Card, 15-49 | 208 |
| Sw Id Power Card, 15-50 | 208 |
| Sw Version, 15-43 | 207 |
| Switching Frequency | 190 |
| T | |
| Term 32/33 Encoder Direction | 120 |
| Term. 29 Low Frequency | 116 |
| Term. 33 Low Frequency, 5-55 | 117 |
| Terminal 33 High Frequency, 5-56 | 117 |
| Terminal 33 Low Ref./feedb. Value, 5-57 | 117 |
| Terminal 42 Output Min Scale, 6-51 | 129 |
| Terminal 53 High Current | 125 |
| Terminal 53 High Voltage, 6-11 | 124 |
| Terminal 53 Low Current | 125 |
| Terminal 54 High Current | 126 |
| Terminal 54 Low Current | 126 |
| Terminal 54 Switch Setting, 16-63 | 215 |
| Terminal X30/6 Pulse Output Variable, 5-66 | 119 |
| Thermal Load | 54, 212 |
| Thermistor | 64 |
| Thermistor | 8 |
| Thermistor Source, 1-93 | 66 |
| Torque Limit Generator Mode | 96 |
| Trip Delay At Torque Limit | 195 |
| Trip Reset, 14-2* | 193 |
| V | |
| Variable Torque | 47 |
| Vt Level, 14-40 | 197 |
| Vvcplus | 9, 46 |
| W | |
| Warning Word 2 | 219 |
| Warning Word, 16-92 | 219 |



www.danfoss.com/drives

Danfoss shall not be responsible for any errors in catalogs, brochures or other printed material. Danfoss reserves the right to alter its products at any time without notice, provided that alterations to products already on order shall not require material changes in specifications previously agreed upon by Danfoss and the Purchaser. All trademarks in this material are property of the respective companies. Danfoss and the Danfoss logotype are trademarks of Danfoss A/S. All rights reserved.

For: Industrial Sales, Application Engineering

Danfoss Drives

Division of Danfoss Inc.
4401 N. Bell School Road
Loves Park, IL, 61111
Toll free: 800/432-6367
Telephone: 815/639-8600
Fax: 815/639-8000
www.namc.danfoss.com

